

**APPENDIX I:
PARKING AND TRANSPORTATION DATA**





Hamptons Apartment Complex

Final Transportation Impact Analysis

Prepared by
FEHR & PEERS

160 W. Santa Clara Street
Suite 675
San José, CA 95113

Franziska Church, AICP
f.church@fehrandpeers.com
408.645.7014

Hamptons Apartment Complex

Final Transportation Impact Analysis

Prepared for:
City of Cupertino
& Placeworks

December 2015

SJ15-1612

FEHR  PEERS

Table of Contents

EXECUTIVE SUMMARY	I
1. INTRODUCTION.....	1
1.1 Project Description	1
1.2 Study Area.....	1
1.2.1 Study Intersections	4
1.2.2 Freeway Segments	5
1.2.3 Pedestrian, Bicycle, and Transit Facilities	5
1.3 Analysis Scenarios.....	5
1.4 Analysis Methods.....	5
1.4.1 Signalized Intersections	6
1.4.2 Freeway Segments	6
1.5 Level of Service Standards and Impact Criteria.....	7
1.5.1 Signalized Intersections	7
1.5.2 Freeway Segments	9
1.6 Report Organization	9
2. EXISTING CONDITIONS	10
2.1 Existing Roadway Network.....	10
2.2 Pedestrian Facilities.....	11
2.3 Bicycle Facilities.....	12
2.4 Transit Service.....	17
2.4.1 VTA Bus Service.....	17
2.4.2 Commuter Rail Service	17
2.5 Existing Intersection Volumes and Lane Configurations.....	20
2.6 Existing Intersection Level of Service	20
2.7 Existing Freeway Segment Level of Service	23
3. PROJECT TRAFFIC ESIMATES.....	24
3.1 Trip Generation	24
3.1.1 Trip Reductions	24

3.1.2	Trip Estimates.....	25
3.2	Trip Distribution and Trip Assignment	25
4.	EXISTING PLUS PROJECT CONDITIONS	28
4.1	Existing plus Project Volumes	28
4.2	Existing plus Project Intersection Level of Service	28
4.3	Existing plus Project Intersection Impacts and Mitigation measures.....	32
4.4	Existing plus Project Freeway Segment Level of Service	32
4.5	Existing plus Project Freeway Segment Impacts and Mitigation Measures	32
5.	BACKGROUND CONDITIONS	34
5.1	Background Traffic Volumes.....	34
5.2	Background plus Project Traffic Volumes	34
5.3	Background Intersection Level of Service	34
5.4	Background Intersection Impacts and Mitigation Measures.....	34
6.	CONSTRUCTION TRIP GENERATION ESTIMATES	39
7.	SITE ACCESS, ON-SITE CIRCULATION, MULTI-MODAL TRANSPORTATION, AND PARKING ASSESSMENT.....	40
7.1	Vehicle Access and Circulation Review.....	40
7.2	Pedestrian Access and Circulation	40
7.3	Bicycle Access and Circulation	40
7.4	Transit Evaluation.....	41
7.4.1	Transit Site Access.....	41
7.4.2	Transit Vehicle Capacity.....	41
7.4.3	Transit Vehicle Delay (For Informational Purposes).....	41
7.4.4	Transit Impacts	42
7.5	Parking Assessment	42
7.5.1	Vehicle Parking.....	42
7.5.2	Bicycle Parking.....	43



Appendices

- Appendix A: Existing Traffic Counts
- Appendix B: Intersection Level of Service Calculations
- Appendix C: Approved, Not Occupied, and Pending Projects

List of Figures

Figure 1-1: Study Area	2
Figure 1-2: Site Plan.....	3
Figure 2-1: Existing Pedestrian Facilities	15
Figure 2-2: Existing Bicycle Facilities	16
Figure 2-3: Existing Transit Map	19
Figure 2-4: Existing Peak Hour Traffic Volumes, Lane Configurations, and Traffic Control Devices	22
Figure 3-1: Project Trip Distribution	26
Figure 3-2: Project Trip Assignment	27
Figure 4-1: Existing plus Project Peak Hour Traffic Volumes and Lane Configurations	29
Figure 5-1: Background Peak Hour Traffic Volumes and Lane Configurations	35
Figure 5-2: Background plus Project Peak Hour Traffic Volumes and Lane Configurations	36



List of Tables

Table 1-1: Study Intersections.....	4
Table 1-2: Signalized Intersection Level of Service Definitions.....	6
Table 1-3: Freeway Segment Level of Service Definitions.....	7
Table 1-4: Signalized Intersection LOS Standards.....	7
Table 2-1: Existing Transit Service.....	18
Table 2-2: Existing Intersection Level of Service Results	20
Table 2-3: Existing Freeway (I-280) Level of Service Results	23
Table 3-1: Trip Generation Rate Comparison.....	24
Table 3-2: Hamptons Vehicle Trip Generation Estimates.....	25
Table 4-1: Existing Plus Project Intersection Level of Service Results	30
Table 4-2: Existing Freeway (I-280) Level of Service REsults	33
Table 5-1: Background Plus Project Intersection Level of Service Results.....	37
Table 6-1: Construction Traffic Trip Generation Estimates	39
Table 7-1: Transit Vehicle Delay	41

EXECUTIVE SUMMARY

This report presents the results of the transportation impact analysis (TIA) for the proposed redevelopment of the Hamptons Apartment Complex (the Project) located at 19500 Pruneridge Avenue in City of Cupertino, California. The Project proposes to expand the number of units from 342 units to 942 units. The City of Cupertino recently adopted their new General Plan (Community Vision 2015-2040), which allocated an increase of 820 housing units for the site (the project proposes to increase the number of units by 600). The cumulative impacts, in conjunction with overall General Plan buildout was evaluated as part of the General Plan's EIR; thus this report presents a focused analysis to evaluate the near-term impacts of the Project under Existing and Background Conditions.

PROJECT TRAFFIC ESTIMATES

The Project is estimated to generate 272 net new AM peak hour vehicle trips (48 inbound and 224 outbound) and 421 net new PM peak hour vehicle trips (268 inbound and 153 outbound).

INTERSECTION IMPACTS AND MITIGATION MEASURES

Intersection impacts were evaluated Existing and Background Conditions.

EXISTING PLUS PROJECT CONDITIONS

Based on the impact criteria presented in Chapter 1.5, the Project is expected to have a **less-than-significant** impact at all 16 study intersections evaluated in this TIA under Existing plus Project conditions.

BACKGROUND PLUS PROJECT CONDITIONS

Based on the impact criteria presented in Chapter 1.5, the Project is expected to have a **less-than-significant** impact at all 16 study intersections evaluated in this TIA under Background plus Project conditions.

FREEWAY IMPACTS AND MITIGATION MEASURES

Freeway impacts are evaluated under the Existing plus Project Conditions only. Under this scenario, the Project would not degrade acceptable operating segments to unacceptable levels and would not add trips greater than one percent of the freeway capacity to the freeway study segments operating unacceptably during the AM and PM peak hours. Therefore, the Project would have a **less-than-significant** freeway impact based on VTA's impact criteria.



SITE ACCESS AND CIRCULATION

The site plan, dated September 2015, illustrates the locations of the project driveway and internal circulation system for auto, pedestrian, and bicycle traffic. The only access to the Project is located off of Pruneridge Avenue which provides immediate access to the Hamptons Apartments parking structure. The driveway includes two access lanes for entry in the garage, one for residents and one for visitors. Exit lanes are provided adjacent to the entry lanes. Vehicle circulation around the perimeter is exclusively designated for emergency vehicles, moving trucks, and garbage trucks.

PEDESTRIAN AND BICYCLE FACILITIES

Sidewalks are provided along the perimeter of the project site to the west along Wolfe Road and to the north along Pruneridge Avenue. Pedestrian signals and high visibility crosswalks are provided at the Wolfe Road and Pruneridge Avenue intersection immediately adjacent to the project site. At this intersection, pedestrians are able to cross the street in both the north-south and east-west direction. Near the study area, bicycle lanes are provided on main arterials such as Blaney Avenue between Homestead Road and Bollinger Road, Wolfe Road, Homestead Road, Tantau Avenue, Vallco Parkway, and Stevens Creek Boulevard.

VEHICLE AND BICYCLE PARKING

Based on the requirements of City of Cupertino, the Project is required to provide 1,884 vehicle parking spaces. The Project proposes to provide 1,716 vehicle parking spaces, which is less than the required amount. Although the Project provides less than the required amount of vehicle spaces, the Hamptons Apartment Complex also has a high amount of one bedroom and studio units. These types of housing units represent 68% of the total mix which help justify providing less parking. For bicycle parking, the Hamptons is required to provide 377 Class I bicycle spaces, which the Project proposes meet.



1. INTRODUCTION

This report presents the findings of the Hamptons Apartment Complex Transportation Impact Analysis (TIA). The 12.4-acre apartment complex is located in Cupertino, California at the southeast corner of the Wolfe Road/Pruneridge Avenue intersection directly adjacent to the new Apple Campus 2 (currently under construction). The purpose of this analysis is to identify potentially significant adverse impacts of the Project on the surrounding transportation system and to recommend measures to mitigate significant impacts. The increased housing density at the Hamptons' site was recently evaluated as part of the City of Cupertino's General Plan Amendment and associated Environmental Impact Report (EIR). Thus this analysis tiers off of the General Plan EIR and focuses on Existing and Background Conditions with and without the Project.

The TIA was prepared following the guidelines of the City of Cupertino and Santa Clara Valley Transportation Authority (VTA, the congestion management agency for Santa Clara County. The VTA Congestion Management Program (CMP) TIA Guidelines (last updated in October 2014) present guidelines for assessing the transportation impacts of development projects and identifying whether improvements are needed to adjacent roadways, bike facilities, sidewalks, and transit services affected by the Project. The TIA guidelines have been adopted by local agencies within Santa Clara County, and are applied to analyze the regional transportation system.

1.1 PROJECT DESCRIPTION

The Hamptons Apartments currently has 342 units and is proposing to redevelop the site and increase the number of dwelling units by 600 units to a total of 942 units. For comparison purposes, the General Plan Amendment, Housing Element Update and Associated Rezoning EIR contemplated an increase of 850 units at this site.

The site is generally bounded by Pruneridge Avenue to the north, Apple Campus 2 to the east, I-280 to the south, and Wolfe Road to the west. The site location and study area are shown in **Figure 1-1**. The proposed site plan is presented in **Figure 1-2**.

1.2 STUDY AREA

The study area generally extends along Wolfe Road between El Camino Real (State Route (SR) 82) and Stevens Creek Boulevard and along Tantau Avenue between Homestead Road and Stevens Creek Boulevard. The roadway impacts of the proposed Project were evaluated for the intersections and freeway segments discussed below.



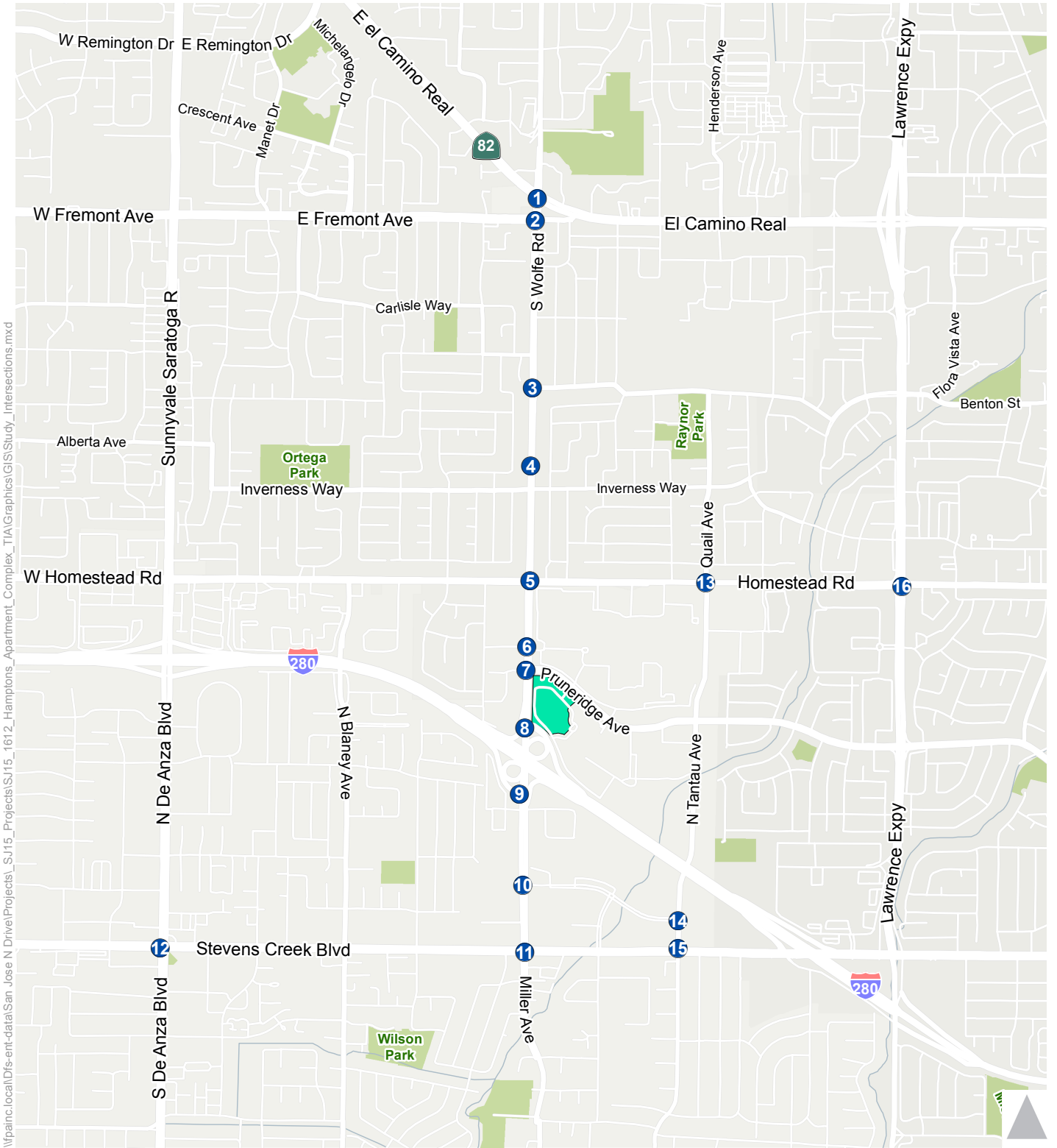

\\painsc.local\dfs-ent-data\San Jose N Drive\Projects\SJ15_1612_Hampton_Apartment_Complex_TIA\Graphics\GIS\Study_Intersections.mxd

- Project Site
- Study Intersections



Figure 1-1
Study Area

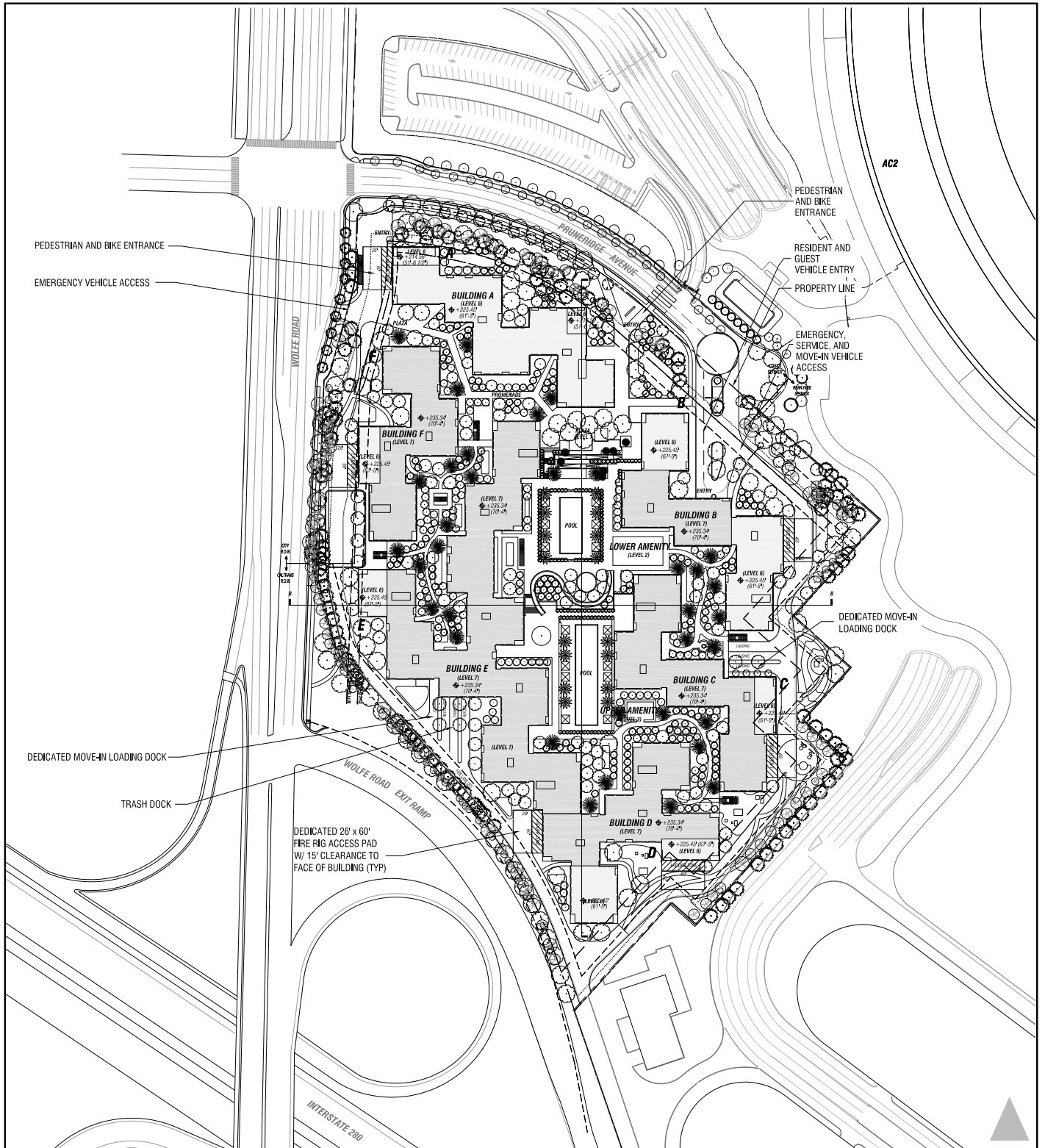

Site Plan Source: Architectonica, January 2016



Figure 1-2
Site Plan

1.2.1 STUDY INTERSECTIONS

The list of study intersections is presented in **Table 1-1**. Study intersections were selected in consultation with the City of Cupertino and generally determined based on VTA's 10 trips per lane guideline, which indicates that intersections should be included if the Project adds 10 or more peak hour vehicles per lane to any intersection movement.

TABLE 1-1: STUDY INTERSECTIONS

ID #	Intersection	Jurisdiction / CMP ¹
1	Wolfe Road / El Camino Real	Sunnyvale (CMP)
2	Wolfe Road / Fremont Avenue	Sunnyvale
3	Wolfe Road / Marion Way	Sunnyvale
4	Wolfe Road / Inverness Avenue	Sunnyvale
5	Wolfe Road / Homestead Road	Cupertino
6	Wolfe Road / Apple Campus 2	Cupertino
7	Wolfe Road / Pruneridge Avenue	Cupertino
8	Wolfe Road / I-280 Northbound (NB) Ramps	Cupertino (CMP)
9	Wolfe Road / I-280 Southbound (SB) Ramps	Cupertino (CMP)
10	Wolfe Road / Vallco Parkway	Cupertino
11	Wolfe Road / Stevens Creek Boulevard	Cupertino (CMP)
12	De Anza Boulevard / Stevens Creek Boulevard	Cupertino (CMP)
13	Tantau Avenue / Homestead Road	Cupertino
14	Tantau Avenue / Vallco Parkway	Cupertino
15	Tantau Avenue / Stevens Creek Boulevard	Cupertino
16	Lawrence Expressway / Homestead Road	Santa Clara County (CMP)

Notes:

1. Congestion Management Program (CMP) indicates the intersection is part of VTA's CMP monitoring program.

Source: Fehr & Peers, 2015.



1.2.2 FREEWAY SEGMENTS

Freeway segments were also selected in consultation with the City of Cupertino following VTA guidelines. The following segments on I-280 were selected for analysis because: a) the project site is adjacent to I-280, b) project access is provided with the Wolfe Road interchange at I-280, and c) the project is anticipated to add peak-hour traffic volumes in amounts greater than one percent of the segment's capacity.

I-280 (Northbound and Southbound)

- Saratoga Avenue to Lawrence Expressway
- Lawrence Expressway to Wolfe Road
- Wolfe Road to De Anza Boulevard
- De Anza Boulevard to SR 85

1.2.3 PEDESTRIAN, BICYCLE, AND TRANSIT FACILITIES

Project impacts to pedestrian facilities within approximately a quarter-mile radius and bicycle facilities and transit service within approximately half-mile radius from the Project site are also addressed.

1.3 ANALYSIS SCENARIOS

The operations of the study intersections were evaluated during the weekday morning (AM) and weekday evening (PM) peak hours for the following scenarios:

Scenario 1: Existing Conditions – Existing volumes obtained from counts.

Scenario 2: Existing plus Project Conditions – Scenario 1 volumes plus traffic generated by the added units in the proposed Project.

Scenario 3: Background Conditions – Existing volumes plus traffic from “approved but not yet built” and “not occupied” developments in the area.

Scenario 4: Background plus Project Conditions – Scenario 3 volumes plus traffic generated by the proposed Project.

Freeway segments were analyzed following the VTA guidelines under the Existing and Existing plus Project scenarios.

1.4 ANALYSIS METHODS

The operations of roadway facilities are described with the term *level of service*. Level of Service (LOS) is a qualitative description of traffic flow based on factors such as speed, travel time, delay, and freedom to



maneuver. Six levels are defined from LOS A, the best operating conditions, to LOS F, the worst operating conditions. LOS E represents “at-capacity” operations. When traffic volumes exceed the intersection capacity, stop-and-go conditions result, and operations are designated as LOS F.

1.4.1 SIGNALIZED INTERSECTIONS

The method described in Chapter 16 of the 2000 *Highway Capacity Manual* (2000 HCM) (Special Report 209, Transportation Research Board) was used to prepare the level of service calculations for the study intersections. This level of service method, which is approved by the City of Cupertino, City of Sunnyvale, and VTA, analyzes a signalized intersection’s operation based on average control delay per vehicle. Control delay includes the initial deceleration delay, queue move-up time, stopped delay, and final acceleration delay. The average control delay for signalized intersections is calculated using TRAFFIX analysis software and is correlated to a LOS designation as shown in **Table 1-2**.

TABLE 1-2: SIGNALIZED INTERSECTION LEVEL OF SERVICE DEFINITIONS

Level of Service	Description	Average Control Delay per Vehicle (seconds)
A	Operations with very low delay occurring with favorable progression and / or short cycle lengths.	≤ 10.0
B	Operations with low delay occurring with good progression and / or short cycle lengths.	10.1 to 20.0
C	Operations with average delays resulting from fair progression and / or longer cycle lengths. Individual cycle failures begin to appear.	20.1 to 35.0
D	Operations with longer delays due to a combination of unfavorable progression, long cycle lengths, and high volume-to-capacity (V / C) ratios. Many vehicles stop and individual cycle failures are noticeable.	35.1 to 55.0
E	Operations with high delay values indicating poor progression, long cycle lengths, and high V / C ratios. Individual cycle failures are frequent occurrences.	55.1 to 80.0
F	Operations with delays unacceptable to most drivers occurring due to over-saturation, poor progression, or very long cycle lengths.	> 80.0

Source: *Traffic Level of Service Analysis Guidelines*, VTA Congestion Management Program, June 2003; and *Highway Capacity Manual*, Transportation Research Board, 2000.

1.4.2 FREEWAY SEGMENTS

Freeway segments were evaluated using VTA’s analysis procedure, which is based on the density of the traffic flow using methods described in the 2000 HCM. Density is expressed in passenger cars per mile per lane. The Congestion Management Program ranges of densities for each freeway segment level of service designation are shown in **Table 1-3**.



TABLE 1-3: FREEWAY SEGMENT LEVEL OF SERVICE DEFINITIONS

Level of Service	Density (passenger cars per mile per lane)
A	≤ 11
B	11.1 to 18.0
C	18.1 to 26.0
D	26.1 to 46.0
E	46.1 to 58.0
F	> 58.0

Sources: *Traffic Level of Service Analysis Guidelines*, VTA Congestion Management Program, June 2003; *Highway Capacity Manual*, Transportation Research Board, 2000.

1.5 LEVEL OF SERVICE STANDARDS AND IMPACT CRITERIA

The determination of significance for Project impacts is based on applicable policies, regulations, goals, and guidelines defined by the City of Cupertino, City of Sunnyvale, Santa Clara County, and the VTA. The impact criteria presented below focuses on elements of the CEQA checklist pertaining to roadway system operations and its effects on users, including drivers, pedestrians, bicyclists, transit passengers, and first responders in emergency access vehicles.

1.5.1 SIGNALIZED INTERSECTIONS

Signalized intersection operations and impacts are evaluated based on the appropriate jurisdiction's LOS standards (i.e., minimum threshold for acceptable operations) as shown in **Table 1-4**.

TABLE 1-4: SIGNALIZED INTERSECTION LOS STANDARDS

Jurisdiction	Intersection LOS Standards
City of Cupertino	LOS D for all City controlled signalized intersections except at the Stevens Creek Boulevard/De Anza Boulevard intersection. The threshold for this intersection is LOS E+ (with no more than 60 seconds of weighted average control delay). The City of Cupertino also applies their LOS D standard to CMP intersections.
City of Sunnyvale	LOS D for all City controlled signalized intersections, except regionally significant roadways, which include El Camino Real and Lawrence Expressway (LOS E threshold).
Santa Clara County	LOS E for all Santa Clara County expressway intersections.
VTA Congestion Management Program (CMP)	LOS E for all CMP intersections.

Source: Fehr & Peers, 2015



City of Cupertino

Significant impacts at signalized City of Cupertino intersections would occur when the addition of Project traffic causes one of the following:

- Intersection operations to degrade from an acceptable level (LOS D or better) to an unacceptable level (LOS E or F); or
- Exacerbates unacceptable operations (LOS E or F) by increasing the critical delay by more than four seconds and increasing the volume-to-capacity (V/C) ratio by 0.01 or more; or
- An increase in the V/C ratio of 0.01 or more at an intersection with unacceptable operations (LOS E or F) when the change in critical delay is negative (i.e., decreases). This can occur if the critical movements change.

City of Sunnyvale

Significant impacts at signalized City of Sunnyvale intersections would occur when the addition of Project traffic causes one of the following:

- Intersection (except those on designated regionally significant roads) operations degrade from an acceptable level (LOS D or better) to an unacceptable level (LOS E or LOS F); or
- Operations for regionally significant designated intersections deteriorate from an acceptable level (LOS E or better) to an unacceptable level (LOS F);
- Exacerbates unacceptable operations by increasing the critical delay more than four seconds and increasing the volume-to-capacity (V/C) ratio by 0.01 or more; or
- An increase in the V/C ratio of 0.01 or more at an intersection with unacceptable operations when the change in critical delay is negative (i.e., decreases). This can occur if the critical movements change.

Santa Clara County and Congestion Management Program (CMP)

The LOS standard for Santa Clara County expressway and CMP intersections is LOS E. Traffic impacts at these intersections would occur when the addition of traffic associated with a Project causes:

- Intersection operations to deteriorate from an acceptable level (LOS E or better) to an unacceptable level (LOS F); or
- Exacerbates unacceptable operations by increasing the average critical delay more than four seconds and increasing the critical volume-to-capacity (V/C) ratio by 0.01 or more at an intersection operating at LOS F; or



- The V/C ratio increases by 0.01 or more at an intersection with unacceptable operations (LOS F) when the change in critical delay is negative (i.e., decreases). This can occur if the critical movements change.

1.5.2 FREEWAY SEGMENTS

Caltrans has authority over the State highway system including freeways, interchanges, and arterial State Routes. Caltrans operates and maintains the State Highways in Santa Clara. The *Guide for the Preparation of Traffic Impact Studies* (Caltrans, 2001) includes the information needed for Caltrans to review the impact on State highway facilities, including freeway segments. However, as the Congestion Management Agency, VTA is responsible for monitoring operations on Caltrans facilities within Santa Clara County.

Significant impacts on freeway segments in Santa Clara County are determined according to VTA criteria and would occur when the addition of Project traffic causes under Existing Conditions:

- Freeway segment operations to deteriorate from an acceptable level (LOS E or better) to an unacceptable level (LOS F); or
- An increase in traffic of more than one percent of the capacity of the segments that operate at LOS F.

1.6 REPORT ORGANIZATION

The remainder of this report is divided into the following chapters:

- **Chapter 1** describes the study area, analysis scenarios, analysis methods, level of service standards, and impact criteria.
- **Chapter 2** describes the existing transportation system near the project site and the current operating conditions of the key intersections and freeway segments.
- **Chapter 3** describes the project traffic estimates which includes trip generation, trip distribution, and trip assignment.
- **Chapter 4** describes Existing plus Project Conditions Project impacts on the transportation system.
- **Chapter 5** describes Background and Background plus Project Conditions.
- **Chapter 6** describes construction trip generation estimates.
- **Chapter 7** provides an assessment of site access, on-site circulation, multi-modal transportation, and parking.



2. EXISTING CONDITIONS

This chapter describes the existing conditions of the surrounding roadway facilities, pedestrian and bicycle facilities, and transit service. It also presents existing traffic volumes and operations for the study intersections and freeway segments with the results of the level of service calculations.

The Hamptons Apartment Complex is surrounded primarily by residential land uses of single-family neighborhoods to the west and south. Multi-family residential also exists in the area including the Ariso Apartments west of Wolfe Road. North and east of the project site is the Apple Campus 2 which is currently under construction.

2.1 EXISTING ROADWAY NETWORK

Interstate 280 (I-280) provides regional access to the project site. The following streets provide local access to the project site: Lawrence Expressway, Wolfe Road-Miller Avenue, Tantau Avenue, Homestead Road, Stevens Creek Boulevard, and Vallco Parkway. Descriptions of these roadways are presented below. **Figure 1-1** shows the locations of these facilities in relation to the project site.

I-280 is located immediately south of the project site and provides regional freeway access between the cities of San Francisco and San Jose. Near the project site, I-280 is a north-south freeway with three mixed-flow lanes and one high occupancy vehicle (HOV) lane in each direction. HOV lanes, also known as diamond or carpool lanes, restrict use to vehicles with two or more persons (carpool, vanpool, and buses) or motorcycles during the morning (5:00 am to 9:00 am) and evening (3:00 pm to 7:00 pm) commute periods. Auxiliary lanes, lanes running from a freeway entrance ramp to a subsequent freeway exit ramp that assist in weaving and merging movements, are provided along I-280 from Winchester Boulevard to SR 85, with the exception of the segment between Wolfe Road and De Anza Boulevard. An extended merge lane is provided for the Wolfe Road on-ramp to northbound I-280, and an extended deceleration lane is provided for the De Anza Boulevard off-ramp from northbound I-280. Access to/from I-280 is provided via its interchanges with De Anza Boulevard, Wolfe Road, Stevens Creek Boulevard, and Lawrence Expressway. Near the project site, I-280 has an average daily traffic (ADT) volume of approximately 158,000 vehicles.

Lawrence Expressway is a limited-access north-south facility operated by Santa Clara County that travels between State Route 237 near Moffett Field in the north and Saratoga Avenue/Quito Road at the border between the cities of San Jose and Saratoga to the south. It is a six-lane facility south of I-280. North of I-280, Lawrence Expressway is an eight-lane facility with the right-most lane in each direction restricted to HOVs during the commute hours. Lawrence Expressway provides local access to the site via the intersection at Stevens Creek Boulevard. Near the project site, the ADT on Lawrence Expressway is about 65,000 vehicles.



Wolfe Road is a four-to-six-lane north-south roadway. North of Stevens Creek Boulevard the roadway is designated as an arterial in the City of Cupertino General Plan; south of Stevens Creek Boulevard, it is designated as a major collector. It extends north to the City of Sunnyvale and south to the City of Saratoga. South of Stevens Creek Boulevard, the roadway is called Miller Avenue. Wolfe Road provides the project site with access to I-280 by a partial cloverleaf interchange approximately 0.15 miles south of the Pruneridge Avenue/Wolfe Road intersection and has an ADT of approximately 44,900 vehicles.

Tantau Avenue is a two-lane, north-south minor collector that extends from Bollinger Road in the south to Homestead Road in the north. North of Stevens Creek Boulevard, Tantau Avenue has an ADT of about 7,000 vehicles.

Homestead Road is a four-lane, east-west arterial that extends from Foothill Expressway in the west to Lafayette Street in the east (adjacent to Santa Clara University). Homestead Road has an ADT of approximately 21,000 vehicles.

Stevens Creek Boulevard is an east-west six-lane divided arterial that connects western Cupertino into downtown San Jose (via West San Carlos Street). Stevens Creek Boulevard provides access to SR 85, I-280 and Lawrence Expressway via interchanges. The roadway connects all of the north-south facilities described above. Near the project site, Stevens Creek Boulevard has an ADT of about 25,000 vehicles.

Vallco Parkway is a short (less than 0.5 mile) four-lane, east-west roadway that provides a connection between Wolfe Road and Tantau Avenue. Vallco Parkway has an approximate ADT of 4,000 vehicles. Entitled development projects, including Rose Bowl and Main Street, are located along Vallco Parkway.

2.2 PEDESTRIAN FACILITIES

Pedestrian facilities consist of sidewalks, crosswalks, and pedestrian signals. Pedestrian connectivity immediately surrounding the Project site is provided by a mostly complete network of sidewalks and crosswalks. Sidewalks are provided along the frontage of the project site along Wolfe Road and north of the project site. The sidewalks along Wolfe Road have park strips which act as an additional buffer between vehicles and pedestrians. Pedestrian signals and high visibility crosswalks are provided at the adjacent intersection on Wolfe Road and Pruneridge Avenue. Pedestrians are able to cross the street in both the north-south and east-west directions at this location. Pedestrian facilities within 1,000 are displayed in **Figure 2-1**.

Within approximately 1,000 feet of the project site, crosswalks and pedestrian signals are provided at the Wolfe Road intersections at Homestead Road, Apple Campus 2, Vallco Parkway, and Stevens Creek Boulevard. These intersections have pedestrian crosswalks for all four approaches. Pedestrian crosswalks and pedestrian signals are also present at the Wolfe Road and I-280 NB off-ramp and Wolfe Road and I-



280 SB off-ramp. Pedestrian crosswalks at the ramp locations only provide access in north-south direction. Crosswalks are not provided to cross Wolfe Road at these locations.

2.3 BICYCLE FACILITIES

Bikeway planning and design in California typically relies on guidelines and design standards established by California Department of Transportation (Caltrans) in the *Highway Design Manual* (Chapter 1000: Bikeway Planning and Design and other design documents). Bicycle facilities are comprised of paths (Class I), lanes (Class II), and routes (Class III), as described below and shown on the accompanying figures. Bicycle facilities within the immediate vicinity (within a 1/2-mile) of the project site are displayed on **Figure 2-2**.

- *Class I Bikeway (Bike Path)* provides a completely separate right-of-way and is designated for the exclusive use of bicycles and pedestrians with vehicle and pedestrian cross-flow minimized. In general, bike paths serve corridors not served by streets and highways or where sufficient right-of-way exists to allow such facilities to be constructed away from the influence of parallel streets and vehicle conflicts.



- *Class II Bikeways (Bike Lanes)* are lanes for bicyclists generally adjacent to the outer vehicle travel lanes. These lanes have special lane markings, pavement legends, and signage. Bicycle lanes are generally five (5) feet wide. Adjacent vehicle parking and vehicle/pedestrian cross-flow are permitted.

Provides a striped lane for one-way bike travel on a street or highway.

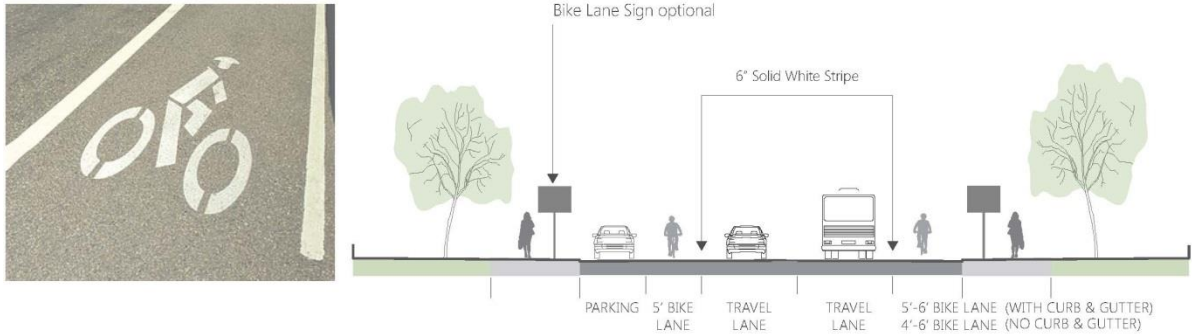

- Class III Bikeway (Bike Route) are designated by signs or pavement markings for shared use with pedestrians or motor vehicles, but have no separated bike right-of-way or lane striping. Bike routes serve either to: a) provide continuity to other bicycle facilities, or b) designate preferred routes through high demand corridors.

With Optional Sharrow Pavement Marking
Provides for shared use with motor vehicle traffic.

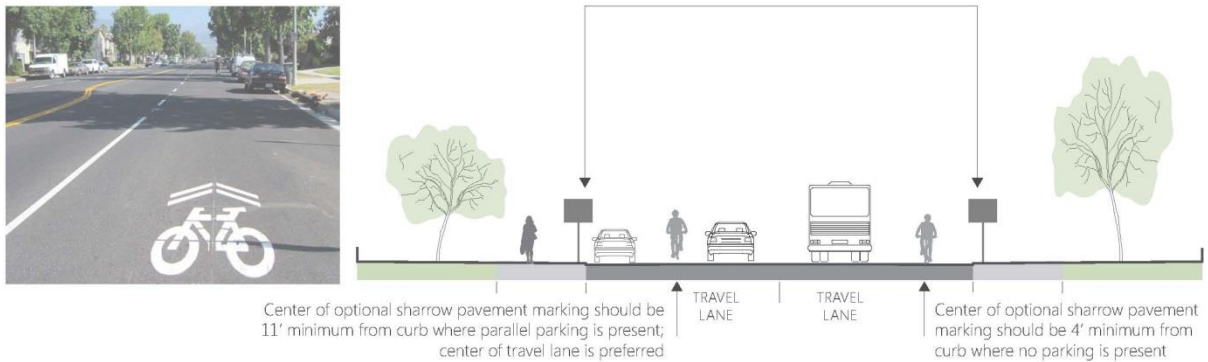

- Class IV Bikeways (Cycletracks or Protected Bike Lanes) provide a right-of-way designated exclusively for bicycle travel within a roadway and which are protected from other vehicle traffic with devices, including, but not limited to, grade separation, flexible posts, inflexible physical barriers, or parked cars

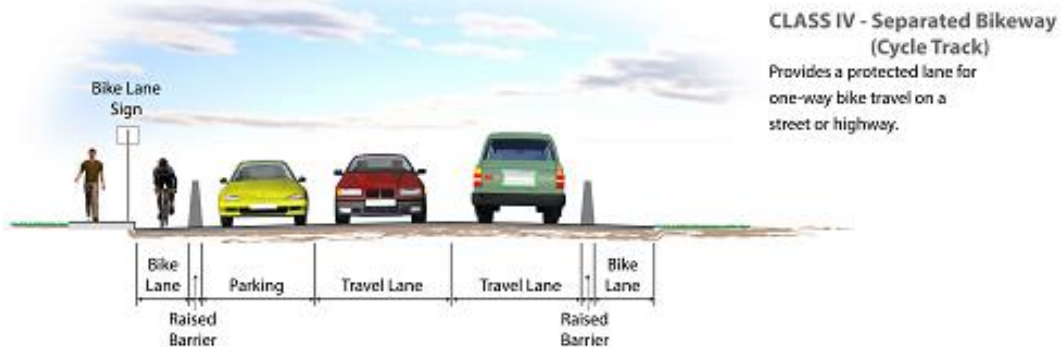

The *VTA Bicycle Technical Guidelines* (December 2007) recommends that Caltrans standards regarding bicycle facility dimension be used as a minimum and provides supplemental information and guidance on when and how to better accommodate the many types of bicyclists.

Near the project site, bicycle lanes (Class II) are provided on Wolfe Road, Homestead Road, Tantau Avenue, Vallco Parkway, and Stevens Creek Boulevard. There is a discontinuity in the Class II facility along Wolfe Road at the I-280 overcrossing. South of Stevens Creek Boulevard, Tantau Avenue transitions from a Class II to a Class III bicycle facility.

Class III bike route exists Tantau Avenue south of Stevens Creek Boulevard to Barnhart Avenue. Miller Avenue is also a Class III facility that transitions to a Class II facility with bike lanes south of Calle De Barcelona. Bicycle facilities comprising bicycle lanes (Class II) and bicycle routes (Class III) connect the project site to the Lawrence Caltrain station.

In 2011, the City of Cupertino adopted its Bicycle Transportation Plan, which illustrates Cupertino's current bicycle network, identifies gaps in the network, and proposes improvement projects to address the identified gaps. VTA adopted the Santa Clara Countywide Bicycle Plan (CBP). The CBP guides the development of major bicycle facilities in the County by identifying Cross County Bicycle Corridors and other bicycle projects of countywide or intercity significance. Several of the Cross County Bicycle Corridors travel through the study area, including routes along Vallco Parkway, Stevens Creek Boulevard, Wolfe Road/Miller Avenue, and Tantau Avenue.



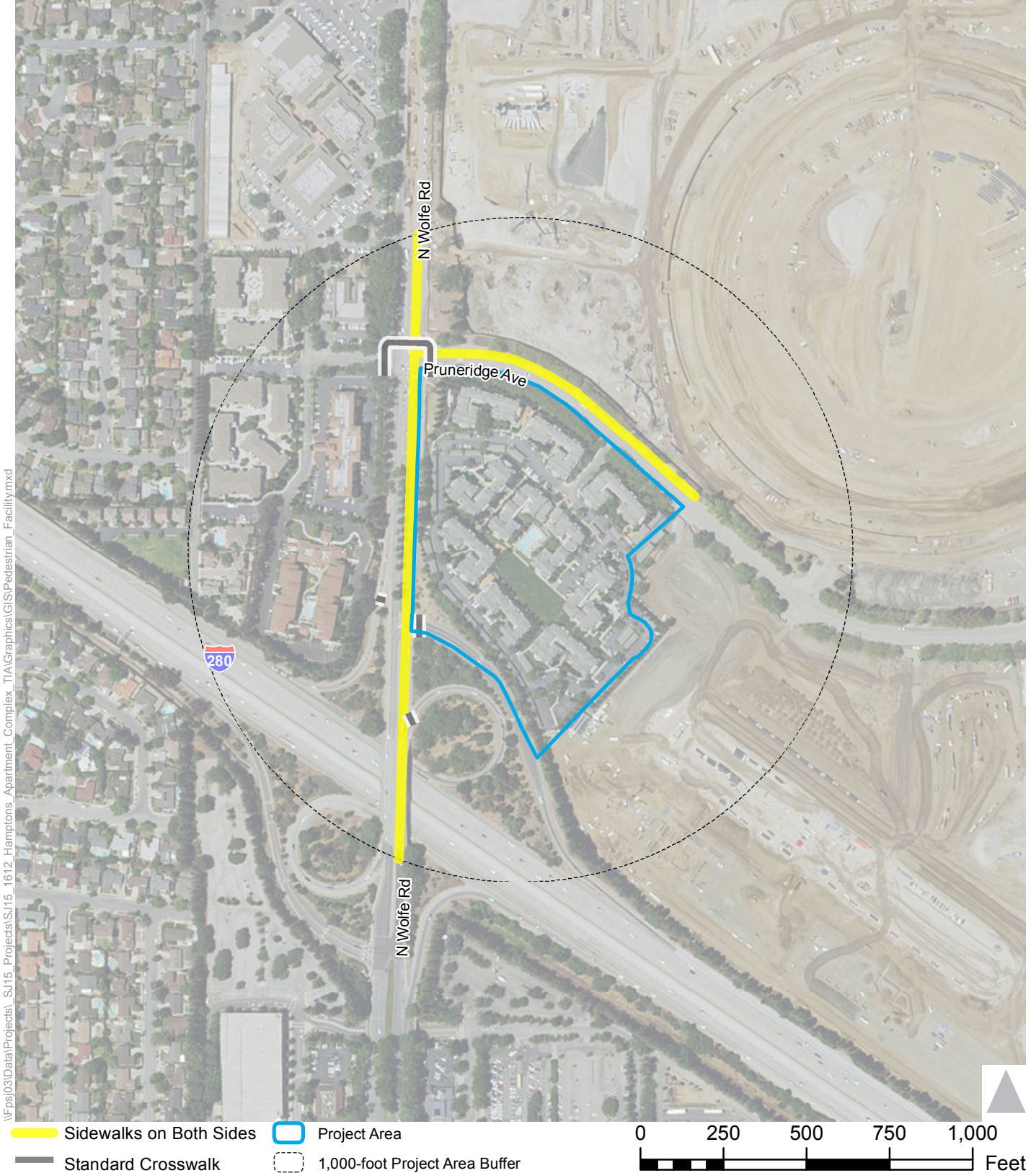

\\Fps03\Data\Projects\ SJ15_Prosjcts\SJ15_1612_Hampton_Apartment_Complex_TIA\Graphics\GIS\Pedestrian_Facility.mxd



Figure 2-1
 Pedestrian Facilities

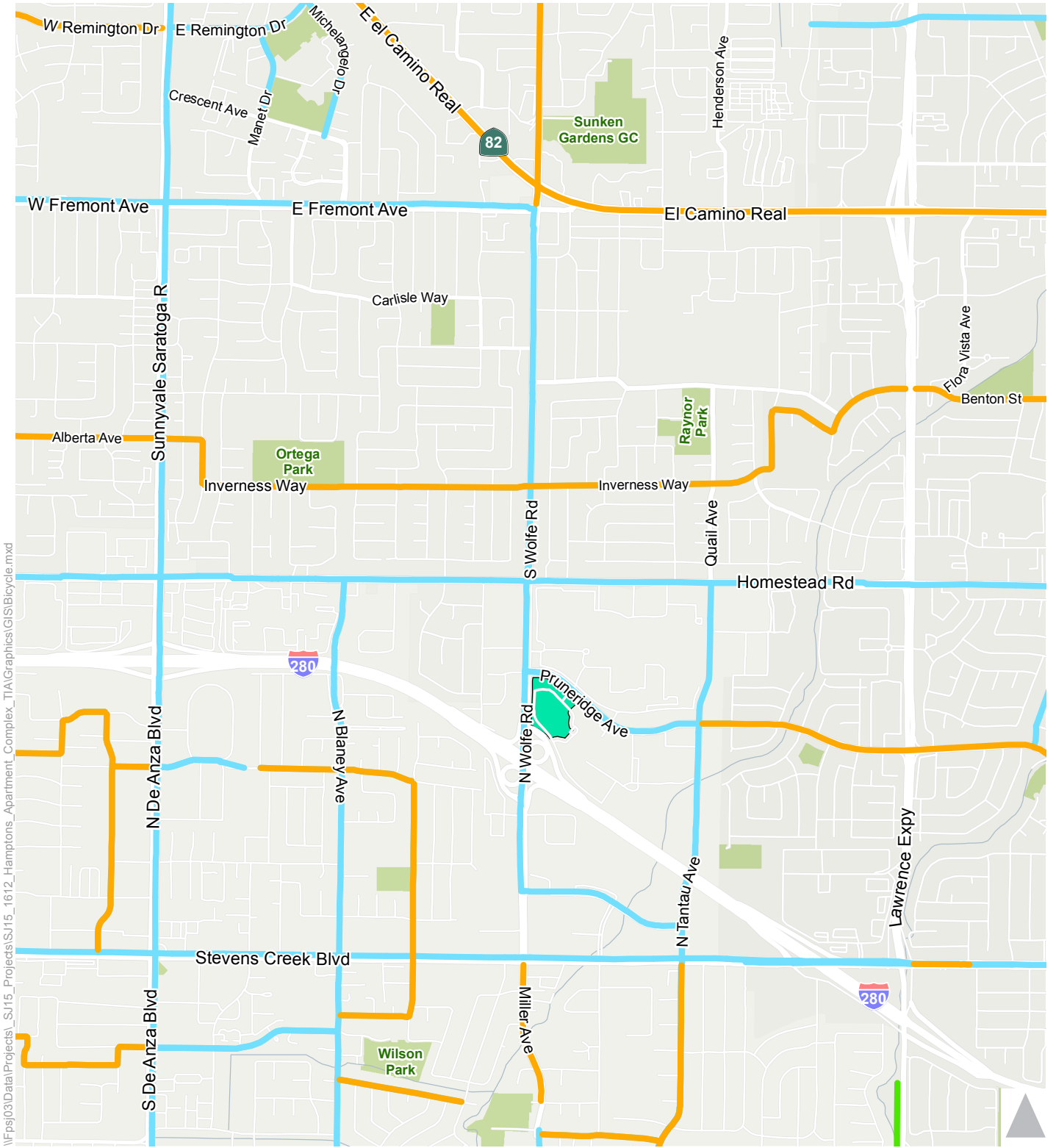

- Project Site
- Class I Bicycle Path
- Class II Bicycle Lane
- Class III Bicycle Route



Figure 2-2
Bicycle Facilities

2.4 TRANSIT SERVICE

This section summarizes local and regional transit connectivity in the Study Area, including bus, light rail, commuter rail, and public and private shuttles. The greater San Francisco Bay Area is served by an extensive public transit network of rail, buses, and ferries. Many of these transit providers offer service in the Study Area, providing regional transit mobility to employees, residents, and visitors in Cupertino. **Figure 2-3** illustrates the existing transit facilities and routes in the study area which include shuttles, buses, light rail, and heavy rail services. Nearby transit services are described below and **Table 2-1** summarizes the destinations, closest stop to the project site, hours/days of operation, and service frequencies for transit services within a 2,000-foot walking distance.

2.4.1 VTA BUS SERVICE

Bus Route 26 provides service between Sunnyvale/Lockheed Martin Transit Center and the Eastridge Transit Center. Route 26 follows major arterials and travels through Sunnyvale, Cupertino, San Jose, and Campbell on Fair Oaks Avenue, Wolfe Road, Campbell Avenue, and Tully Road. Bus stops for Route 26 are provided immediately north of the project site along Wolfe Road.

Bus Route 81 provides service between San Jose State University and Vallco via the Santa Clara Transit Center and Downtown San Jose. This route operates on Stevens Creek Boulevard, Benton Street, West San Carlos Street, and San Fernando Street with nearby stops at Tantau Avenue and Pruneridge Avenue.

Bus Route 101 is an express bus route that operates on I-280, Stevens Creek Boulevard, and Lawrence Expressway; it connects a Park & Ride lot at the Camden Avenue interchange along SR 85 to Palo Alto. This route passes through the Winchester Transit Center and has a bus stop south of the project site at Wolfe Road/Vallco Mall which provides connections to Routes 26, 23, and 323.

Bus Route 182 is an express bus route that operates on I-280, Wolfe Road, Vallco Parkway, and Stevens Creek Boulevard; it connects the Park & Ride lot at El Camino Real and Page Mill Road in Palo Alto with the IBM Santa Teresa Facility at Bailey Avenue. One Route 182 run departs Palo Alto in the morning. In the evening, one Route 182 run travels northbound. Route 182 has stops at the Vallco shopping plaza.

2.4.2 COMMUTER RAIL SERVICE

Caltrain is a commuter heavy rail service that runs from downtown San Francisco (4th and King Streets) to downtown San Jose (Diridon Station), with a limited number of commute period trains running farther south to Gilroy. During commute periods, Caltrain offers express service ("Baby Bullet") between downtown San Jose and San Francisco, which allows the trip between San Francisco and San Jose to be made in one hour. This service stops at a limited number of stations, including the Mountain View and Sunnyvale stations. Currently, Baby Bullet service is provided both in the northbound and southbound



direction during the morning and evening commute periods at the Mountain View Caltrain station. Baby Bullet trains serve the Sunnyvale Caltrain station in the northbound direction during the morning peak and in the southbound direction during the evening peak.

The nearest station to the project site is the Lawrence Station and is approximately three miles from the project site. During the weekdays, service in the northbound direction begins at 4:40 AM and ends at 10:40 PM. In the southbound direction, service at this station begins at 6:14 AM and ends at 1:20 AM. During the weekends, northbound service begins at 7:10 AM and ends at 10:40 PM. Southbound service begins at 9:40 AM and ends at 1:26 AM. For passengers arriving by bicycle, there are 18 bike racks and 24 bicycle lockers. Vehicle parking at this location includes 122 parking spaces.

TABLE 2-1: EXISTING TRANSIT SERVICE

Route	From	To	Distance to Nearest Stop ¹	Weekdays			Saturdays	
				Average Peak Load Factor ²	Operating Hours ⁴	Peak Headway ³	Operating Hours ⁴	Peak Headway ³
VTA Bus Service								
26	Sunnyvale / Lockheed Martin Transit Center	Eastridge Transit Center	0.15	0.27	5:52 a – 11:31 p	30	6:46 a – 10:40 p	30
81	San Jose State University	Vallco	0.10	0.07	6:17 a – 8:19 p	30	9:30 a – 4:30 p	60
101	Camden & Highway 85	Palo Alto	0.55	0.23	6:51 a – 7:48 a 4:52 p – 5:55 p	2 NB Runs – AM 2 SB Runs – PM	No Service	
182	Palo Alto	IBM/Bailey Avenue	0.60	0.07	7:27 a – 8:34 a 5:05 p – 6:14 p	1 SB Run – AM 1 NB Run – PM	No Service	
Commuter Rail Service								
Caltrain	San Francisco	San Jose Diridon	3.00	N/A	4:40 a – 1:20 a	30 (local) / 15 (express)	7:10 a – 1:26 a	60

Notes:

1. Approximate distance in miles from nearest stop to Hamptons Apartment Complex driveway.
2. Average peak load factor is the ratio of the average peak number of on-board passengers aboard during the peak period to supply of seats.
3. Headways are defined as the time interval between two transit vehicles traveling in the same direction over the same route.
4. Operating hours consider earliest and latest stop at each bus lines closest stop to the Hamptons Apartment Complex.
5. AM = morning commuter period; PM = evening commute period

Source: VTA, December 2015.



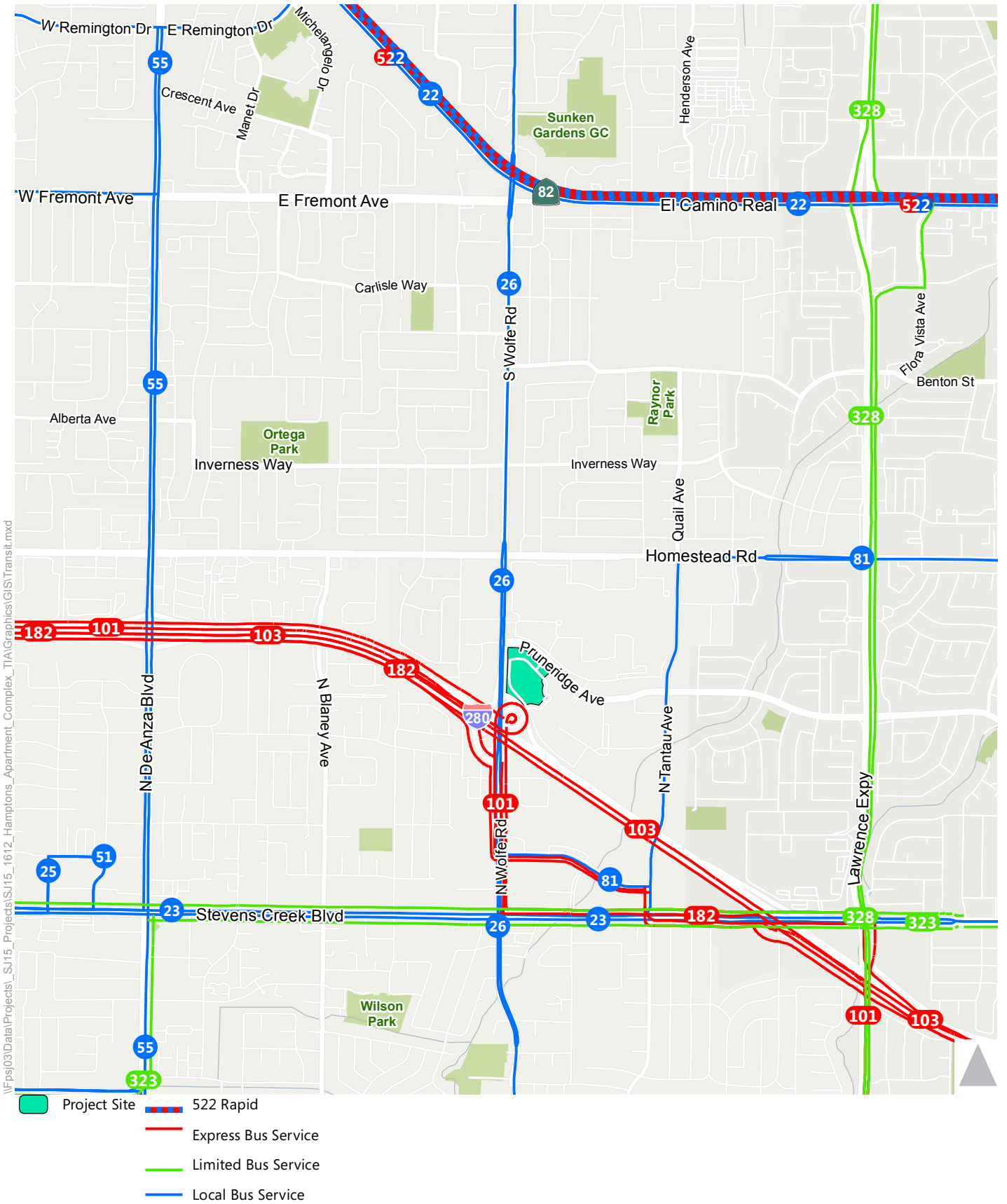

\\Fps03\Data\Projects\SJ15_1612_Hampton_Apartment_Complex_TIA\Graphics\GIS\Transit.mxd



Figure 2-3
Existing Transit

2.5 EXISTING INTERSECTION VOLUMES AND LANE CONFIGURATIONS

The existing operations of the study intersections were evaluated with the highest one-hour volumes during the weekday morning and evening peak periods. In general, AM and PM peak period intersection turning movement counts were conducted between May 2014 and April 2015 (counts prior to April 2015 were provided by the City of Sunnyvale). **Figure 2-4** presents the existing AM and PM peak-hour turning movement volumes, lane configurations, and traffic control devices at the study intersections.

2.6 EXISTING INTERSECTION LEVEL OF SERVICE

Existing lane configurations, signal timings, and peak-hour turning movement volumes were used to calculate the levels of service for the key intersections during each peak hour. The results of the LOS analysis using the TRAFFIX software program for Existing Conditions are presented in **Table 2-2**. **Appendix B** contains the corresponding calculation sheets. The results indicate that all study intersections operate at acceptable service levels (LOS D or better for City intersections and LOS E or better for regionally significant and CMP intersections) during the AM and PM peak hours.

TABLE 2-2: EXISTING INTERSECTION LEVEL OF SERVICE RESULTS

ID #	Intersection	Jurisdiction / CMP ¹	LOS Threshold	Peak Hour ²	Delay ³	LOS ⁴
1	Wolfe Road / El Camino Real	Sunnyvale (CMP)	E	AM PM	35.4 38.4	D D
2	Wolfe Road / Fremont Avenue	Sunnyvale	D	AM PM	34.0 36.4	C D
3	Wolfe Road / Marion Way	Sunnyvale	D	AM PM	15.0 21.5	B C
4	Wolfe Road / Inverness Avenue	Sunnyvale	D	AM PM	17.9 17.8	B B
5	Wolfe Road / Homestead Road	Cupertino	D	AM PM	34.0 36.4	C D
6	Wolfe Road / Apple Campus 2	Cupertino	D	AM PM	0.8 ⁶ 0.9 ⁶	A A
7	Wolfe Road / Pruneridge Avenue	Cupertino	D	AM PM	19.7 19.6	B B
8	Wolfe Road / I-280 NB Ramps	Cupertino (CMP)	D	AM PM	20.8 22.7	C C
9	Wolfe Road / I-280 SB Ramps	Cupertino (CMP)	D	AM PM	17.9 12.0	B B



TABLE 2-2: EXISTING INTERSECTION LEVEL OF SERVICE RESULTS

ID #	Intersection	Jurisdiction / CMP ¹	LOS Threshold	Peak Hour ²	Delay ³	LOS ⁴
10	Wolfe Road / Vallco Parkway	Cupertino	D	AM PM	21.7 28.5	C C
11	Wolfe Road / Stevens Creek Boulevard	Cupertino (CMP)	D	AM PM	42.0 42.8	D D
12	De Anza Boulevard / Stevens Creek Boulevard	Cupertino (CMP)	E+	AM PM	33.2 44.6	C D
13	Tantau Avenue / Homestead Road	Cupertino	D	AM PM	28.5 36.8	C D
14	Tantau Avenue / Vallco Parkway	Cupertino	D	AM PM	18.6 24.0	B C
15	Tantau Avenue / Stevens Creek Boulevard	Cupertino	D	AM PM	39.7 38.2	D D
16	Lawrence Expressway / Homestead Road	Santa Clara County (CMP)	E	AM PM	43.3 48.3	D D

Notes:

1. Intersection jurisdiction and identification of CMP (Congestion Management Program) intersections.
2. AM = morning peak hour, PM = evening peak hour.
3. Whole intersection weighted average control delay expressed in seconds per vehicle calculated using methods described in the 2000 *Highway Capacity Manual*, with adjusted saturation flow rates to reflect Santa Clara County Conditions for signalized intersections.
4. LOS = Level of Service. LOS calculations conducted using the TRAFFIX analysis software packages, which apply the methods described in the 2000 *Highway Capacity Manual*.
5. All of the study intersections are signalized.
6. Because Apple Campus 2 is still under construction, vehicle turning movements do not occur to/from the Apple Campus 2 driveway. Therefore, intersection delay at this location is negligible.

Source: Fehr & Peers, 2015.



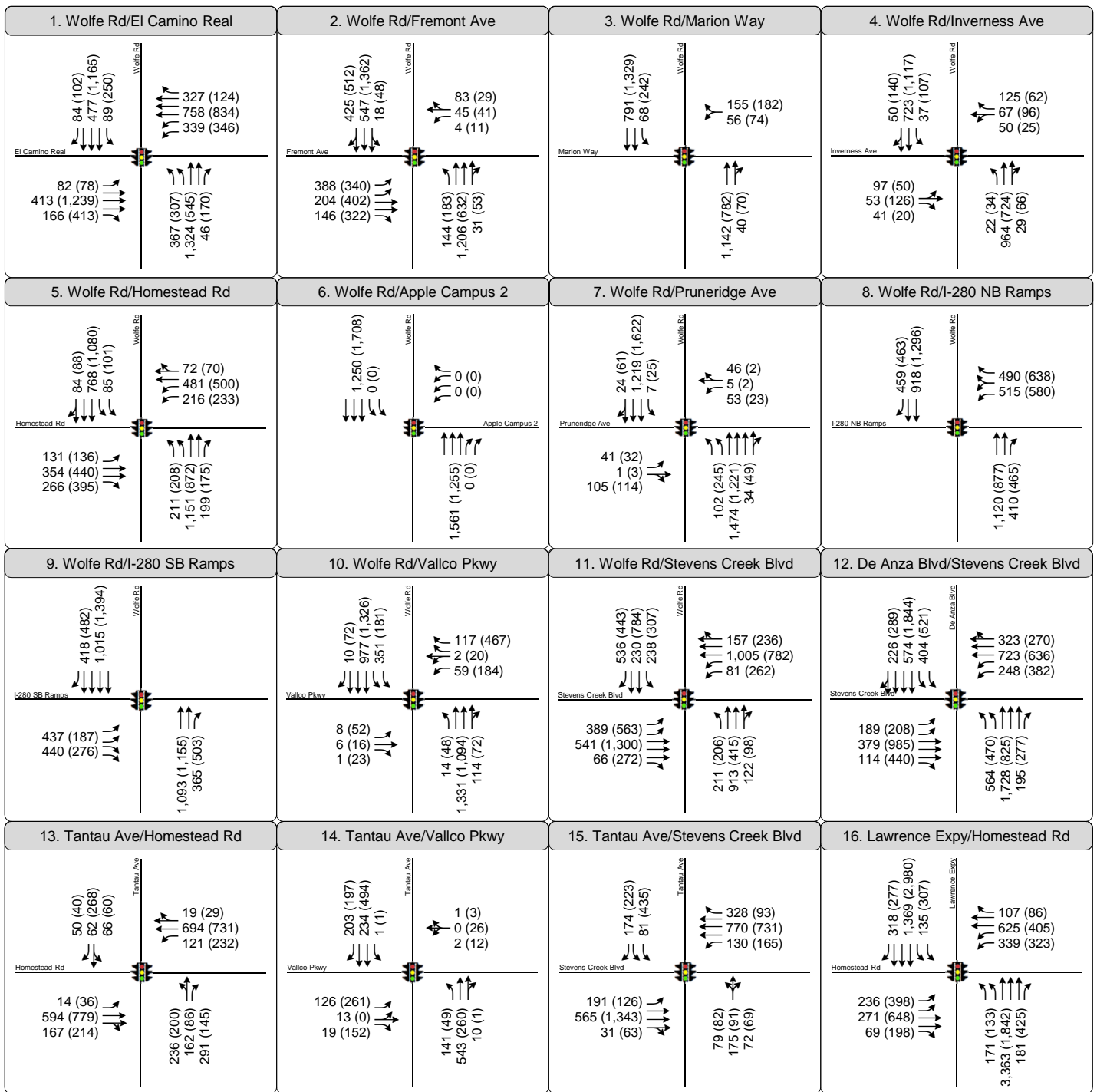

Figure 2-4

Peak Hour Traffic Volumes and Lane Configurations - Existing Conditions



2.7 EXISTING FREEWAY SEGMENT LEVEL OF SERVICE

For freeway segments, Existing Conditions are defined as existing volumes and geometry as stated in the 2014 VTA Monitoring and Conformance Report. **Table 2-3** contains the existing freeway segment levels of service for the mixed-flow and HOV lanes based on the segment densities. During the AM peak hour, all of the mixed-flow freeway segments exceed LOS E in the northbound direction. During the PM peak hour, all of the mixed-flow freeway segments exceed the VTA's LOS E standard in the southbound direction.

Additionally, the only HOV lane segment exceeding VTA's LOS E standard is Saratoga Avenue to Lawrence Expressway in northbound direction during the AM peak hour.

TABLE 2-3: EXISTING FREEWAY (I-280) LEVEL OF SERVICE RESULTS

Freeway Segment	Peak Hour	Number of Lanes		Density		LOS	
		Mixed	HOV	Mixed	HOV	Mixed	HOV
Southbound							
SR 85 to De Anza Boulevard	AM	3	1	24	9	C	A
	PM			103	19	F	E
De Anza Boulevard to Wolfe Road	AM	3	1	36	10	D	A
	PM			77	30	F	E
Wolfe Road to Lawrence Expressway	AM	3	1	35	16	D	B
	PM			81	19	F	E
Lawrence Expressway to Saratoga Avenue	AM	3	1	37	10	D	A
	PM			85	37	F	D
Northbound							
Saratoga Avenue to Lawrence Expressway	AM	3	1	89	78	F	F
	PM			37	15	D	B
Lawrence Expressway to Wolfe Road	AM	3	1	81	46	F	D
	PM			23	10	C	A
Wolfe Road to De Anza Boulevard	AM	3	1	62	57	F	E
	PM			25	7	C	A
De Anza Boulevard to SR 85	AM	3	1	73	45	F	D
	PM			23	7	C	A

Notes: **Bold** font indicates unacceptable operations based on VTA's LOS E Standard.

Source: 2014 VTA Monitoring and Conformance Report, 2015.



3. PROJECT TRAFFIC ESTIMATES

The amount of traffic added to the roadway system by the proposed development is estimated using a three-step process: (1) trip generation, (2) trip distribution, and (3) trip assignment. The first step estimates the amount of traffic added to the roadway network. The second estimates the direction of travel to and from the project site. The new trips are assigned to specific street segments and intersection turning movements during the third step. The results of the process for the Project are described in the following sections.

3.1 TRIP GENERATION

As part of the Apple Campus 2 TIA (Fehr & Peers, May 31, 2013), driveway counts were collected at the main driveway to the Hamptons Apartment Complex in November 2011. Trip generation rates were developed by dividing the count results by the number of occupied units. These Hamptons-specific trip generation rates along with the Institute of Transportation Engineers (ITE) rates published in *Trip Generation Manual* (9th Edition) for Apartments (ITE Land Use Code 210) are summarized in **Table 3-1**.

TABLE 3-1: TRIP GENERATION RATE COMPARISON

Rate Source	Rates					
	AM Peak Hour			PM Peak Hour		
	In	Out	Total	In	Out	Total
Hamptons Driveway Count ¹	0.11	0.36	0.47	0.22	0.09	0.31
ITE (Land Use Code 210) – Average Rate	0.10	0.41	0.51	0.40	0.22	0.62
ITE (Land Use Code 210) – Fitted Curve Rate	0.10	0.40	0.50	0.39	0.21	0.60

Notes:

1. Hampton Driveway Counts collected November 2011 showed 160 AM peak hour trips (38 inbound and 122 outbound) and 105 PM peak hour trips (74 inbound and 31 outbound) for 342 existing apartment units.

Source: ITE *Trip Generation Manual* (9th Edition) and Fehr & Peers, December 2015.

As shown in **Table 3-1**, the Hamptons-specific trip generation rates for the AM peak hour are slightly lower but similar to ITE rates. The Hampton-specific PM peak hour rates, however, are approximately half of ITE's rates. Residents of the Hamptons may also travel outside of the typical PM peak period due to shifts in work hours. Based on this comparison and to present a reasonably conservative analysis, ITE rates were applied for the Hamptons Apartment TIA, rather than the Hamptons-specific rates.

3.1.1 TRIP REDUCTIONS

Reductions were applied to the project trip generation to account for residents who would walk to and from the adjacent Apple Campus 2. (The Hamptons Apartment Complex is immediately southwest of the new campus and less than a quarter of a mile away.) There is no known agreement between the



Hamptons and Apple regarding employee occupancy of the new residential development, but it is assumed that the Hamptons will be an attractive housing option due its close proximity to Apple's campus. A 10 percent reduction in AM and PM peak hour trips was included to take into account trips by Apple employees living in the Hamptons Apartments made by walking instead of driving.

3.1.2 TRIP ESTIMATES

As outlined above, trip generation estimates were determined using ITE's rates for apartments (ITE Land Use Code 210) for the proposed 942 unit apartment complex with a 10 percent reduction to account for Apple employees walking to Apple Campus 2. Trip generation estimates for the existing apartment uses were determined using data from driveway counts conducted at the Hamptons Apartment Complex in November 2011 as part of the Apple Campus 2 TIA. The existing trip estimates were subtracted from the project trips to develop net new project trips. The Hamptons vehicle trip generation estimates are presented in **Table 3-2**.

TABLE 3-2: HAMPTONS VEHICLE TRIP GENERATION ESTIMATES

Item	Size	Units	Weekday	AM Peak Hour			PM Peak Hour		
				In	Out	Total	In	Out	Total
Apartments	942	du	6,264	96	384	480	380	204	584
10% Trip Reduction			<u>-626</u>	<u>-10</u>	<u>-38</u>	<u>-48</u>	<u>-38</u>	<u>-20</u>	<u>-58</u>
Net Project Trips (with 10% Reduction) = (A)			5,638	86	346	432	342	184	526
Existing Trips = (B)			<u>-1,618</u>	<u>-38</u>	<u>-122</u>	<u>-160</u>	<u>-74</u>	<u>-31</u>	<u>-105</u>
Net New Trips = (A) – (B)			4,020	48	224	272	268	153	421

Source: ITE *Trip Generation Manual*, 9th edition, 2012; Fehr & Peers, December 2015

3.2 TRIP DISTRIBUTION AND TRIP ASSIGNMENT

The distribution of the traffic generated by the Project onto the roadway system was based on the locations of complementary land uses, prevailing travel patterns, surrounding population densities, and recent TIAs completed in the area. Input from the City of Cupertino staff was used to refine the trip distribution patterns. The trip distribution pattern is shown in **Figure 3-1**.

Project trips were assigned to the roadway network based on the trip distribution patterns discussed above. **Figure 3-2** shows the AM and PM peak hour project trips assigned to each turning movement at the study intersections.



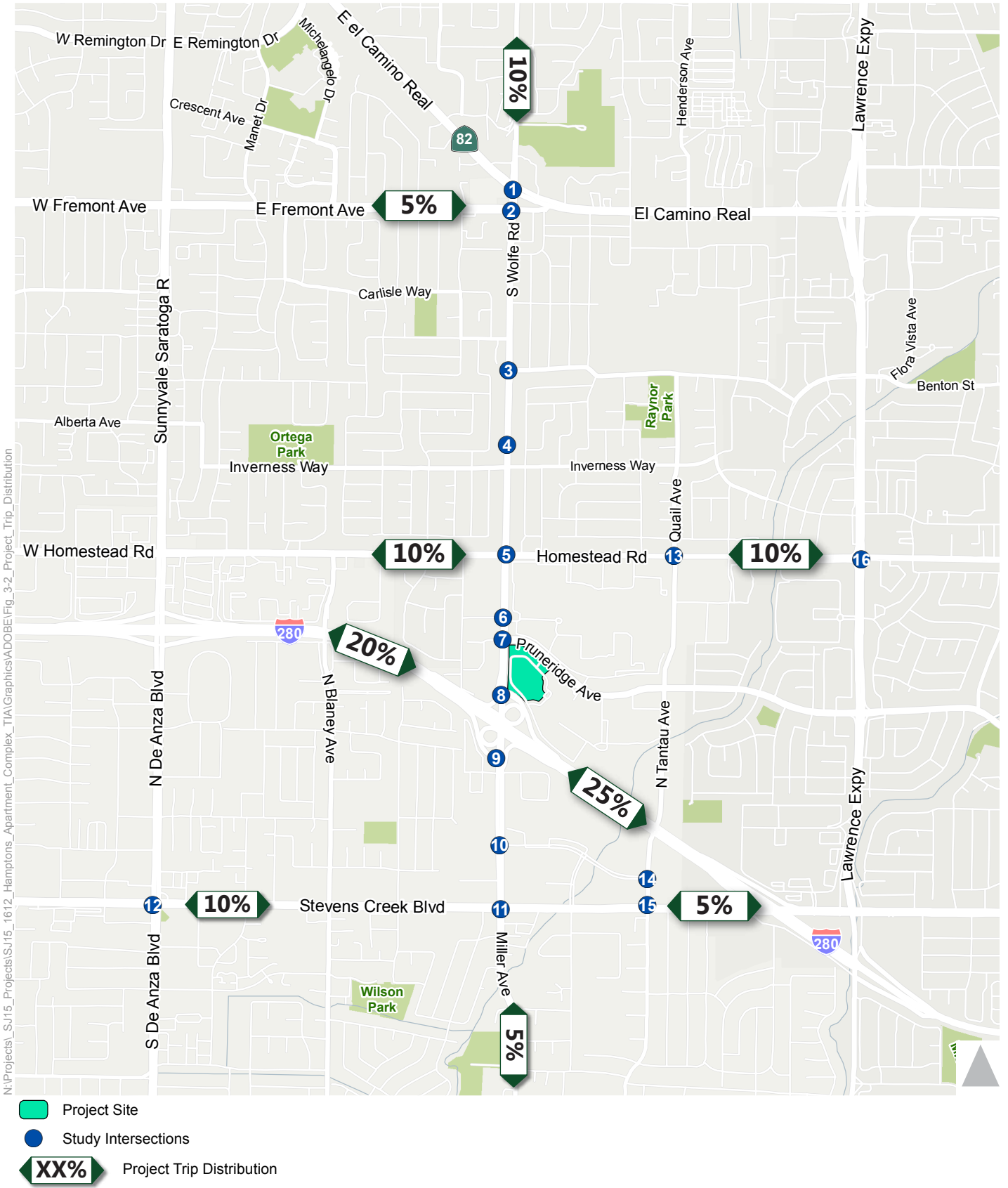

Figure 3-1

Trip Distribution



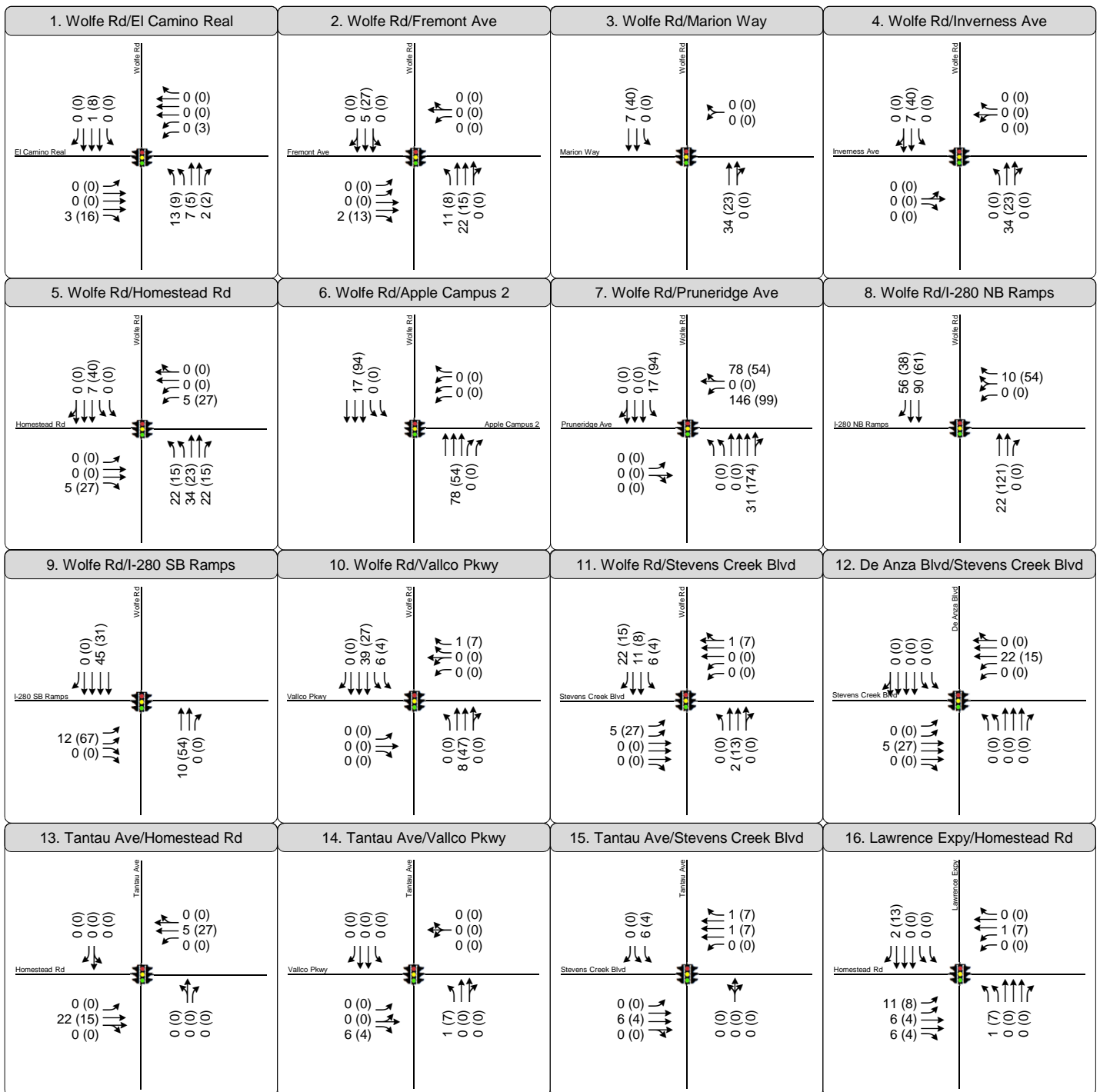

Figure 3-2
Peak Hour Traffic Volumes
and Lane Configurations -
Project Trips



4. EXISTING PLUS PROJECT CONDITIONS

This section presents the operations of the surrounding transportation system under Existing plus Project Conditions. Existing plus Project Conditions are defined as Existing Conditions with build-out of the Project. The peak hour vehicle trip estimates to and from the project site are based on the trip estimates discussed in **Chapter 3: Project Traffic Estimates**. Potential impacts to the roadway system under this scenario are identified by comparing the level of service results under Existing plus Project Conditions to those under Existing Conditions without the Project.

4.1 EXISTING PLUS PROJECT VOLUMES

Trips generated from the proposed project were added to the existing traffic to develop traffic volumes for the Existing plus Project Conditions. The resulting volumes are shown on **Figure 4-1**.

4.2 EXISTING PLUS PROJECT INTERSECTION LEVEL OF SERVICE

Intersection levels of service were calculated with the new traffic added by the Project to evaluate the operating conditions of the intersections and identify potential impacts to the roadway system. The results of the intersection level of service calculations for Existing plus Project Conditions are presented in **Table 4-1**. **Appendix B** contains the corresponding calculation sheets. The results for Existing Conditions are included for comparison purpose, along with the projected increases in critical delay and critical volume-to-capacity (V/C) ratios. Critical delay represents the delay associated with the critical movements of the intersection, or the movements that require the most “green time” and have the greatest effect on overall intersection operations. The changes in critical delay and critical V/C ratio between Existing and Existing plus Project Conditions are used to identify significant impacts.

The results of the LOS calculations indicate that all study intersection operate at acceptable service levels (LOS D or better for signalized City intersection and LOS E or better for regionally significant and unsignalized intersections) during the AM and PM peak hours under Existing plus Project Conditions.



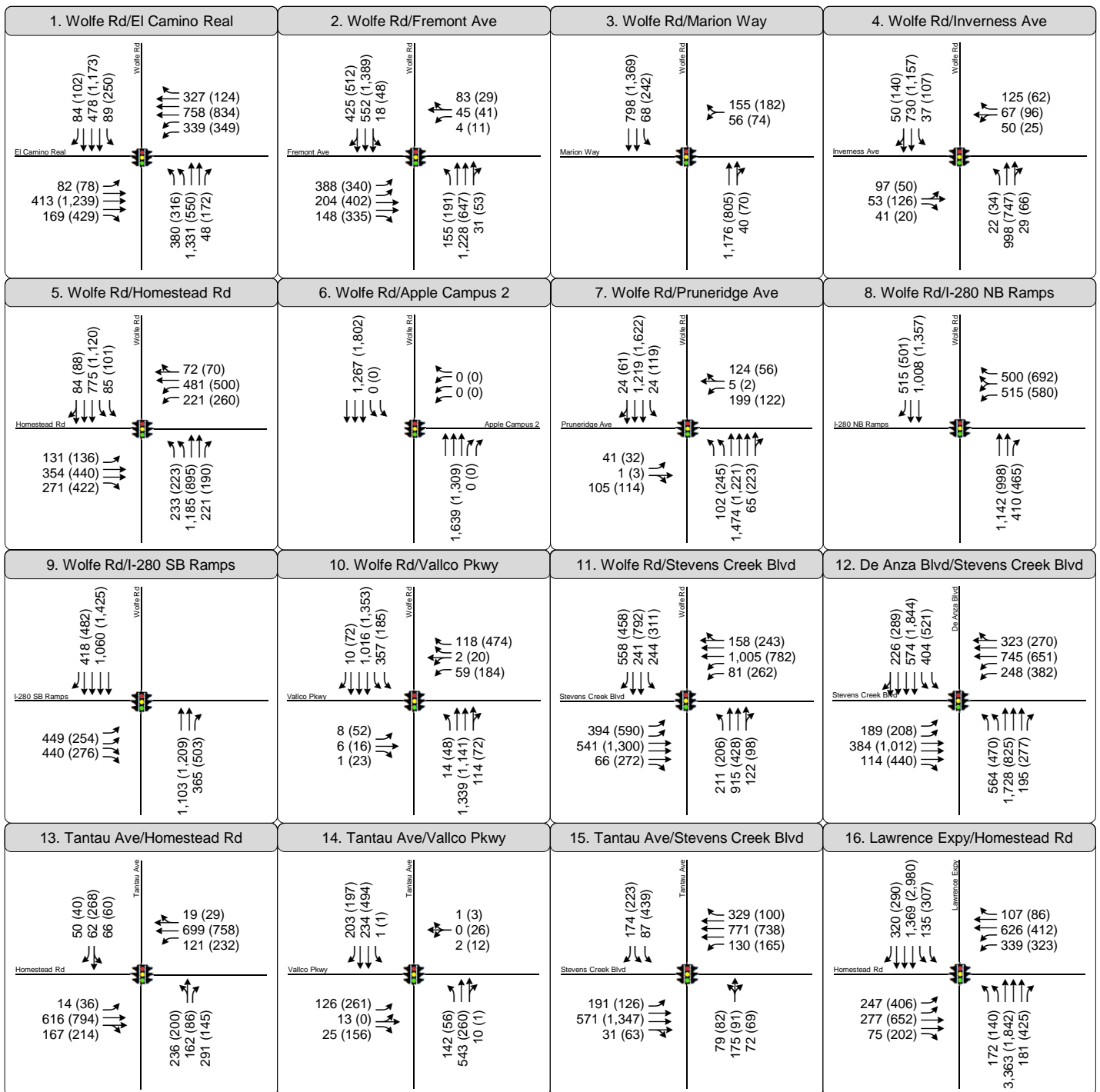

Figure 4-1

Peak Hour Traffic Volumes and Lane Configurations - Existing plus Project Conditions



TABLE 4-1: EXISTING PLUS PROJECT INTERSECTION LEVEL OF SERVICE RESULTS

ID	Intersection	Jurisdiction / CMP	LOS Threshold ¹	Peak Hour ²	Existing		Existing plus Project			
					Delay ³	LOS ⁴	Delay ³	LOS ⁴	Δ in Crit. V/C ⁵	Δ in Crit. Delay ⁶
1	Wolfe Road / El Camino Real	Sunnyvale (CMP)	E	AM PM	35.4 38.4	D D	35.4 38.6	D D	0.002 0.006	0.0 0.3
2	Wolfe Road / Fremont Avenue	Sunnyvale	D	AM PM	34.0 36.4	C D	34.2 36.7	C D	0.006 0.008	0.0 0.2
3	Wolfe Road / Marion Way	Sunnyvale	D	AM PM	15.0 21.5	B C	14.9 21.4	B C	0.010 0.007	-0.2 -0.1
4	Wolfe Road / Inverness Avenue	Sunnyvale	D	AM PM	17.9 17.8	B B	17.7 17.6	B B	0.010 0.012	-0.2 -0.1
5	Wolfe Road / Homestead Road	Cupertino	D	AM PM	34.0 36.4	C D	34.2 37.4	C D	0.010 0.033	0.0 1.3
6	Wolfe Road / Apple Campus 2	Cupertino	D	AM PM	0.8 ⁸ 0.9 ⁸	A A	0.8 ⁸ 0.9 ⁸	A A	0.015 0.018	0.0 0.0
7	Wolfe Road / Pruneridge Avenue	Cupertino	D	AM PM	19.7 19.6	B B	27.8 24.5	C C	0.093 0.075	8.1 4.1
8	Wolfe Road / I-280 NB Ramps	Cupertino (CMP)	D	AM PM	20.8 22.7	C C	20.9 23.3	C C	0.007 0.036	0.1 0.8
9	Wolfe Road / I-280 SB Ramps	Cupertino (CMP)	D	AM PM	17.9 12	B B	17.8 12.4	B B	0.007 0.015	0.2 -0.3
10	Wolfe Road / Vallco Parkway	Cupertino	D	AM PM	21.7 28.5	C C	21.6 28.5	C C	0.004 0.008	0.2 0.0
11	Wolfe Road / Stevens Creek Boulevard	Cupertino (CMP)	D	AM PM	42.0 42.8	D D	42.2 43.1	D D	0.006 0.013	0.3 0.6
12	De Anza Boulevard / Stevens Creek Boulevard	Cupertino (CMP)	E+	AM PM	33.2 44.6	C D	33.4 44.7	C D	0.004 0.000	0.3 0.0
13	Tantau Avenue / Homestead Road	Cupertino	D	AM PM	28.5 36.8	C D	28.5 37	C D	0.007 0.005	0.1 0.4
14	Tantau Avenue / Vallco Parkway	Cupertino	D	AM PM	18.6 24.0	B C	18.7 24.4	B C	0.000 0.007	0.0 0.6
15	Tantau Avenue / Stevens Creek Boulevard	Cupertino	D	AM PM	39.7 38.2	D D	39.7 38.1	D D	0.000 0.002	0.0 0.1
16	Lawrence Expressway / Homestead Road	Santa Clara County (CMP)	E	AM PM	43.3 48.3	D D	43.9 48.9	D D	0.004 0.004	1.5 0.5

Notes:

1. LOS Threshold is the lowest acceptable LOS (the threshold between acceptable and unacceptable level of service).
2. AM = morning peak hour, PM = evening peak hour.
3. Whole intersection weighted average control delay expressed in seconds per vehicle calculated using methods described in the 2000 *Highway Capacity Manual*, with adjusted saturation flow rates to reflect Santa Clara County Conditions for signalized intersections.



4. LOS = Level of Service. LOS calculations conducted using the TRAFFIX analysis software packages, which apply the methods described in the 2000 *Highway Capacity Manual*.
5. Change in critical volume to capacity ratio between Existing and Existing plus Project Conditions
6. Change in average critical movement delay between Existing and Existing plus Project Conditions.
7. All of the study intersections are signalized.
8. Because Apple Campus 2 is still under construction, vehicle turning movements do not occur to/from the Apple Campus 2 driveway. Therefore, intersection delay at this location is negligible.

Source: Fehr & Peers, 2015.



4.3 EXISTING PLUS PROJECT INTERSECTION IMPACTS AND MITIGATION MEASURES

This section of the report evaluates the intersection LOS results presented in **Table 4-1** against the impact criteria discussed in Chapter 2.5 and presents mitigation measures for identified impacts. Based on the identified appropriate impact criteria, the Project has **less-than-significant** impact at all study intersections under the Existing plus Project scenario and no mitigation measures are required.

4.4 EXISTING PLUS PROJECT FREEWAY SEGMENT LEVEL OF SERVICE

Freeway segments of I-280 were analyzed during the AM and PM peak hours by calculating the amount of project traffic projected to be added to these freeway segments. To be conservative, no project trips were assigned to the HOV lanes. **Table 4-2** presents the estimated number of trips added to the freeway segments under Existing plus Project Conditions and the estimated densities and service levels.

4.5 EXISTING PLUS PROJECT FREEWAY SEGMENT IMPACTS AND MITIGATION MEASURES

Traffic impacts on CMP freeway segments would occur when the addition of project traffic causes the freeway segment operations to deteriorate from an acceptable level (LOS E or better) under Existing Conditions to an unacceptable level (LOS F) or an increase in traffic of more than one percent of the capacity of the segments that operate at LOS F under Existing Conditions.

As shown in **Table 4-2**, the Project would not add trips greater than one percent of the freeway segment capacity to the freeway study segments during the AM and PM peak hours. Therefore, the Project would have a **less-than-significant** freeway impact at the identified freeway study segments under Existing plus Project Conditions and no mitigation measures are proposed.



TABLE 4-2: EXISTING FREEWAY (I-280) LEVEL OF SERVICE RESULTS

I-280 Freeway Segment	Capacity ¹	Peak Hour ²	Existing Conditions		Existing plus Project Conditions			
			Density ³	LOS ⁴	Trips ⁵	Density ³	LOS ⁴	% Impact ⁶
Southbound								
SR 85 to De Anza Boulevard	6,900	AM PM	24 103	C F	12 67	24 105	C F	<0.01 <0.01
De Anza Boulevard to Wolfe Road	6,900	AM PM	36 77	D F	12 67	36 78	D F	<0.01 <0.01
Wolfe Road to Lawrence Expressway	6,900	AM PM	35 81	D F	45 31	35 82	D F	<0.01 <0.01
Lawrence Expressway to Saratoga Avenue	6,900	AM PM	37 85	D F	45 31	37 86	D F	<0.01 <0.01
Northbound								
Saratoga Avenue to Lawrence Expressway	6,900	AM PM	89 37	F D	10 54	89 37	F D	<0.01 <0.01
Lawrence Expressway to Wolfe Road	6,900	AM PM	81 23	F C	10 54	81 23	F C	<0.01 <0.01
Wolfe Road to De Anza Boulevard	6,900	AM PM	62 25	F C	56 38	63 26	F C	<0.01 <0.01
De Anza Boulevard to SR 85	6,900	AM PM	73 23	F C	56 38	74 23	F C	<0.01 <0.01

Notes: **Bold text** indicates intersection operates at unacceptable level of service.

1. Measured in vehicles per hour per lane.
2. AM = morning peak hour, PM = evening peak hour.
3. Measured in passenger cars per mile per lane.
4. LOS = level of service
5. Project trips added to individual freeway segments.
6. Percent Contribution determined by dividing the number of project trips by the freeway segment's capacity.

Source: VTA Monitoring and Conformance Report, 2014; Fehr & Peers, 2015



5. BACKGROUND CONDITIONS

This chapter presents the results of the level of service calculations under Background Conditions with and without the Project. Traffic volumes for Background No Project Conditions comprise of existing volumes plus traffic generated by “approved but not yet built” and “not occupied” developments to account for local growth in the study area. Background plus Project Conditions are defined as Background Conditions plus traffic generated by the Project.

5.1 BACKGROUND TRAFFIC VOLUMES

Vehicle trips from “approved but not yet built” and “not occupied” development projects in the study area were added to existing volumes. Trip generation estimates from these development projects that would add traffic to the study intersections were obtained from their respective traffic reports or estimated using trip generated rates published in the Institute of Transportation Engineers *Trip Generation Manual* (9th Edition). The trips for each of the background projects were then assigned to the roadway network based on the relative locations of complementary land uses, as well as existing and estimated future travel patterns. Background traffic volumes are presented in **Figure 5-1**.

5.2 BACKGROUND PLUS PROJECT TRAFFIC VOLUMES

Trips generated from the Project were added to the Background traffic projects to develop traffic volumes for Background plus Project Conditions. The resulting volumes are shown on **Figure 5-2**.

5.3 BACKGROUND INTERSECTION LEVEL OF SERVICE

LOS calculations were conducted to evaluate signalized intersection operations under Background plus Project Conditions. The LOS analysis results are summarized in **Table 5-1**. The corresponding LOS calculation sheets are included in **Appendix B**.

5.4 BACKGROUND INTERSECTION IMPACTS AND MITIGATION MEASURES

The results presented in **Table 5-1** show that three study intersections would operate unacceptably during the AM peak hour or both peak hours under Background Conditions and Background plus Project Conditions. However, based on the impact criteria identified in Chapter 1.5, the Project would have a **less-than-significant** impact. Therefore, no mitigation measures are required.



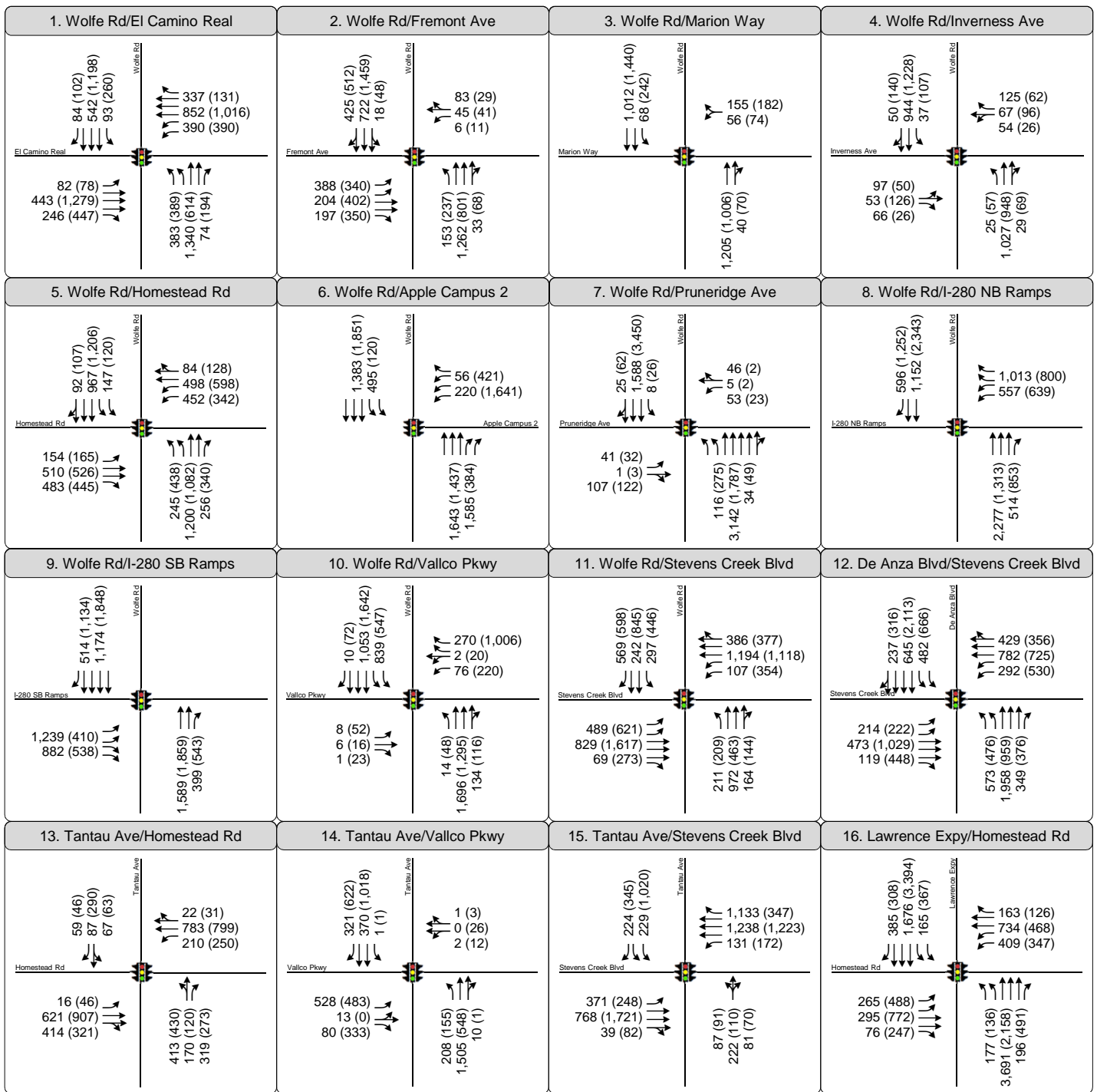

Figure 5-1

Peak Hour Traffic Volumes and Lane Configurations - Background Conditions



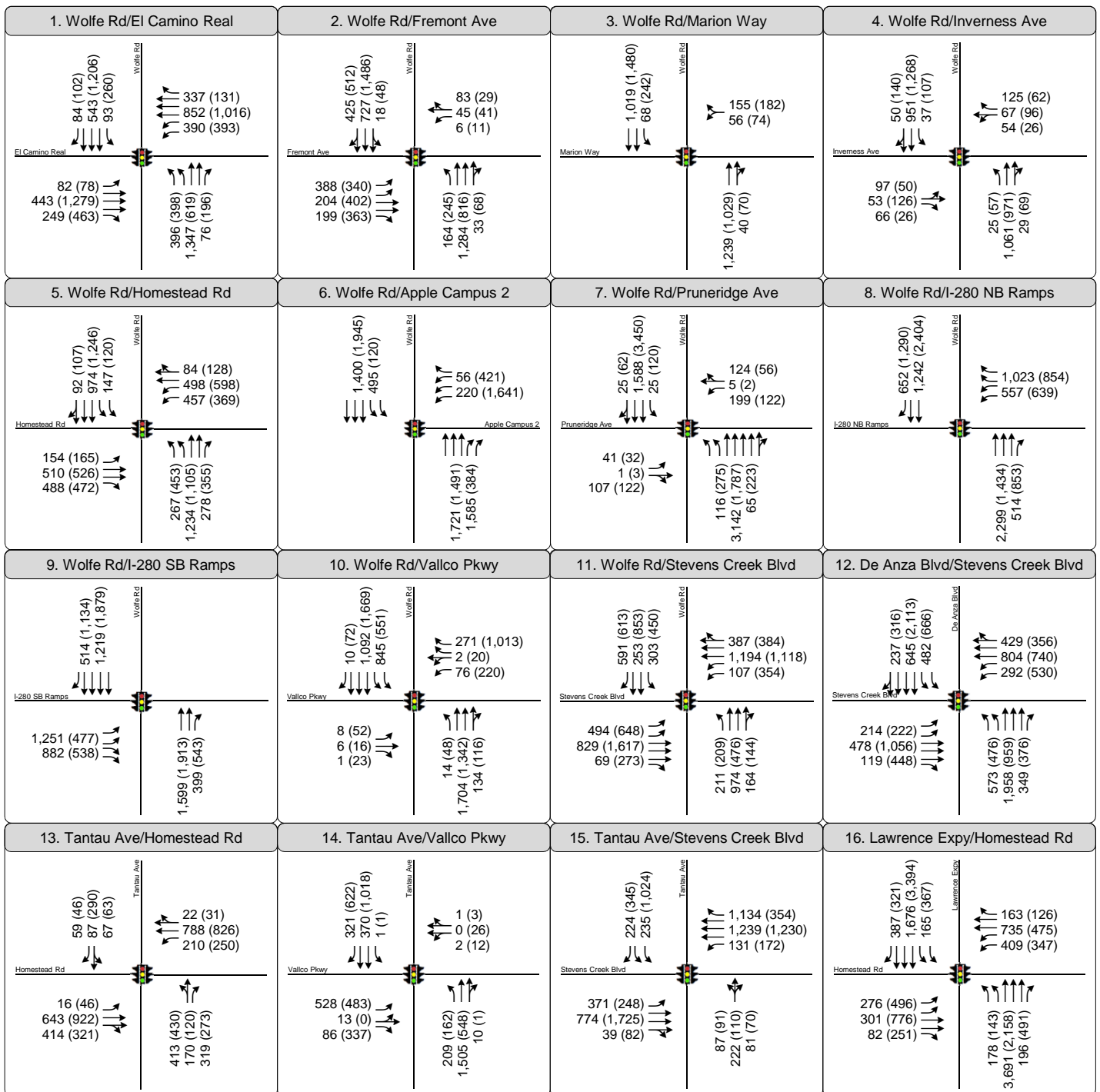

Figure 5-2
Peak Hour Traffic Volumes
and Lane Configurations -
Background plus Project Conditions



TABLE 5-1: BACKGROUND PLUS PROJECT INTERSECTION LEVEL OF SERVICE RESULTS

ID	Intersection	Jurisdiction / CMP	LOS Threshold ¹	Peak Hour ²	Background		Background plus Project			
					Delay ³	LOS ⁴	Delay ³	LOS ⁴	Δ in Crit. V/C ⁵	Δ in Crit. Delay ⁶
1	Wolfe Road / El Camino Real	Sunnyvale (CMP)	E	AM PM	35.7 40.0	D D	35.7 40.1	D D	0.002 0.006	0.0 0.3
2	Wolfe Road / Fremont Avenue	Sunnyvale	D	AM PM	35.0 38.5	C D	35.2 38.9	D D	0.006 0.008	0.1 0.3
3	Wolfe Road / Marion Way	Sunnyvale	D	AM PM	14.3 20.7	B C	14.2 20.7	B C	0.010 0.007	-0.2 -0.1
4	Wolfe Road / Inverness Avenue	Sunnyvale	D	AM PM	24.5 24.5	C C	24.2 24.3	C C	0.010 0.012	-0.2 -0.1
5	Wolfe Road / Homestead Road	Cupertino	D	AM PM	31.5 31.3	C C	31.5 31.6	C C	0.007 0.013	-0.3 0.2
6	Wolfe Road / Apple Campus 2	Cupertino	D	AM PM	15.6 28.2	B C	15.6 28.5	B C	0.000 0.018	0.0 0.5
7	Wolfe Road / Pruneridge Avenue	Cupertino	D	AM PM	14.3 25.3	B C	22.4 29.9	C C	0.107 0.063	8.7 5.9
8	Wolfe Road / I-280 NB Ramps	Cupertino (CMP)	D	AM PM	26.0 29.7	C C	26.3 33.7	C C	0.008 0.036	0.3 7.1
9	Wolfe Road / I-280 SB Ramps	Cupertino (CMP)	D	AM PM	29.6 17.0	C B	29.8 17.5	C B	0.007 0.015	0.6 0.1
10	Wolfe Road / Vallco Parkway	Cupertino	D	AM PM	28.5 29.2	C C	28.5 29.3	C C	0.004 0.012	0.2 0.3
11	Wolfe Road / Stevens Creek Boulevard	Cupertino (CMP)	D	AM PM	48.3 51.4	D D	48.9 52.8	D D	0.006 0.016	0.8 2.6
12	De Anza Boulevard / Stevens Creek Boulevard	Cupertino (CMP)	E+	AM PM	37.7 54.1	D D	37.8 54.2	D D	0.000 0.000	0.0 0.0
13	Tantau Avenue / Homestead Road	Cupertino	D	AM PM	39.4 75.6	D E	40.2 76.4	D E	0.007 0.005	1.5 1.7
14	Tantau Avenue / Vallco Parkway	Cupertino	D	AM PM	27.5 29.7	C C	27.5 30.1	C C	0.000 0.007	0.0 0.8
15	Tantau Avenue / Stevens Creek Boulevard	Cupertino	D	AM PM	82.8 58.3	F E	83.0 58.7	F E	0.001 0.002	0.3 0.6
16	Lawrence Expressway / Homestead Road	Santa Clara County (CMP)	E	AM PM	110.7 83.4	F F	110.7 86.1	F F	0.002 -0.033	-0.1 1.6

Notes: **Bold text** indicates intersection operates at unacceptable level of service.

1. LOS Threshold is the lowest acceptable LOS (the threshold between acceptable and unacceptable level of service).
2. AM = morning peak hour, PM = evening peak hour.
3. Whole intersection weighted average control delay expressed in seconds per vehicle calculated using methods described in the 2000 *Highway Capacity Manual*, with adjusted saturation flow rates to reflect Santa Clara County Conditions for signalized intersections.



4. LOS = Level of Service. LOS calculations conducted using the TRAFFIX analysis software packages, which apply the methods described in the 2000 *Highway Capacity Manual*.
5. Change in critical volume to capacity ratio between Existing and Existing plus Project Conditions
6. Change in average critical movement delay between Existing and Existing plus Project Conditions.
7. All of the study intersections are signalized.

Source: Fehr & Peers, 2015.



6. CONSTRUCTION TRIP GENERATION ESTIMATES

During construction, the Project will generate changes to the existing transportation conditions. New traffic will be generated by construction employees and construction activities. Based on the construction schedule provided by the applicant, the busiest construction period is expected to be from December 2017 to July 2018. The construction activities occurring this period include dry wall and framing. **Table 6-1** presents the construction traffic trip generation which includes trips generated by general activity, construction employees and haul trucks.

Trip generation assumes an average of 4 daily trips per employee (1 trip to work, 1 trip to lunch or a meeting, 1 trip from lunch or a meeting, and 1 trip home). General activity employees include the project manager, superintendent, field engineer, and project secretary. Trip generation for construction workers are presented for the busiest construction period which is during the dry wall and framing portion. It is estimated that a maximum of 600 employees will be on site during this activity. These construction workers however will be shuttled from an off-site location. The analysis below assumes that each of the shuttles to the project site will have at least six construction workers which equates to 100 daily trips. Ten haul trucks were also estimated during the AM and PM peak hour (5 trucks in and 5 trucks out). Total construction trip generation estimates include 236 weekday trips, 64 trips during the AM peak hour (59 inbound and 5 outbound) and 64 trips during the PM peak hour (64 inbound and 5 outbound).

TABLE 6-1: CONSTRUCTION TRAFFIC TRIP GENERATION ESTIMATES

Activity	Daily	AM Total	AM In	AM Out	PM Total	PM In	PM Out
General Activity	16	4	4	0	4	0	4
Construction Worker	100	50	50	0	50	0	50
Haul Trucks	120	10	5	5	10	5	5
Total	236	64	59	5	64	5	59

Source: Irvine Company, 2015; Fehr & Peers, 2015



7. SITE ACCESS, ON-SITE CIRCULATION, MULTI-MODAL TRANSPORTATION, AND PARKING ASSESSMENT

This chapter of the report discusses transportation impacts related to accessing and navigating the Project site and impacts to pedestrian, bicyclist, and transit. Topics discussed include vehicular site access and on-site circulation, pedestrian and bicycle site access and circulation, and transit vehicle delay and site access.

7.1 VEHICLE ACCESS AND CIRCULATION REVIEW

The site plan for the proposed Project is presented in **Figure 1-2**. The site plan indicates the location of the project driveways and the internal circulation system for automobile, pedestrian, and bicycle traffic. One vehicular access in and out of the project site will be from Pruneridge Avenue. Motorists will have two lanes to access the parking structure located in the center of the complex; one is designated for residents and the other for visitors. Exit lanes are provided adjacent to the entrance lanes and are located to the east of the Pruneridge Avenue driveway. In the case of a stalled vehicle, residents should be allowed to access the parking garage using the designated visitor's lane.

Vehicle circulation in the parking structure will consist of ramps that allow for residents/visitors to access all levels of the garage. Emergency vehicle access for the project perimeters will be provided by a dual use road. This road is currently expected to accommodate emergency vehicles like fire trucks but will also permit use for moving trucks and garbage trucks. Loading zone and garbage pick-up zone locations however will be located off-road which allows emergency vehicles to have complete access.

7.2 PEDESTRIAN ACCESS AND CIRCULATION

Pedestrian access to the Project site is provided by a mostly complete network of sidewalks and crosswalks. Sidewalks are provided along the frontage of the project site along Wolfe Road and north of the project site allowing pedestrians to enter the apartment complex from the west and the north. The sidewalks along Wolfe Road have park strips which act as an additional buffer between vehicles and pedestrians. Pedestrian signals and high visibility crosswalks are provided at the adjacent intersection on allowing pedestrian travel to and from the project site in both the north-south and east-west directions.

7.3 BICYCLE ACCESS AND CIRCULATION

Bicycle access to the Hamptons Apartments is accommodated by bicycle lanes (Class II) on surround roadways such as Wolfe Road, Homestead Road, Tantau Avenue, Vallco Parkway, and Stevens Creek Boulevard. A discontinuity in the Class II facility does exist along Wolfe Road at the I-280 Ramps. Bicyclists will need to travel with motor vehicles for a short distance when approaching the I-280 overcrossing.



7.4 TRANSIT EVALUATION

This section discusses transit vehicle delay and transit access within the study area.

7.4.1 TRANSIT SITE ACCESS

Transit stops are available immediately north of the project site. VTA bus route 26 for both the northbound and southbound direction stops less than 0.15 miles north of the Project. Pedestrians can access this transit route using sidewalks and crosswalks from the Hamptons Apartments Apartment. Sidewalk gaps are not an issue when accessing this transit stop from the Project.

7.4.2 TRANSIT VEHICLE CAPACITY

Transit routes near the project site have low peak load factors. Average peak load factors for transit routes near the project site range from 0.07 to 0.25, which indicate that the seats on these transit routes are only about 25 percent or less occupied. Because of the limited amount of transit stops available in the area, it is unlikely that the Project will generate transit demand that would exceed to the transit vehicle capacity.

7.4.3 TRANSIT VEHICLE DELAY (FOR INFORMATIONAL PURPOSES)

Transit vehicles operating in the project vicinity could incur additional delay due to increased traffic congestion. The primary corridors near the Project site are Wolfe Road, Stevens Creek Boulevard, and Vallco Parkway. The difference between the No Project and Plus Project through movement delays along these primary corridors were used to determine the potential added transit vehicle delay. The analysis results are shown in **Table 7-1**.

TABLE 7-1: TRANSIT VEHICLE DELAY

Route		Peak Hour	Projected Additional Delay (sec)			
			Existing plus Project		Background plus Project	
			NB / EB	SB / WB	NB / EB	SB / WB
26	Sunnyvale to Eastridge Transit Center	AM	4.8	9.2	6.9	9.3
		PM	1.1	13.0	0.4	13.9
81	San Jose State University to Vallco	AM	0.5	0.4	0.3	0.9
		PM	0.3	0.6	3.0	1.7
101	Camden/Highway 85 to Palo Alto	AM	0.4	-0.4	1.9	0.2
		PM	-0.1	-0.6	3.4	1.2
182	Palo Alto to IBM/Bailey Avenue	AM	-0.1	0.1	1.1	-0.2
		PM	0.1	-0.3	0.7	3.2

Source: Fehr & Peers, 2015



7.4.4 TRANSIT IMPACTS

Transit impacts are considered significant if the proposed Project:

- Conflicts with existing or planned transit facilities
- Generates potential transit trips in excess of available capacity
- Does not provide adequate facilities for pedestrians and bicyclists to access transit routes and stops

Based on these criteria, the Project would not have a significant impact on transit service and would not require any mitigation.

7.5 PARKING ASSESSMENT

The City of Cupertino has vehicle and bicycle requirements for residential developments.

7.5.1 VEHICLE PARKING

Per the City of Cupertino requirements, high density residential apartments are required to provide two parking spaces per dwelling unit. These parking spaces must have a stall dimension of 9.5 feet by 20 feet. The Hamptons Apartment Complex proposes a total of 942 dwelling units, which would equate to a parking supply requirement of 1,884 vehicle parking spaces based on City code. However, the Irvine Company proposes to provide 1,716 vehicle parking spaces, which results in a parking supply rate of approximately 1.8 parking spaces per dwelling unit.

The ITE Parking Generation 4th Edition shows weekday average peak-period parking demand for low/mid-rise apartments to be 1.23 vehicle spaces per dwelling unit for suburban locations. Typical engineering practice for residential parking is to provide 10 to 15 percent more parking than demand to account for turn-over and to avoid vehicles circulating for parking. With a 10 to 15 percent increase, the ITE Parking Generation would suggest a parking ratio of 1.35-1.42 spaces per dwelling unit.

The Irvine Company also has several properties in Northern California with a parking ratio of 1.8 spaces per dwelling unit. They have found that the 1.8 spaces/unit parking ratio to be adequate and often times resulting in more parking spaces than required.

In addition, the high percentage of one bedroom and studio units (68 percent/639 units), the new bike hub, the high-level of pedestrian connectivity, and increased use of rideshare companies like Uber and Lyft. For the reasons stated above, a parking ratio of 1.8 vehicle spaces per dwelling unit can be justified for this site.



7.5.2 BICYCLE PARKING

The City of Cupertino provides bicycle parking requirements for residential developments. High density apartments are required to provide 0.4 bicycle storage spaces per dwelling unit. Two types of bicycle parking facility are Class I and Class II storage facilities. Class I facilities protect the entire bicycle from theft, vandalism, and inclement weather and are appropriate for long-term storage. Examples include bike lockers, rooms with key access, guarded parking areas, and valet/check-in parking. Class II parking facilities include bicycle racks to which the frame and at least one wheel can be secured with a user-provided lock.

Based on the requirement discussed above, the Hamptons Apartment Complex is required to supply 377 parking spaces. As part of the redevelopment project, the Hamptons Apartment Complex proposes to supply 377 Class I bicycle parking spaces.



APPENDIX A: EXISTING TRAFFIC COUNTS



Traffic Data Service

Campbell, CA
 (408) 377-2988
 tdsbay@cs.com

File Name : 4PM FINAL
 Site Code : 00000004
 Start Date : 1/26/2012
 Page No : 1

Groups Printed- Vehicles

Start Time	WOLFE RD Southbound					INVERNESS WAY Westbound					WOLFE RD Northbound					INVERNESS WAY Eastbound					Int. Total
	Right	Thru	Left	Peds	App. Total	Right	Thru	Left	Peds	App. Total	Right	Thru	Left	Peds	App. Total	Right	Thru	Left	Peds	App. Total	
04:00 PM	6	210	9	4	229	6	5	6	1	18	9	218	1	0	228	5	2	5	4	16	491
04:15 PM	7	254	4	0	265	7	8	3	0	18	10	195	2	0	207	8	5	7	2	22	512
04:30 PM	10	237	12	0	259	13	8	7	1	29	4	161	2	0	167	5	3	4	1	13	468
04:45 PM	18	272	11	0	301	9	10	9	0	28	10	195	4	0	209	7	6	6	0	19	557
Total	41	973	36	4	1054	35	31	25	2	93	33	769	9	0	811	25	16	22	7	70	2028
05:00 PM	17	275	23	2	317	12	4	4	0	20	6	220	9	1	236	8	8	7	0	23	596
05:15 PM	20	331	17	0	368	13	10	6	0	29	17	254	8	2	281	7	13	10	3	33	711
05:30 PM	34	317	18	0	369	7	17	5	0	29	18	242	5	0	265	10	16	11	2	39	702
05:45 PM	42	306	22	0	370	18	19	3	0	40	17	264	5	1	287	5	11	16	0	32	729
Total	113	1229	80	2	1424	50	50	18	0	118	58	980	27	4	1069	30	48	44	5	127	2738
06:00 PM	41	308	20	0	369	18	11	7	0	36	11	226	10	0	247	6	12	14	1	33	685
06:15 PM	35	278	28	1	342	11	5	4	1	21	10	230	9	0	249	9	13	8	1	31	643
06:30 PM	28	295	17	0	340	11	10	3	0	24	8	230	9	0	247	11	6	5	1	23	634
06:45 PM	29	331	20	0	380	8	6	9	0	23	10	215	5	0	230	5	4	5	3	17	650
Total	133	1212	85	1	1431	48	32	23	1	104	39	901	33	0	973	31	35	32	6	104	2612
Grand Total	287	3414	201	7	3909	133	113	66	3	315	130	2650	69	4	2853	86	99	98	18	301	7378
Apprch %	7.3	87.3	5.1	0.2		42.2	35.9	21	1		4.6	92.9	2.4	0.1		28.6	32.9	32.6	6		
Total %	3.9	46.3	2.7	0.1	53	1.8	1.5	0.9	0	4.3	1.8	35.9	0.9	0.1	38.7	1.2	1.3	1.3	0.2	4.1	

Start Time	WOLFE RD Southbound					INVERNESS WAY Westbound					WOLFE RD Northbound					INVERNESS WAY Eastbound					Int. Total
	Right	Thru	Left	Peds	App. Total	Right	Thru	Left	Peds	App. Total	Right	Thru	Left	Peds	App. Total	Right	Thru	Left	Peds	App. Total	
Peak Hour Analysis From 04:00 PM to 06:45 PM - Peak 1 of 1																					
Peak Hour for Entire Intersection Begins at 05:15 PM																					
05:15 PM	20	331	17	0	368	13	10	6	0	29	17	254	8	2	281	7	13	10	3	33	711
05:30 PM	34	317	18	0	369	7	17	5	0	29	18	242	5	0	265	10	16	11	2	39	702
05:45 PM	42	306	22	0	370	18	19	3	0	40	17	264	5	1	287	5	11	16	0	32	729
06:00 PM	41	308	20	0	369	18	11	7	0	36	11	226	10	0	247	6	12	14	1	33	685
Total Volume	137	1262	77	0	1476	56	57	21	0	134	63	986	28	3	1080	28	52	51	6	137	2827
% App. Total	9.3	85.5	5.2	0		41.8	42.5	15.7	0		5.8	91.3	2.6	0.3		20.4	38	37.2	4.4		
PHF	.815	.953	.875	.000	.997	.778	.750	.750	.000	.838	.875	.934	.700	.375	.941	.700	.813	.797	.500	.878	.969

Traffic Data Service

Campbell, CA
 (408) 377-2988
 tdsbay@cs.com

File Name : 4PM FINAL
 Site Code : 00000004
 Start Date : 1/26/2012
 Page No : 2

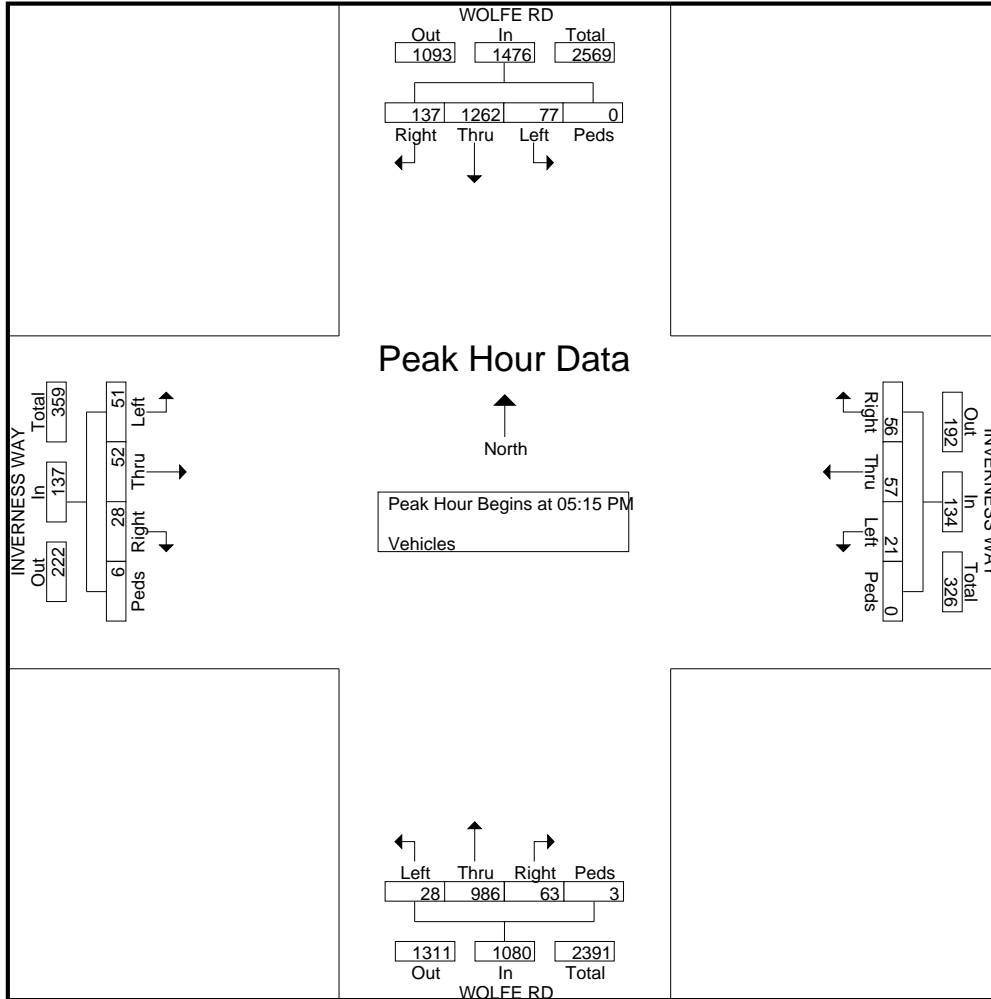

Traffic Data Service

Campbell, CA
(408) 377-2988
tdsbay@cs.com

File Name : 15AM FINAL
Site Code : 00000015
Start Date : 5/5/2011
Page No : 1

Groups Printed- Vehicles

Start Time	WOLFE RD Southbound					HOMESTEAD RD Westbound					WOLFE RD Northbound					HOMESTEAD RD Eastbound					Int. Total
	Right	Thru	Left	Peds	App. Total	Right	Thru	Left	Peds	App. Total	Right	Thru	Left	Peds	App. Total	Right	Thru	Left	Peds	App. Total	
06:30 AM	8	32	2	0	42	1	33	11	0	45	16	62	24	0	102	12	25	6	2	45	234
06:45 AM	7	100	10	0	117	3	47	27	0	77	34	108	59	1	202	22	36	4	2	64	460
Total	15	132	12	0	159	4	80	38	0	122	50	170	83	1	304	34	61	10	4	109	694
07:00 AM	10	106	9	0	125	4	60	35	0	99	30	102	45	0	177	21	36	9	1	67	468
07:15 AM	0	134	11	0	145	16	80	38	2	136	50	97	44	0	191	32	41	10	3	86	558
07:30 AM	10	187	11	1	209	16	82	48	0	146	55	124	41	0	220	47	67	18	1	133	708
07:45 AM	25	201	32	2	260	34	106	40	0	180	58	171	59	0	288	39	96	23	1	159	887
Total	45	628	63	3	739	70	328	161	2	561	193	494	189	0	876	139	240	60	6	445	2621
08:00 AM	25	174	27	0	226	37	157	74	0	268	30	225	65	0	320	34	122	25	0	181	995
08:15 AM	36	201	51	0	288	21	117	61	0	199	56	148	63	0	267	37	111	27	2	177	931
08:30 AM	24	214	28	0	266	28	125	58	0	211	60	244	59	0	363	59	120	36	0	215	1055
08:45 AM	32	185	35	0	252	23	146	64	0	233	47	209	77	4	337	51	110	38	1	200	1022
Total	117	774	141	0	1032	109	545	257	0	911	193	826	264	4	1287	181	463	126	3	773	4003
09:00 AM	26	165	37	1	229	24	112	44	0	180	44	170	99	2	315	27	85	21	0	133	857
09:15 AM	25	163	26	0	214	25	118	37	0	180	38	186	58	0	282	38	93	25	0	156	832
Grand Total	228	1862	279	4	2373	232	1183	537	2	1954	518	1846	693	7	3064	419	942	242	13	1616	9007
Apprch %	9.6	78.5	11.8	0.2		11.9	60.5	27.5	0.1		16.9	60.2	22.6	0.2		25.9	58.3	15	0.8		
Total %	2.5	20.7	3.1	0	26.3	2.6	13.1	6	0	21.7	5.8	20.5	7.7	0.1	34	4.7	10.5	2.7	0.1	17.9	

Start Time	WOLFE RD Southbound					HOMESTEAD RD Westbound					WOLFE RD Northbound					HOMESTEAD RD Eastbound					Int. Total
	Right	Thru	Left	Peds	App. Total	Right	Thru	Left	Peds	App. Total	Right	Thru	Left	Peds	App. Total	Right	Thru	Left	Peds	App. Total	
Peak Hour Analysis From 06:30 AM to 09:00 AM - Peak 1 of 1																					
Peak Hour for Entire Intersection Begins at 08:00 AM																					
08:00 AM	25	174	27	0	226	37	157	74	0	268	30	225	65	0	320	34	122	25	0	181	995
08:15 AM	36	201	51	0	288	21	117	61	0	199	56	148	63	0	267	37	111	27	2	177	931
08:30 AM	24	214	28	0	266	28	125	58	0	211	60	244	59	0	363	59	120	36	0	215	1055
08:45 AM	32	185	35	0	252	23	146	64	0	233	47	209	77	4	337	51	110	38	1	200	1022
Total Volume	117	774	141	0	1032	109	545	257	0	911	193	826	264	4	1287	181	463	126	3	773	4003
% App. Total	11.3	75	13.7	0		12	59.8	28.2	0		15	64.2	20.5	0.3		23.4	59.9	16.3	0.4		
PHF	.813	.904	.691	.000	.896	.736	.868	.868	.000	.850	.804	.846	.857	.250	.886	.767	.949	.829	.375	.899	.949

Traffic Data Service

Campbell, CA
 (408) 377-2988
 tdsbay@cs.com

File Name : 15AM FINAL
 Site Code : 00000015
 Start Date : 5/5/2011
 Page No : 2

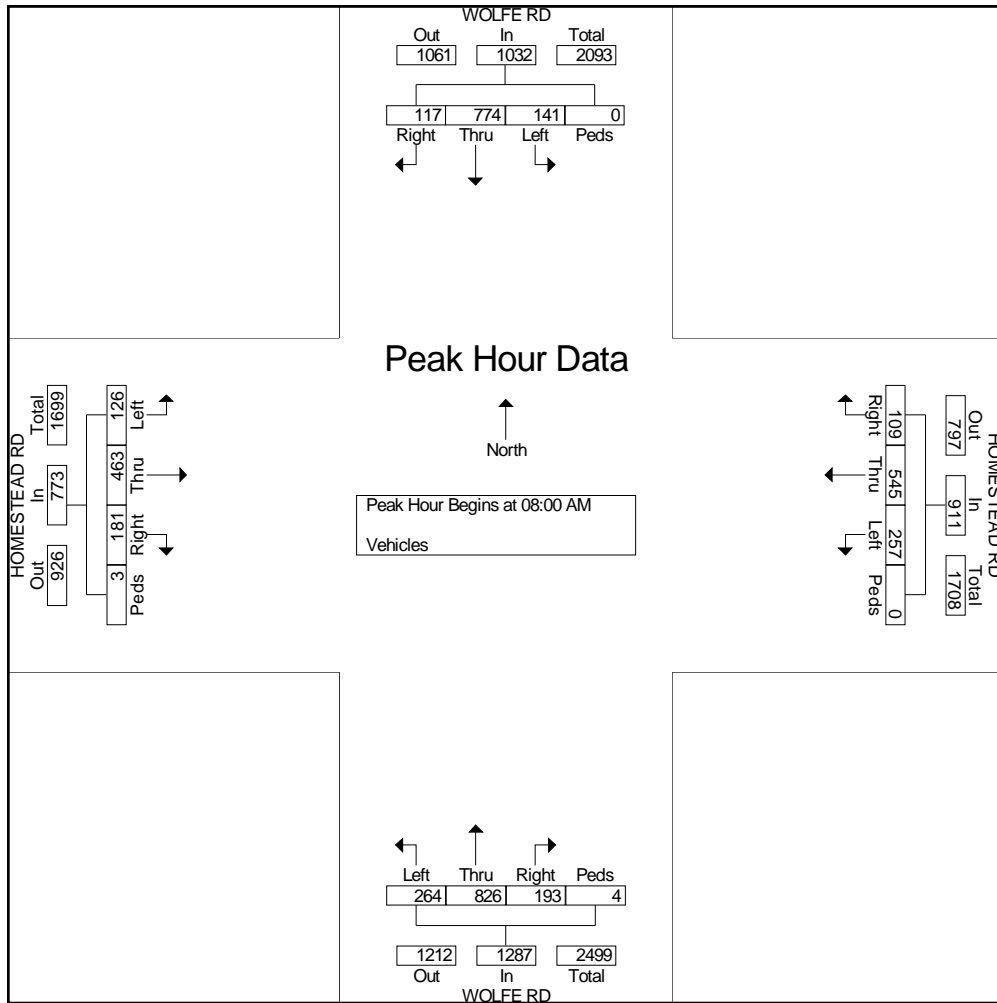

Traffic Data Service

Campbell, CA
(408) 377-2988
tdsbay@cs.com

File Name : 15PM FINAL
Site Code : 00000015
Start Date : 5/5/2011
Page No : 1

Groups Printed- Vehicles

Start Time	WOLFE RD Southbound					HOMESTEAD RD Westbound					WOLFE RD Northbound					HOMESTEAD RD Eastbound					Int. Total
	Right	Thru	Left	Peds	App. Total	Right	Thru	Left	Peds	App. Total	Right	Thru	Left	Peds	App. Total	Right	Thru	Left	Peds	App. Total	
04:00 PM	18	197	30	2	247	20	109	55	0	184	26	145	49	2	222	39	114	38	1	192	845
04:15 PM	26	231	37	2	296	27	101	85	2	215	40	136	36	8	220	40	118	24	1	183	914
04:30 PM	24	206	31	2	263	19	156	78	0	253	40	167	51	1	259	52	135	29	8	224	999
04:45 PM	32	250	26	0	308	29	119	70	0	218	46	142	61	2	251	55	139	29	2	225	1002
Total	100	884	124	6	1114	95	485	288	2	870	152	590	197	13	952	186	506	120	12	824	3760
05:00 PM	34	272	20	3	329	27	155	89	3	274	36	151	55	2	244	53	137	44	1	235	1082
05:15 PM	18	279	41	1	339	27	202	102	0	331	42	178	63	3	286	73	154	48	0	275	1231
05:30 PM	43	281	33	0	357	23	195	101	1	320	48	185	94	3	330	59	194	55	0	308	1315
05:45 PM	28	268	47	1	344	34	175	106	0	315	58	227	87	0	372	48	175	46	2	271	1302
Total	123	1100	141	5	1369	111	727	398	4	1240	184	741	299	8	1232	233	660	193	3	1089	4930
06:00 PM	32	285	38	2	357	24	201	135	0	360	41	168	78	0	287	71	190	52	2	315	1319
06:15 PM	34	277	43	0	354	23	211	91	0	325	33	197	67	1	298	52	134	36	1	223	1200
06:30 PM	30	279	32	0	341	20	159	111	0	290	30	143	64	0	237	51	156	43	1	251	1119
06:45 PM	31	207	28	2	268	13	164	74	1	252	49	198	65	3	315	53	127	44	1	225	1060
Total	127	1048	141	4	1320	80	735	411	1	1227	153	706	274	4	1137	227	607	175	5	1014	4698
Grand Total	350	3032	406	15	3803	286	1947	1097	7	3337	489	2037	770	25	3321	646	1773	488	20	2927	13388
Apprch %	9.2	79.7	10.7	0.4		8.6	58.3	32.9	0.2		14.7	61.3	23.2	0.8		22.1	60.6	16.7	0.7		
Total %	2.6	22.6	3	0.1	28.4	2.1	14.5	8.2	0.1	24.9	3.7	15.2	5.8	0.2	24.8	4.8	13.2	3.6	0.1	21.9	

Start Time	WOLFE RD Southbound					HOMESTEAD RD Westbound					WOLFE RD Northbound					HOMESTEAD RD Eastbound					Int. Total
	Right	Thru	Left	Peds	App. Total	Right	Thru	Left	Peds	App. Total	Right	Thru	Left	Peds	App. Total	Right	Thru	Left	Peds	App. Total	
Peak Hour Analysis From 04:00 PM to 06:45 PM - Peak 1 of 1																					
Peak Hour for Entire Intersection Begins at 05:15 PM																					
05:15 PM	18	279	41	1	339	27	202	102	0	331	42	178	63	3	286	73	154	48	0	275	1231
05:30 PM	43	281	33	0	357	23	195	101	1	320	48	185	94	3	330	59	194	55	0	308	1315
05:45 PM	28	268	47	1	344	34	175	106	0	315	58	227	87	0	372	48	175	46	2	271	1302
06:00 PM	32	285	38	2	357	24	201	135	0	360	41	168	78	0	287	71	190	52	2	315	1319
Total Volume	121	1113	159	4	1397	108	773	444	1	1326	189	758	322	6	1275	251	713	201	4	1169	5167
% App. Total	8.7	79.7	11.4	0.3		8.1	58.3	33.5	0.1		14.8	59.5	25.3	0.5		21.5	61	17.2	0.3		
PHF	.703	.976	.846	.500	.978	.794	.957	.822	.250	.921	.815	.835	.856	.500	.857	.860	.919	.914	.500	.928	.979

Traffic Data Service

Campbell, CA
 (408) 377-2988
 tdsbay@cs.com

File Name : 15PM FINAL
 Site Code : 00000015
 Start Date : 5/5/2011
 Page No : 2

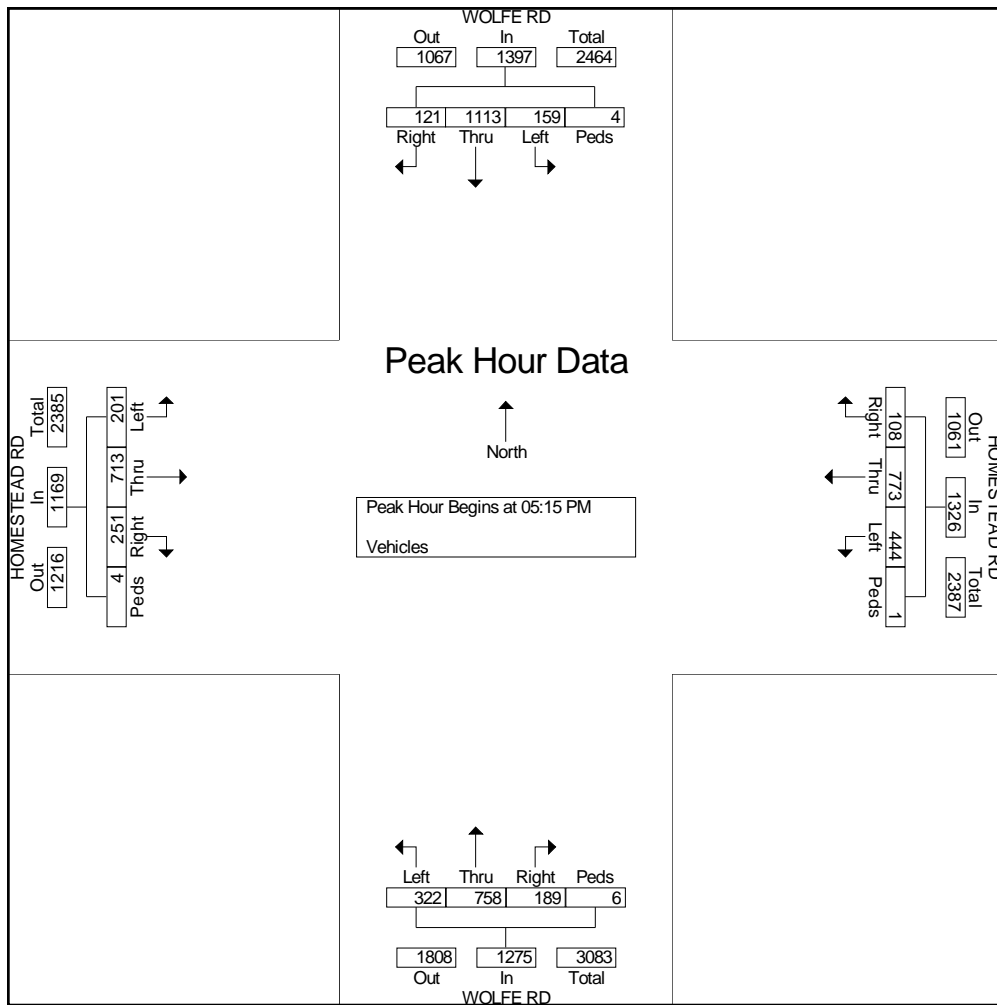

Traffic Data Service

Campbell, CA
(408) 377-2988
tdsbay@cs.com

File Name : 16AM FINAL
Site Code : 00000016
Start Date : 5/5/2011
Page No : 1

Groups Printed- Vehicles

Start Time	N. WOLFE RD Southbound					PRUNERIDGE AVE Westbound					N. WOLFE RD Northbound					PRUNERIDGE AVE Eastbound					Int. Total
	Right	Thru	Left	Peds	App. Total	Right	Thru	Left	Peds	App. Total	Right	Thru	Left	Peds	App. Total	Right	Thru	Left	Peds	App. Total	
06:30 AM	2	79	5	3	89	4	0	9	1	14	42	115	2	0	159	5	2	1	0	8	270
06:45 AM	3	137	10	2	152	4	2	16	0	22	50	184	6	0	240	9	0	5	0	14	428
Total	5	216	15	5	241	8	2	25	1	36	92	299	8	0	399	14	2	6	0	22	698
07:00 AM	4	163	2	0	169	11	1	17	0	29	48	162	12	0	222	10	1	11	0	22	442
07:15 AM	4	211	6	5	226	12	2	22	2	38	45	175	6	0	226	19	6	5	0	30	520
07:30 AM	6	276	10	1	293	21	1	27	0	49	68	247	15	0	330	18	4	9	0	31	703
07:45 AM	5	260	11	0	276	31	3	16	2	52	83	290	21	0	394	22	5	9	0	36	758
Total	19	910	29	6	964	75	7	82	4	168	244	874	54	0	1172	69	16	34	0	119	2423
08:00 AM	5	264	17	0	286	23	11	42	1	77	91	313	17	0	421	26	4	20	0	50	834
08:15 AM	2	328	21	1	352	27	4	33	0	64	107	345	18	0	470	31	5	13	0	49	935
08:30 AM	10	311	34	0	355	37	5	31	1	74	128	390	29	0	547	37	9	10	0	56	1032
08:45 AM	0	287	28	3	318	28	5	44	7	84	117	322	28	0	467	16	2	7	0	25	894
Total	17	1190	100	4	1311	115	25	150	9	299	443	1370	92	0	1905	110	20	50	0	180	3695
09:00 AM	12	245	25	7	289	47	1	44	2	94	105	359	23	0	487	16	2	10	0	28	898
09:15 AM	3	253	14	2	272	19	3	39	3	64	107	268	20	0	395	20	2	7	0	29	760
Grand Total	56	2814	183	24	3077	264	38	340	19	661	991	3170	197	0	4358	229	42	107	0	378	8474
Apprch %	1.8	91.5	5.9	0.8		39.9	5.7	51.4	2.9		22.7	72.7	4.5	0		60.6	11.1	28.3	0		
Total %	0.7	33.2	2.2	0.3	36.3	3.1	0.4	4	0.2	7.8	11.7	37.4	2.3	0	51.4	2.7	0.5	1.3	0	4.5	

Start Time	N. WOLFE RD Southbound					PRUNERIDGE AVE Westbound					N. WOLFE RD Northbound					PRUNERIDGE AVE Eastbound					Int. Total
	Right	Thru	Left	Peds	App. Total	Right	Thru	Left	Peds	App. Total	Right	Thru	Left	Peds	App. Total	Right	Thru	Left	Peds	App. Total	
Peak Hour Analysis From 06:30 AM to 09:15 AM - Peak 1 of 1																					
Peak Hour for Entire Intersection Begins at 08:15 AM																					
08:15 AM	2	328	21	1	352	27	4	33	0	64	107	345	18	0	470	31	5	13	0	49	935
08:30 AM	10	311	34	0	355	37	5	31	1	74	128	390	29	0	547	37	9	10	0	56	1032
08:45 AM	0	287	28	3	318	28	5	44	7	84	117	322	28	0	467	16	2	7	0	25	894
09:00 AM	12	245	25	7	289	47	1	44	2	94	105	359	23	0	487	16	2	10	0	28	898
Total Volume	24	1171	108	11	1314	139	15	152	10	316	457	1416	98	0	1971	100	18	40	0	158	3759
% App. Total	1.8	89.1	8.2	0.8		44	4.7	48.1	3.2		23.2	71.8	5	0		63.3	11.4	25.3	0		
PHF	.500	.893	.794	.393	.925	.739	.750	.864	.357	.840	.893	.908	.845	.000	.901	.676	.500	.769	.000	.705	.911

Traffic Data Service

Campbell, CA
 (408) 377-2988
 tdsbay@cs.com

File Name : 16AM FINAL
 Site Code : 00000016
 Start Date : 5/5/2011
 Page No : 2

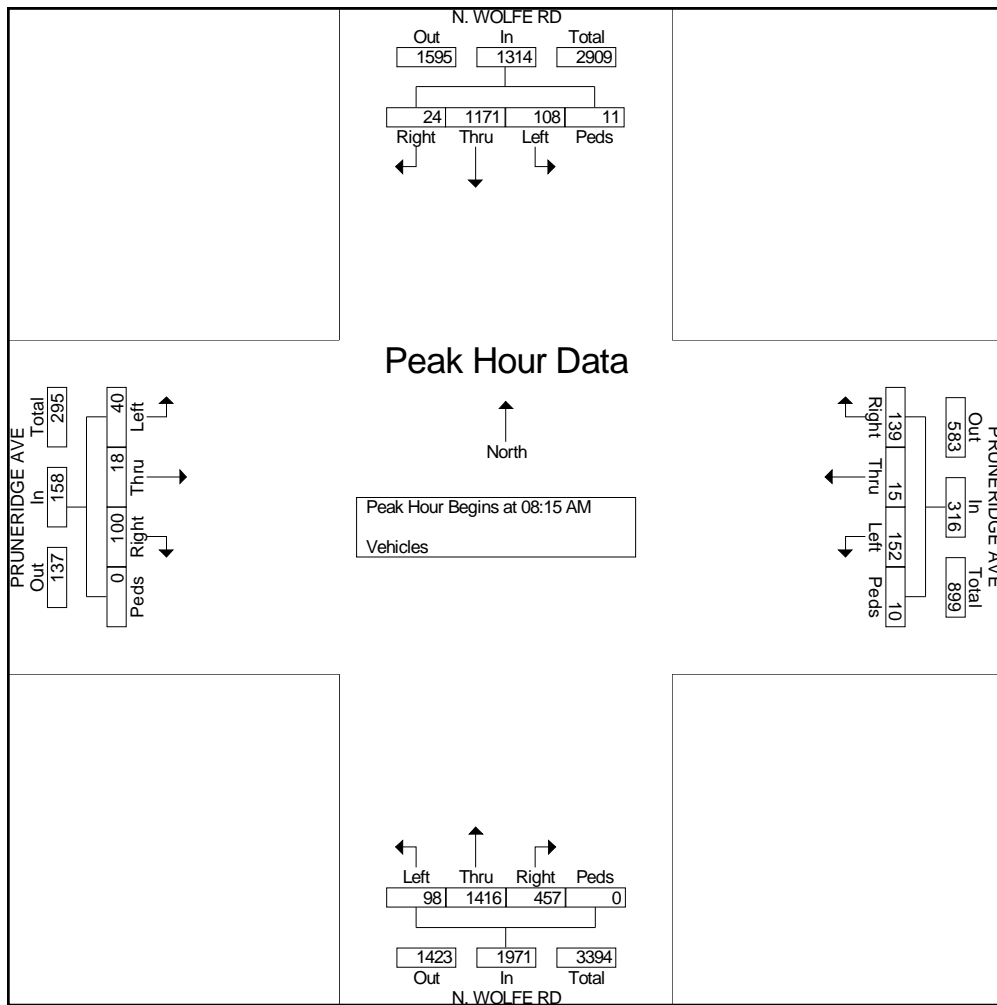

Traffic Data Service

Campbell, CA
(408) 377-2988
tdsbay@cs.com

File Name : 16PM FINAL
 Site Code : 00000016
 Start Date : 5/5/2011
 Page No : 1

Groups Printed- Vehicles

Start Time	N. WOLFE RD Southbound					PRUNERIDGE AVE Westbound					N. WOLFE RD Northbound					PRUNERIDGE AVE Eastbound					Int. Total
	Right	Thru	Left	Peds	App. Total	Right	Thru	Left	Peds	App. Total	Right	Thru	Left	Peds	App. Total	Right	Thru	Left	Peds	App. Total	
04:00 PM	8	279	16	1	304	16	12	86	0	114	44	208	40	0	292	22	2	4	0	28	738
04:15 PM	4	327	21	1	353	17	6	103	1	127	39	194	46	0	279	16	1	1	0	18	777
04:30 PM	8	308	23	2	341	23	8	90	3	124	31	229	41	3	304	28	1	5	0	34	803
04:45 PM	5	317	28	2	352	23	8	93	0	124	32	227	47	0	306	28	0	7	0	35	817
Total	25	1231	88	6	1350	79	34	372	4	489	146	858	174	3	1181	94	4	17	0	115	3135
05:00 PM	4	357	32	0	393	29	8	128	2	167	46	219	41	0	306	23	2	4	0	29	895
05:15 PM	20	339	28	1	388	30	16	174	0	220	80	284	36	1	401	40	4	5	0	49	1058
05:30 PM	17	402	30	1	450	42	10	138	4	194	63	268	41	5	377	27	1	11	0	39	1060
05:45 PM	16	396	15	1	428	50	12	122	0	184	50	333	59	3	445	18	2	4	0	24	1081
Total	57	1494	105	3	1659	151	46	562	6	765	239	1104	177	9	1529	108	9	24	0	141	4094
06:00 PM	14	374	24	1	413	39	10	112	1	162	50	273	61	0	384	30	6	10	0	46	1005
06:15 PM	11	387	45	1	444	35	17	140	1	193	54	299	75	0	428	35	4	7	0	46	1111
06:30 PM	14	374	34	0	422	33	7	108	0	148	50	251	65	2	368	25	2	14	0	41	979
06:45 PM	10	353	24	0	387	34	7	80	1	122	37	264	49	0	350	33	3	7	0	43	902
Total	49	1488	127	2	1666	141	41	440	3	625	191	1087	250	2	1530	123	15	38	0	176	3997
Grand Total	131	4213	320	11	4675	371	121	1374	13	1879	576	3049	601	14	4240	325	28	79	0	432	11226
Apprch %	2.8	90.1	6.8	0.2		19.7	6.4	73.1	0.7		13.6	71.9	14.2	0.3		75.2	6.5	18.3	0		
Total %	1.2	37.5	2.9	0.1	41.6	3.3	1.1	12.2	0.1	16.7	5.1	27.2	5.4	0.1	37.8	2.9	0.2	0.7	0	3.8	

Start Time	N. WOLFE RD Southbound					PRUNERIDGE AVE Westbound					N. WOLFE RD Northbound					PRUNERIDGE AVE Eastbound					Int. Total
	Right	Thru	Left	Peds	App. Total	Right	Thru	Left	Peds	App. Total	Right	Thru	Left	Peds	App. Total	Right	Thru	Left	Peds	App. Total	
Peak Hour Analysis From 04:00 PM to 06:45 PM - Peak 1 of 1																					
Peak Hour for Entire Intersection Begins at 05:30 PM																					
05:30 PM	17	402	30	1	450	42	10	138	4	194	63	268	41	5	377	27	1	11	0	39	1060
05:45 PM	16	396	15	1	428	50	12	122	0	184	50	333	59	3	445	18	2	4	0	24	1081
06:00 PM	14	374	24	1	413	39	10	112	1	162	50	273	61	0	384	30	6	10	0	46	1005
06:15 PM	11	387	45	1	444	35	17	140	1	193	54	299	75	0	428	35	4	7	0	46	1111
Total Volume	58	1559	114	4	1735	166	49	512	6	733	217	1173	236	8	1634	110	13	32	0	155	4257
% App. Total	3.3	89.9	6.6	0.2		22.6	6.7	69.8	0.8		13.3	71.8	14.4	0.5		71	8.4	20.6	0		
PHF	.853	.970	.633	1.000	.964	.830	.721	.914	.375	.945	.861	.881	.787	.400	.918	.786	.542	.727	.000	.842	.958

Traffic Data Service

Campbell, CA
 (408) 377-2988
 tdsbay@cs.com

File Name : 16PM FINAL
 Site Code : 00000016
 Start Date : 5/5/2011
 Page No : 2

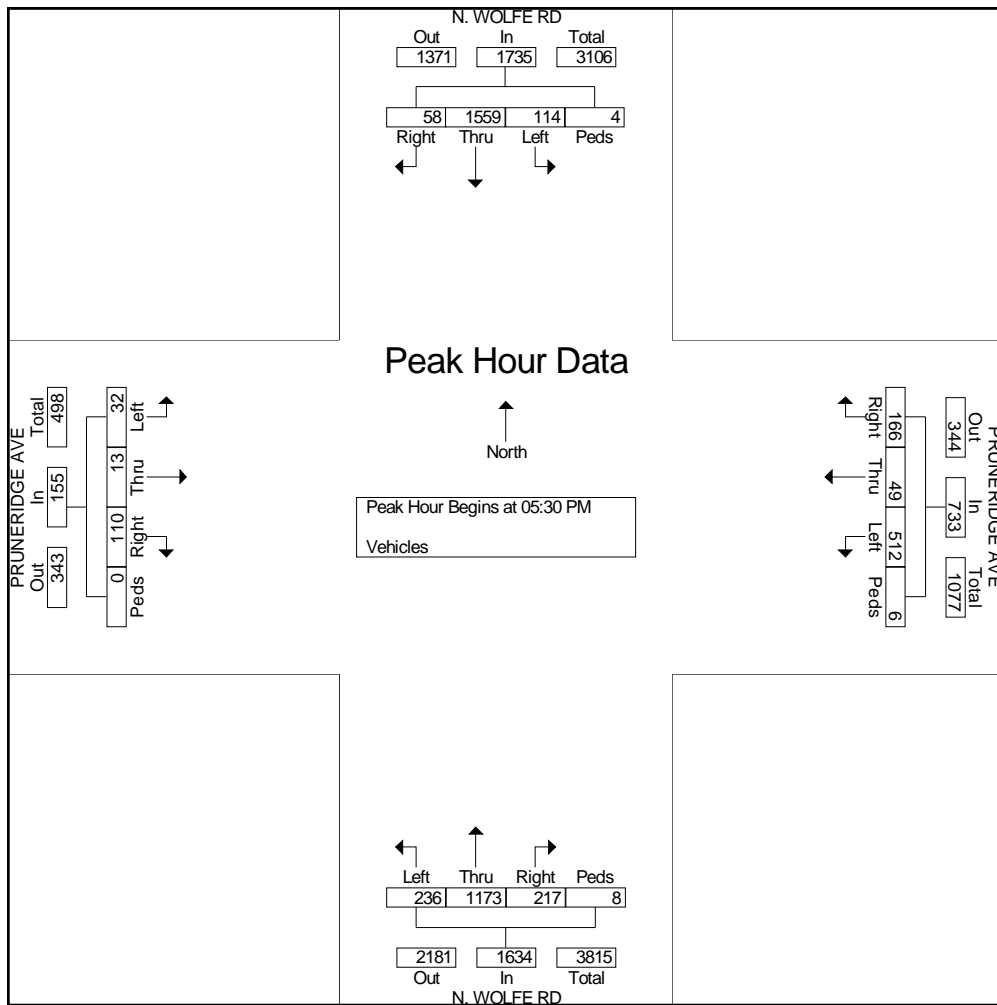

Traffic Data Service

Campbell, CA
(408) 377-2988
tdsbay@cs.com

File Name : 1AM FINAL
Site Code : 00000001
Start Date : 6/24/2015
Page No : 1

Groups Printed- Vehicles

Start Time	N WOLFE RD Southbound					I-280 NB RAMPS Westbound					N WOLFE RD Northbound					I-280 NB ON-RAMP Eastbound					Int. Total
	Right	Thru	Left	Peds	App. Total	Right	Thru	Left	Peds	App. Total	Right	Thru	Left	Peds	App. Total	Right	Thru	Left	Peds	App. Total	
07:00 AM	77	65	0	0	142	80	0	69	0	149	59	73	0	0	132	0	0	0	0	0	423
07:15 AM	87	93	0	0	180	63	0	62	0	125	71	90	0	0	161	0	0	0	0	0	466
07:30 AM	96	145	0	0	241	75	0	65	1	141	66	138	0	0	204	0	0	0	0	0	586
07:45 AM	105	143	0	0	248	78	0	58	1	137	115	181	0	0	296	0	0	0	0	0	681
Total	365	446	0	0	811	296	0	254	2	552	311	482	0	0	793	0	0	0	0	0	2156
08:00 AM	103	155	0	0	258	77	0	90	0	167	121	180	0	0	301	0	0	0	0	0	726
08:15 AM	115	211	0	0	326	66	0	70	0	136	110	220	0	0	330	0	0	0	0	0	792
08:30 AM	89	216	0	0	305	78	0	100	0	178	108	214	0	0	322	0	0	0	0	0	805
08:45 AM	87	185	0	0	272	92	0	122	1	215	104	223	0	0	327	0	0	0	0	0	814
Total	394	767	0	0	1161	313	0	382	1	696	443	837	0	0	1280	0	0	0	0	0	3137
09:00 AM	85	198	0	0	283	99	0	131	0	230	108	177	0	0	285	0	0	0	0	0	798
09:15 AM	120	163	0	0	283	85	0	162	0	247	90	194	0	0	284	0	0	0	0	0	814
09:30 AM	89	162	0	0	251	98	0	166	3	267	76	176	0	0	252	0	0	0	0	0	770
09:45 AM	92	165	0	0	257	113	0	192	0	305	80	147	0	0	227	0	0	0	0	0	789
Total	386	688	0	0	1074	395	0	651	3	1049	354	694	0	0	1048	0	0	0	0	0	3171
Grand Total	1145	1901	0	0	3046	1004	0	1287	6	2297	1108	2013	0	0	3121	0	0	0	0	0	8464
Apprch %	37.6	62.4	0	0		43.7	0	56	0.3		35.5	64.5	0	0		0	0	0	0	0	
Total %	13.5	22.5	0	0	36	11.9	0	15.2	0.1	27.1	13.1	23.8	0	0	36.9	0	0	0	0	0	

Start Time	N WOLFE RD Southbound				I-280 NB RAMPS Westbound				N WOLFE RD Northbound				I-280 NB ON-RAMP Eastbound				Int. Total
	Right	Thru	Left	App. Total	Right	Thru	Left	App. Total	Right	Thru	Left	App. Total	Right	Thru	Left	App. Total	
Peak Hour Analysis From 07:00 AM to 09:45 AM - Peak 1 of 1																	
Peak Hour for Entire Intersection Begins at 08:30 AM																	
08:30 AM	89	216	0	305	78	0	100	178	108	214	0	322	0	0	0	0	805
08:45 AM	87	185	0	272	92	0	122	214	104	223	0	327	0	0	0	0	813
09:00 AM	85	198	0	283	99	0	131	230	108	177	0	285	0	0	0	0	798
09:15 AM	120	163	0	283	85	0	162	247	90	194	0	284	0	0	0	0	814
Total Volume	381	762	0	1143	354	0	515	869	410	808	0	1218	0	0	0	0	3230
% App. Total	33.3	66.7	0		40.7	0	59.3		33.7	66.3	0		0	0	0		
PHF	.794	.882	.000	.937	.894	.000	.795	.880	.949	.906	.000	.931	.000	.000	.000	.000	.992

Traffic Data Service

Campbell, CA
(408) 377-2988
tdsbay@cs.com

File Name : 1AM FINAL

Site Code : 00000001

Start Date : 6/24/2015

Page No : 2

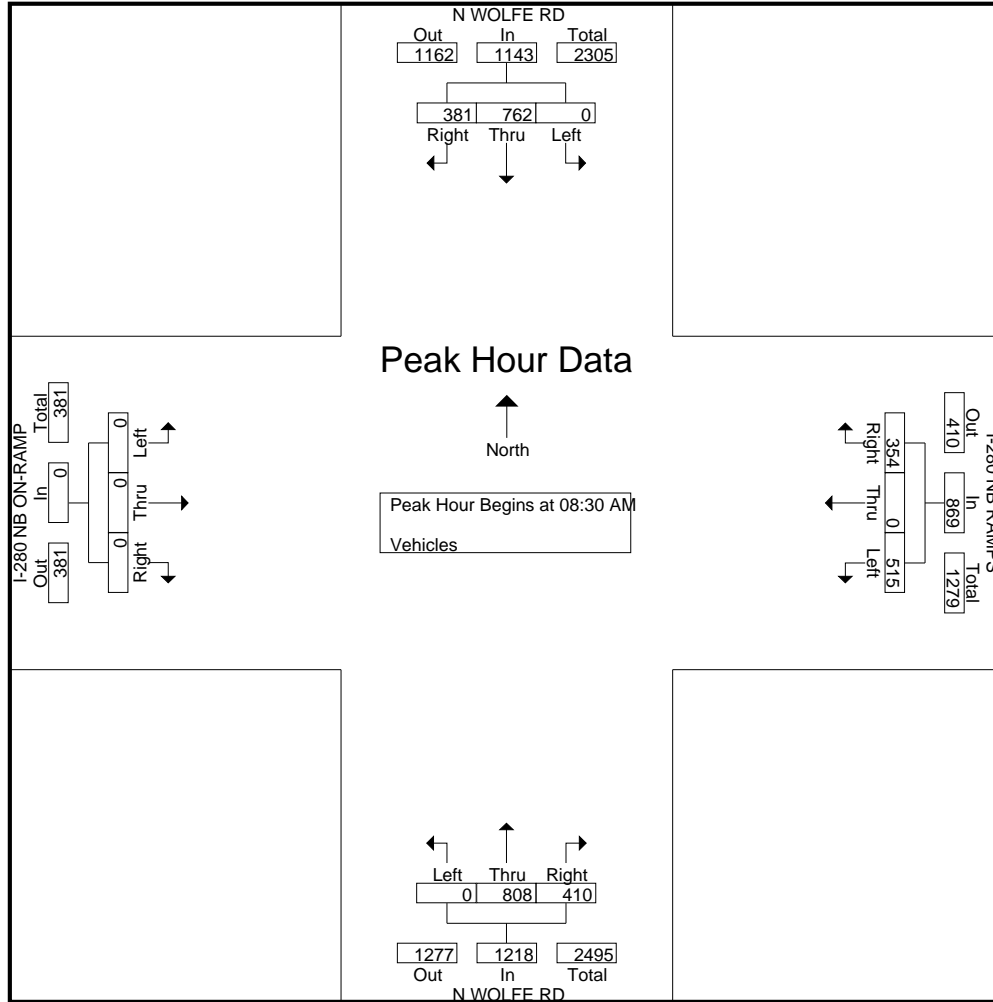

Traffic Data Service

Campbell, CA
 (408) 377-2988
 tdsbay@cs.com

File Name : 1PM FINAL
 Site Code : 00000001
 Start Date : 6/24/2015
 Page No : 1

Groups Printed- Vehicles

Start Time	N WOLFE RD Southbound					I-280 NB RAMPS Westbound					N WOLFE RD Northbound					I-280 NB ON-RAMP Eastbound					Int. Total
	Right	Thru	Left	Peds	App. Total	Right	Thru	Left	Peds	App. Total	Right	Thru	Left	Peds	App. Total	Right	Thru	Left	Peds	App. Total	
04:00 PM	77	206	0	0	283	79	0	105	0	184	100	135	0	0	235	0	0	0	0	0	702
04:15 PM	78	237	0	0	315	84	0	99	3	186	97	115	0	0	212	0	0	0	0	0	713
04:30 PM	88	277	0	0	365	85	0	104	0	189	101	122	0	0	223	0	0	0	0	0	777
04:45 PM	83	241	0	0	324	101	0	135	1	237	84	120	0	0	204	0	0	0	0	0	765
Total	326	961	0	0	1287	349	0	443	4	796	382	492	0	0	874	0	0	0	0	0	2957
05:00 PM	113	280	0	0	393	96	0	111	0	207	117	135	0	0	252	0	0	0	0	0	852
05:15 PM	114	308	0	0	422	116	0	136	0	252	118	120	0	0	238	0	0	0	0	0	912
05:30 PM	104	290	0	0	394	104	0	136	0	240	122	156	0	0	278	0	0	0	0	0	912
05:45 PM	115	280	0	0	395	114	0	162	1	277	101	170	0	0	271	0	0	0	0	0	943
Total	446	1158	0	0	1604	430	0	545	1	976	458	581	0	0	1039	0	0	0	0	0	3619
06:00 PM	94	318	0	0	412	90	0	146	1	237	124	137	0	0	261	0	0	0	0	0	910
06:15 PM	100	296	0	0	396	99	0	115	0	214	116	174	0	0	290	0	0	0	0	0	900
06:30 PM	76	267	0	0	343	90	0	115	0	205	72	166	0	0	238	0	0	0	0	0	786
06:45 PM	64	277	0	0	341	97	0	154	0	251	87	135	0	0	222	0	0	0	0	0	814
Total	334	1158	0	0	1492	376	0	530	1	907	399	612	0	0	1011	0	0	0	0	0	3410
Grand Total	1106	3277	0	0	4383	1155	0	1518	6	2679	1239	1685	0	0	2924	0	0	0	0	0	9986
Apprch %	25.2	74.8	0	0		43.1	0	56.7	0.2		42.4	57.6	0	0		0	0	0	0	0	
Total %	11.1	32.8	0	0	43.9	11.6	0	15.2	0.1	26.8	12.4	16.9	0	0	29.3	0	0	0	0	0	

Start Time	N WOLFE RD Southbound				I-280 NB RAMPS Westbound				N WOLFE RD Northbound				I-280 NB ON-RAMP Eastbound				Int. Total
	Right	Thru	Left	App. Total	Right	Thru	Left	App. Total	Right	Thru	Left	App. Total	Right	Thru	Left	App. Total	
Peak Hour Analysis From 04:00 PM to 06:45 PM - Peak 1 of 1																	
Peak Hour for Entire Intersection Begins at 05:15 PM																	
05:15 PM	114	308	0	422	116	0	136	252	118	120	0	238	0	0	0	0	912
05:30 PM	104	290	0	394	104	0	136	240	122	156	0	278	0	0	0	0	912
05:45 PM	115	280	0	395	114	0	162	276	101	170	0	271	0	0	0	0	942
06:00 PM	94	318	0	412	90	0	146	236	124	137	0	261	0	0	0	0	909
Total Volume	427	1196	0	1623	424	0	580	1004	465	583	0	1048	0	0	0	0	3675
% App. Total	26.3	73.7	0		42.2	0	57.8		44.4	55.6	0		0	0	0		
PHF	.928	.940	.000	.961	.914	.000	.895	.909	.938	.857	.000	.942	.000	.000	.000	.000	.975

Traffic Data Service

Campbell, CA
 (408) 377-2988
tdsbay@cs.com

File Name : 1PM FINAL

Site Code : 00000001

Start Date : 6/24/2015

Page No : 2

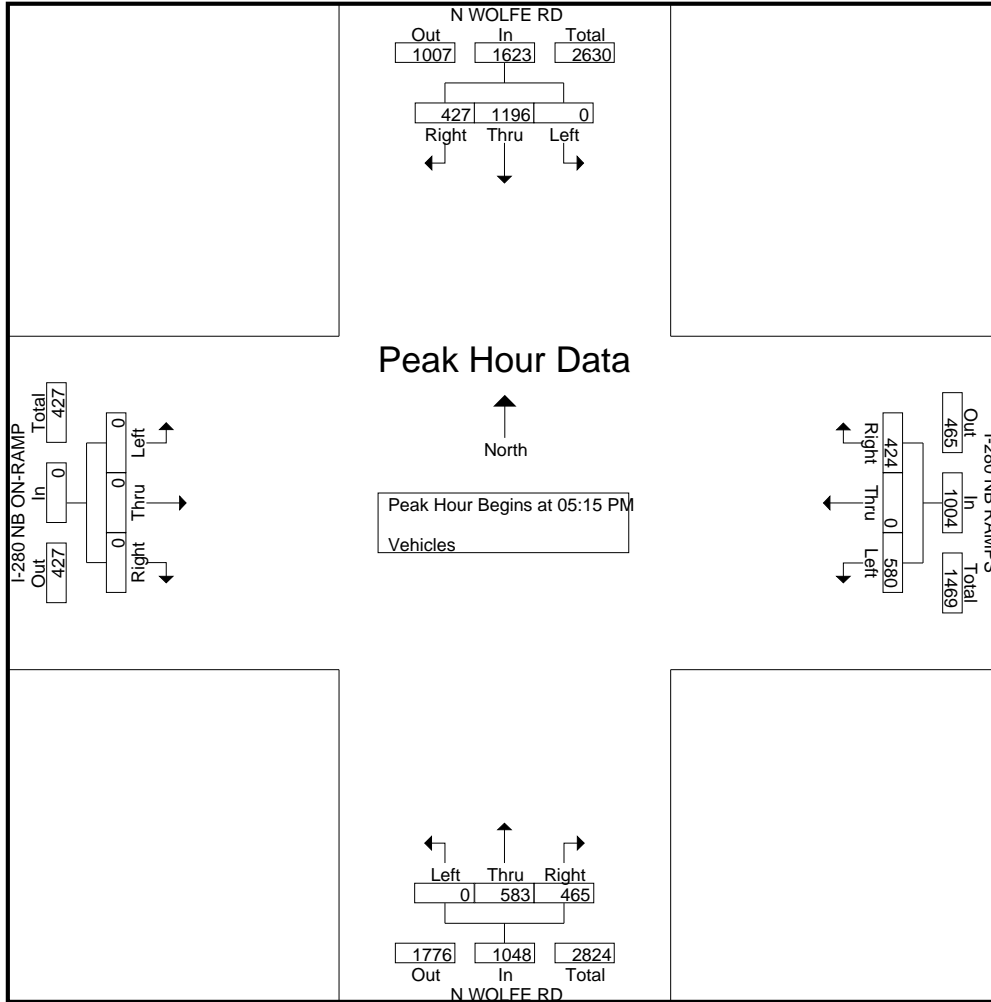

Traffic Data Service

Campbell, CA
(408) 377-2988
tdsbay@cs.com

File Name : 2AM FINAL
Site Code : 00000002
Start Date : 6/24/2015
Page No : 1

Groups Printed- Vehicles

Start Time	N WOLFE RD Southbound					I-280 SB ON-RAMP Westbound					N WOLFE RD Northbound					I-280 SB RAMPS Eastbound					Int. Total
	Right	Thru	Left	Peds	App. Total	Right	Thru	Left	Peds	App. Total	Right	Thru	Left	Peds	App. Total	Right	Thru	Left	Peds	App. Total	
07:00 AM	45	87	0	0	132	0	0	0	0	0	29	89	0	0	118	34	0	45	1	80	330
07:15 AM	57	96	0	0	153	0	0	0	0	0	37	103	0	0	140	48	0	59	0	107	400
07:30 AM	92	116	0	0	208	0	0	0	0	0	65	137	0	0	202	85	0	70	0	155	565
07:45 AM	75	125	0	0	200	0	0	0	0	0	48	200	0	0	248	119	0	98	2	219	667
Total	269	424	0	0	693	0	0	0	0	0	179	529	0	0	708	286	0	272	3	561	1962
08:00 AM	88	155	0	0	243	0	0	0	0	0	75	226	0	0	301	77	0	78	1	156	700
08:15 AM	100	178	0	0	278	0	0	0	0	0	96	222	0	0	318	105	0	110	6	221	817
08:30 AM	121	193	0	0	314	0	0	0	0	0	97	220	0	0	317	115	0	104	1	220	851
08:45 AM	78	227	0	0	305	0	0	0	0	0	88	233	0	0	321	104	0	97	1	202	828
Total	387	753	0	0	1140	0	0	0	0	0	356	901	0	0	1257	401	0	389	9	799	3196
09:00 AM	96	231	0	0	327	0	0	0	0	0	88	222	0	0	310	109	0	67	1	177	814
09:15 AM	75	247	0	0	322	0	0	0	0	0	92	203	0	0	295	112	0	83	3	198	815
09:30 AM	77	249	0	0	326	0	0	0	0	0	96	182	0	0	278	95	0	72	2	169	773
09:45 AM	88	266	0	0	354	0	0	0	0	0	73	180	0	0	253	110	0	50	2	162	769
Total	336	993	0	0	1329	0	0	0	0	0	349	787	0	0	1136	426	0	272	8	706	3171
Grand Total	992	2170	0	0	3162	0	0	0	0	0	884	2217	0	0	3101	1113	0	933	20	2066	8329
Apprch %	31.4	68.6	0	0		0	0	0	0		28.5	71.5	0	0		53.9	0	45.2	1		
Total %	11.9	26.1	0	0	38	0	0	0	0	0	10.6	26.6	0	0	37.2	13.4	0	11.2	0.2	24.8	

Start Time	N WOLFE RD Southbound				I-280 SB ON-RAMP Westbound				N WOLFE RD Northbound				I-280 SB RAMPS Eastbound				Int. Total
	Right	Thru	Left	App. Total	Right	Thru	Left	App. Total	Right	Thru	Left	App. Total	Right	Thru	Left	App. Total	
Peak Hour Analysis From 07:00 AM to 09:45 AM - Peak 1 of 1																	
Peak Hour for Entire Intersection Begins at 08:30 AM																	
08:30 AM	121	193	0	314	0	0	0	0	97	220	0	317	115	0	104	219	850
08:45 AM	78	227	0	305	0	0	0	0	88	233	0	321	104	0	97	201	827
09:00 AM	96	231	0	327	0	0	0	0	88	222	0	310	109	0	67	176	813
09:15 AM	75	247	0	322	0	0	0	0	92	203	0	295	112	0	83	195	812
Total Volume	370	898	0	1268	0	0	0	0	365	878	0	1243	440	0	351	791	3302
% App. Total	29.2	70.8	0		0	0	0		29.4	70.6	0		55.6	0	44.4		
PHF	.764	.909	.000	.969	.000	.000	.000	.000	.941	.942	.000	.968	.957	.000	.844	.903	.971

Traffic Data Service

Campbell, CA
 (408) 377-2988
tdsbay@cs.com

File Name : 2AM FINAL

Site Code : 00000002

Start Date : 6/24/2015

Page No : 2

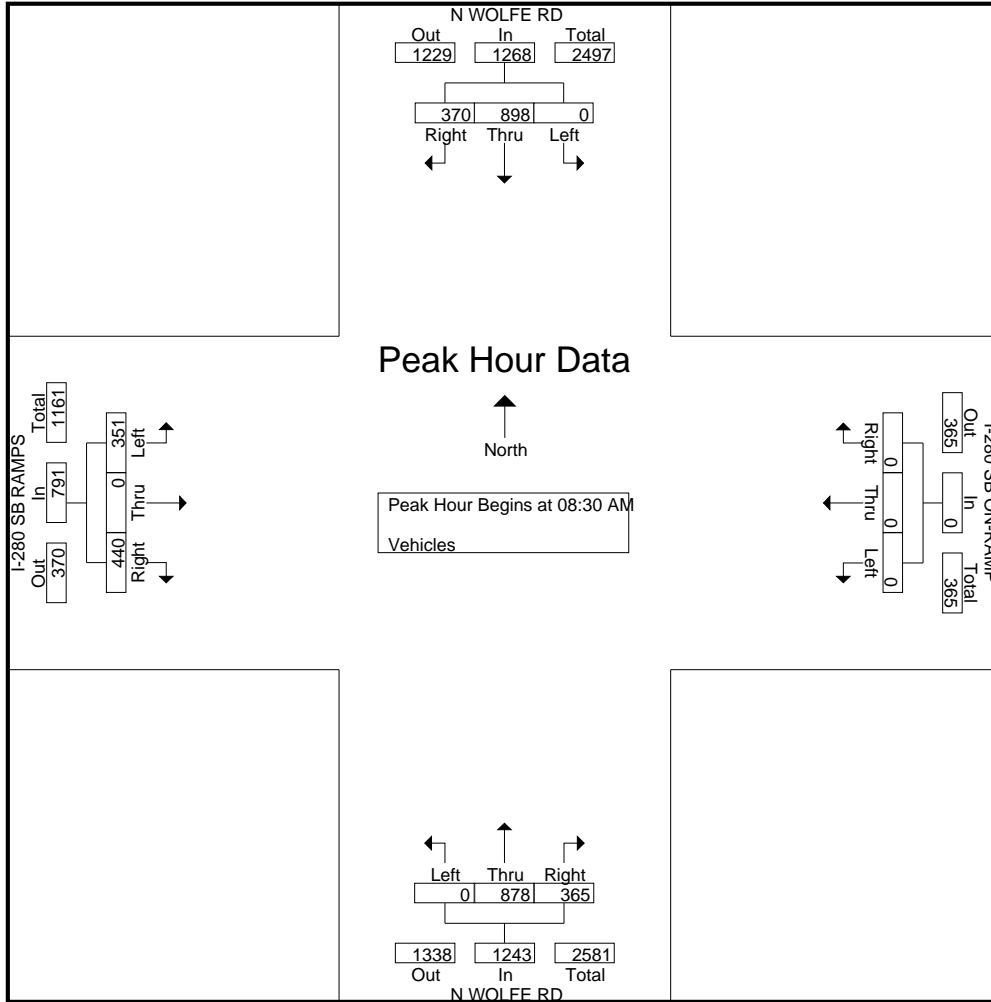

Traffic Data Service

Campbell, CA
 (408) 377-2988
 tdsbay@cs.com

File Name : 2PM FINAL
 Site Code : 00000002
 Start Date : 6/24/2015
 Page No : 1

Groups Printed- Vehicles

Start Time	N WOLFE RD Southbound					I-280 SB ON-RAMP Westbound					N WOLFE RD Northbound					I-280 SB RAMPS Eastbound					Int. Total
	Right	Thru	Left	Peds	App. Total	Right	Thru	Left	Peds	App. Total	Right	Thru	Left	Peds	App. Total	Right	Thru	Left	Peds	App. Total	
04:00 PM	110	199	0	0	309	0	0	0	0	0	155	197	0	0	352	56	0	40	0	96	757
04:15 PM	118	216	0	0	334	0	0	0	0	0	101	184	0	0	285	56	0	31	1	88	707
04:30 PM	136	242	0	0	378	0	0	0	0	0	123	201	0	0	324	55	0	25	0	80	782
04:45 PM	119	255	0	0	374	0	0	0	0	0	109	173	0	0	282	51	0	33	0	84	740
Total	483	912	0	0	1395	0	0	0	0	0	488	755	0	0	1243	218	0	129	1	348	2986
05:00 PM	151	237	0	0	388	0	0	0	0	0	155	219	0	0	374	61	0	35	1	97	859
05:15 PM	136	305	0	0	441	0	0	0	0	0	138	210	0	0	348	64	0	29	2	95	884
05:30 PM	121	304	0	0	425	0	0	0	0	0	122	246	0	0	368	61	0	34	0	95	888
05:45 PM	107	335	0	0	442	0	0	0	0	0	106	232	0	0	338	76	0	41	1	118	898
Total	515	1181	0	0	1696	0	0	0	0	0	521	907	0	0	1428	262	0	139	4	405	3529
06:00 PM	118	345	0	0	463	0	0	0	0	0	136	231	0	0	367	72	0	31	3	106	936
06:15 PM	101	307	0	0	408	0	0	0	0	0	139	245	0	0	384	67	0	48	1	116	908
06:30 PM	90	292	0	0	382	0	0	0	0	0	136	185	0	0	321	80	0	53	0	133	836
06:45 PM	145	284	0	0	429	0	0	0	0	0	99	174	0	0	273	84	0	49	1	134	836
Total	454	1228	0	0	1682	0	0	0	0	0	510	835	0	0	1345	303	0	181	5	489	3516
Grand Total	1452	3321	0	0	4773	0	0	0	0	0	1519	2497	0	0	4016	783	0	449	10	1242	10031
Apprch %	30.4	69.6	0	0		0	0	0	0	0	37.8	62.2	0	0		63	0	36.2	0.8		
Total %	14.5	33.1	0	0	47.6	0	0	0	0	0	15.1	24.9	0	0	40	7.8	0	4.5	0.1	12.4	

Start Time	N WOLFE RD Southbound				I-280 SB ON-RAMP Westbound				N WOLFE RD Northbound				I-280 SB RAMPS Eastbound				Int. Total
	Right	Thru	Left	App. Total	Right	Thru	Left	App. Total	Right	Thru	Left	App. Total	Right	Thru	Left	App. Total	
Peak Hour Analysis From 04:00 PM to 06:45 PM - Peak 1 of 1																	
Peak Hour for Entire Intersection Begins at 05:30 PM																	
05:30 PM	121	304	0	425	0	0	0	0	122	246	0	368	61	0	34	95	888
05:45 PM	107	335	0	442	0	0	0	0	106	232	0	338	76	0	41	117	897
06:00 PM	118	345	0	463	0	0	0	0	136	231	0	367	72	0	31	103	933
06:15 PM	101	307	0	408	0	0	0	0	139	245	0	384	67	0	48	115	907
Total Volume	447	1291	0	1738	0	0	0	0	503	954	0	1457	276	0	154	430	3625
% App. Total	25.7	74.3	0		0	0	0	0	34.5	65.5	0		64.2	0	35.8		
PHF	.924	.936	.000	.938	.000	.000	.000	.000	.905	.970	.000	.949	.908	.000	.802	.919	.971

Traffic Data Service

Campbell, CA
 (408) 377-2988
tdsbay@cs.com

File Name : 2PM FINAL

Site Code : 00000002

Start Date : 6/24/2015

Page No : 2

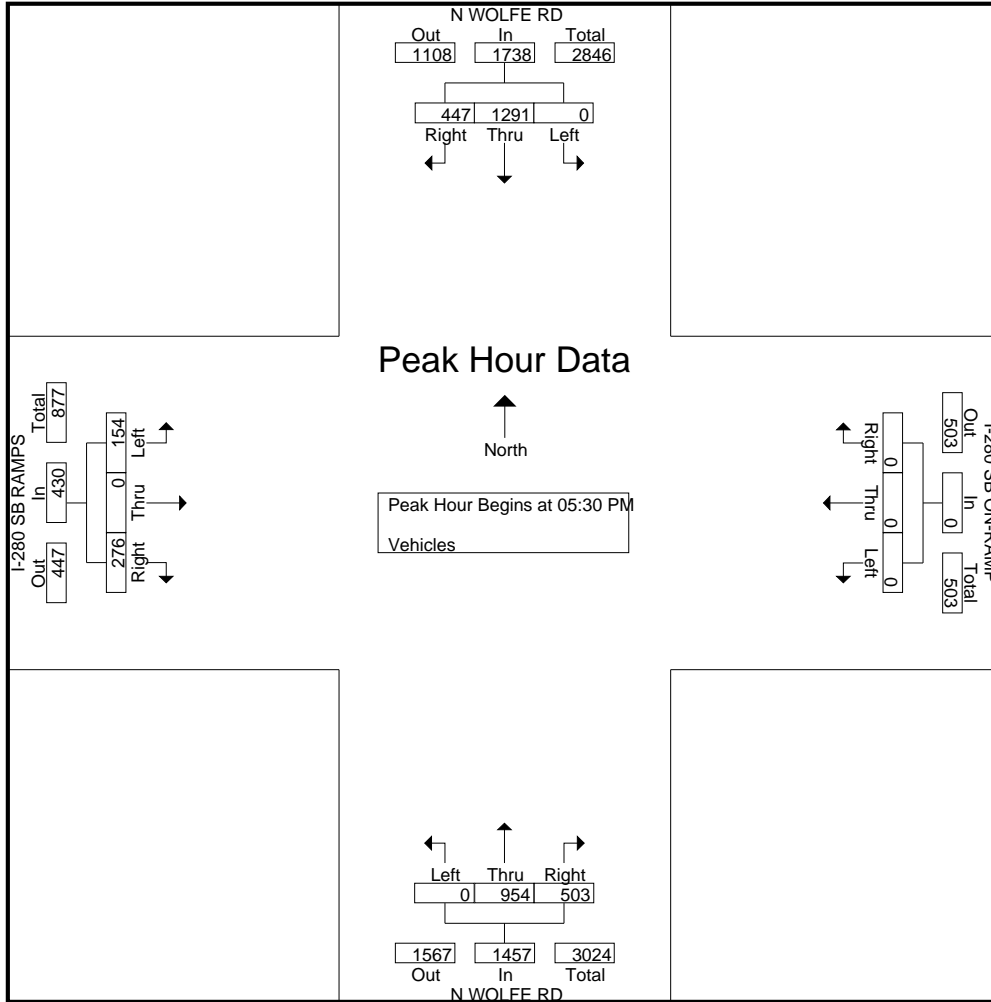

Traffic Data Service

Campbell, CA
 (408) 377-2988
 tdsbay@cs.com

File Name : 14AM FINAL
 Site Code : 00000014
 Start Date : 3/31/2015
 Page No : 1

Groups Printed- Vehicles

Start Time	N WOLFE RD Southbound					VALLCO PKWY Westbound					N WOLFE RD Northbound					DRIVEWAY Eastbound					Int. Total
	Right	Thru	Left	Peds	App. Total	Right	Thru	Left	Peds	App. Total	Right	Thru	Left	Peds	App. Total	Right	Thru	Left	Peds	App. Total	
07:00 AM	1	94	29	0	124	11	0	4	0	15	8	93	2	0	103	0	0	1	1	2	244
07:15 AM	0	116	37	1	154	21	1	6	1	29	34	163	1	1	199	0	0	1	0	1	383
07:30 AM	1	127	51	1	180	28	1	12	2	43	33	272	4	0	309	0	1	1	1	3	535
07:45 AM	3	141	30	0	174	33	2	13	0	48	22	267	3	0	292	0	0	3	2	5	519
Total	5	478	147	2	632	93	4	35	3	135	97	795	10	1	903	0	1	6	4	11	1681
08:00 AM	3	218	46	2	269	30	2	15	0	47	11	219	4	1	235	1	0	2	1	4	555
08:15 AM	2	214	59	0	275	30	1	14	0	45	23	308	3	1	335	0	1	4	1	6	661
08:30 AM	2	224	89	2	317	26	0	22	1	49	24	416	4	1	445	1	3	3	1	8	819
08:45 AM	3	268	100	0	371	35	0	12	0	47	37	401	3	0	441	0	2	0	3	5	864
Total	10	924	294	4	1232	121	3	63	1	188	95	1344	14	3	1456	2	6	9	6	23	2899
09:00 AM	2	162	64	0	228	31	1	11	1	44	30	265	4	1	300	0	0	1	0	1	573
09:15 AM	4	200	76	2	282	40	1	10	1	52	23	218	5	1	247	0	1	6	1	8	589
09:30 AM	10	192	85	0	287	27	0	12	0	39	20	193	5	2	220	1	1	5	2	9	555
09:45 AM	6	229	74	2	311	28	2	11	1	42	32	171	9	1	213	1	0	0	1	2	568
Total	22	783	299	4	1108	126	4	44	3	177	105	847	23	5	980	2	2	12	4	20	2285
Grand Total	37	2185	740	10	2972	340	11	142	7	500	297	2986	47	9	3339	4	9	27	14	54	6865
Apprch %	1.2	73.5	24.9	0.3		68	2.2	28.4	1.4		8.9	89.4	1.4	0.3		7.4	16.7	50	25.9		
Total %	0.5	31.8	10.8	0.1	43.3	5	0.2	2.1	0.1	7.3	4.3	43.5	0.7	0.1	48.6	0.1	0.1	0.4	0.2	0.8	

Start Time	N WOLFE RD Southbound				VALLCO PKWY Westbound				N WOLFE RD Northbound				DRIVEWAY Eastbound				Int. Total
	Right	Thru	Left	App. Total	Right	Thru	Left	App. Total	Right	Thru	Left	App. Total	Right	Thru	Left	App. Total	
Peak Hour Analysis From 07:00 AM to 09:45 AM - Peak 1 of 1																	
Peak Hour for Entire Intersection Begins at 08:15 AM																	
08:15 AM	2	214	59	275	30	1	14	45	23	308	3	334	0	1	4	5	659
08:30 AM	2	224	89	315	26	0	22	48	24	416	4	444	1	3	3	7	814
08:45 AM	3	268	100	371	35	0	12	47	37	401	3	441	0	2	0	2	861
09:00 AM	2	162	64	228	31	1	11	43	30	265	4	299	0	0	1	1	571
Total Volume	9	868	312	1189	122	2	59	183	114	1390	14	1518	1	6	8	15	2905
% App. Total	0.8	73	26.2		66.7	1.1	32.2		7.5	91.6	0.9		6.7	40	53.3		
PHF	.750	.810	.780	.801	.871	.500	.670	.953	.770	.835	.875	.855	.250	.500	.500	.536	.843

Traffic Data Service

Campbell, CA
 (408) 377-2988
tdsbay@cs.com

File Name : 14AM FINAL
 Site Code : 00000014
 Start Date : 3/31/2015
 Page No : 2

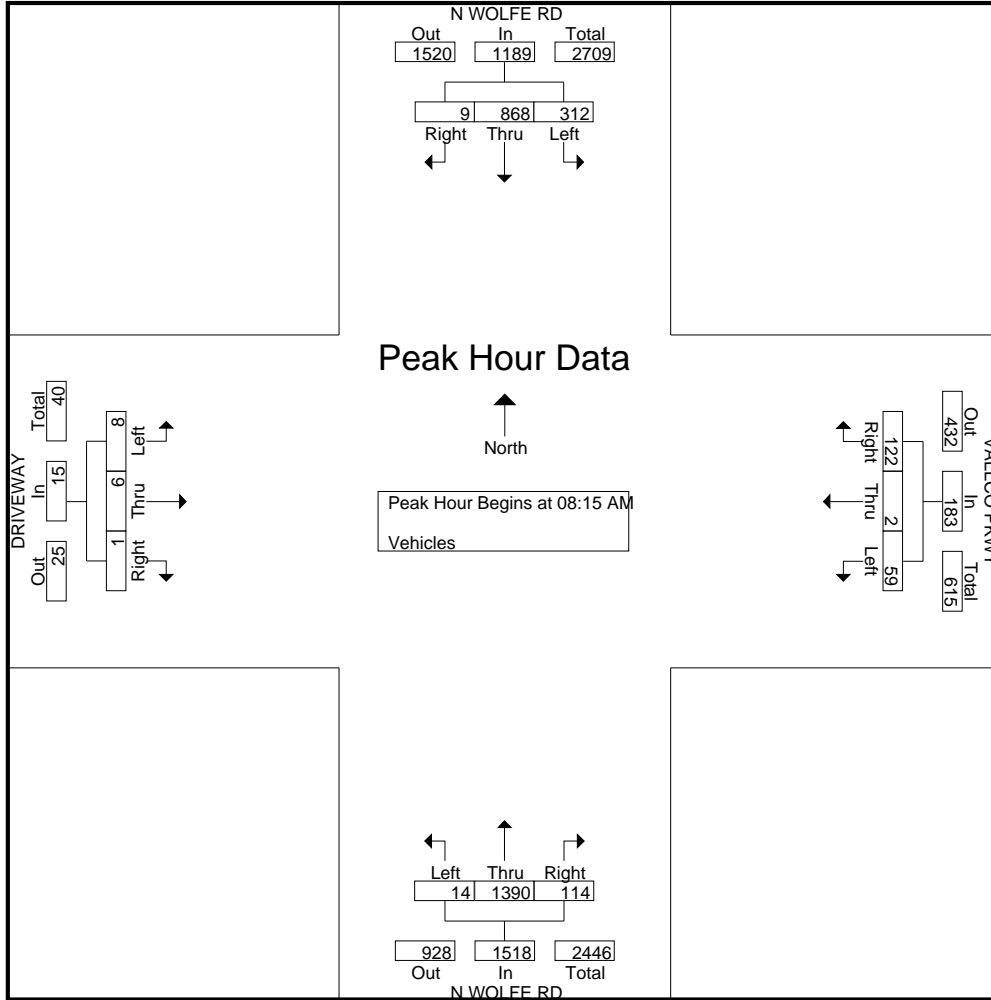

Traffic Data Service

Campbell, CA
(408) 377-2988
tdsbay@cs.com

File Name : 14PM FINAL
Site Code : 00000014
Start Date : 3/31/2015
Page No : 1

Groups Printed- Vehicles

Start Time	N WOLFE RD Southbound					VALLCO PKWY Westbound					N WOLFE RD Northbound					DRIVEWAY Eastbound					Int. Total
	Right	Thru	Left	Peds	App. Total	Right	Thru	Left	Peds	App. Total	Right	Thru	Left	Peds	App. Total	Right	Thru	Left	Peds	App. Total	
04:00 PM	0	198	43	7	248	85	2	28	2	117	18	189	16	0	223	5	3	14	0	22	610
04:15 PM	2	167	33	0	202	68	5	23	5	101	19	173	8	0	200	5	3	10	0	18	521
04:30 PM	7	166	30	2	205	78	1	23	3	105	22	193	11	1	227	3	2	10	1	16	553
04:45 PM	7	214	50	4	275	80	4	23	1	108	22	220	10	0	252	5	1	13	0	19	654
Total	16	745	156	13	930	311	12	97	11	431	81	775	45	1	902	18	9	47	1	75	2338
05:00 PM	8	227	38	1	274	89	1	27	0	117	17	241	11	1	270	3	5	13	0	21	682
05:15 PM	15	290	38	1	344	115	5	37	1	158	23	238	7	2	270	9	5	21	0	35	807
05:30 PM	7	304	42	7	360	121	4	48	2	175	20	268	12	0	300	6	3	8	0	17	852
05:45 PM	24	315	39	4	382	90	5	50	2	147	12	227	12	3	254	5	5	12	0	22	805
Total	54	1136	157	13	1360	415	15	162	5	597	72	974	42	6	1094	23	18	54	0	95	3146
06:00 PM	21	326	50	3	400	100	6	49	1	156	17	264	17	0	298	3	3	6	0	12	866
06:15 PM	12	301	39	11	363	84	7	16	4	111	12	212	13	1	238	4	2	13	4	23	735
06:30 PM	31	272	51	11	365	76	7	18	2	103	19	238	27	0	284	11	2	7	0	20	772
06:45 PM	44	241	31	6	322	73	7	24	0	104	12	216	25	2	255	5	3	9	2	19	700
Total	108	1140	171	31	1450	333	27	107	7	474	60	930	82	3	1075	23	10	35	6	74	3073
Grand Total	178	3021	484	57	3740	1059	54	366	23	1502	213	2679	169	10	3071	64	37	136	7	244	8557
Apprch %	4.8	80.8	12.9	1.5		70.5	3.6	24.4	1.5		6.9	87.2	5.5	0.3		26.2	15.2	55.7	2.9		
Total %	2.1	35.3	5.7	0.7	43.7	12.4	0.6	4.3	0.3	17.6	2.5	31.3	2	0.1	35.9	0.7	0.4	1.6	0.1	2.9	

Start Time	N WOLFE RD Southbound				VALLCO PKWY Westbound				N WOLFE RD Northbound				DRIVEWAY Eastbound				Int. Total
	Right	Thru	Left	App. Total	Right	Thru	Left	App. Total	Right	Thru	Left	App. Total	Right	Thru	Left	App. Total	
Peak Hour Analysis From 04:00 PM to 06:45 PM - Peak 1 of 1																	
Peak Hour for Entire Intersection Begins at 05:15 PM																	
05:15 PM	15	290	38	343	115	5	37	157	23	238	7	268	9	5	21	35	803
05:30 PM	7	304	42	353	121	4	48	173	20	268	12	300	6	3	8	17	843
05:45 PM	24	315	39	378	90	5	50	145	12	227	12	251	5	5	12	22	796
06:00 PM	21	326	50	397	100	6	49	155	17	264	17	298	3	3	6	12	862
Total Volume	67	1235	169	1471	426	20	184	630	72	997	48	1117	23	16	47	86	3304
% App. Total	4.6	84	11.5		67.6	3.2	29.2		6.4	89.3	4.3		26.7	18.6	54.7		
PHF	.698	.947	.845	.926	.880	.833	.920	.910	.783	.930	.706	.931	.639	.800	.560	.614	.958

Traffic Data Service

Campbell, CA
 (408) 377-2988
tdsbay@cs.com

File Name : 14PM FINAL
 Site Code : 00000014
 Start Date : 3/31/2015
 Page No : 2

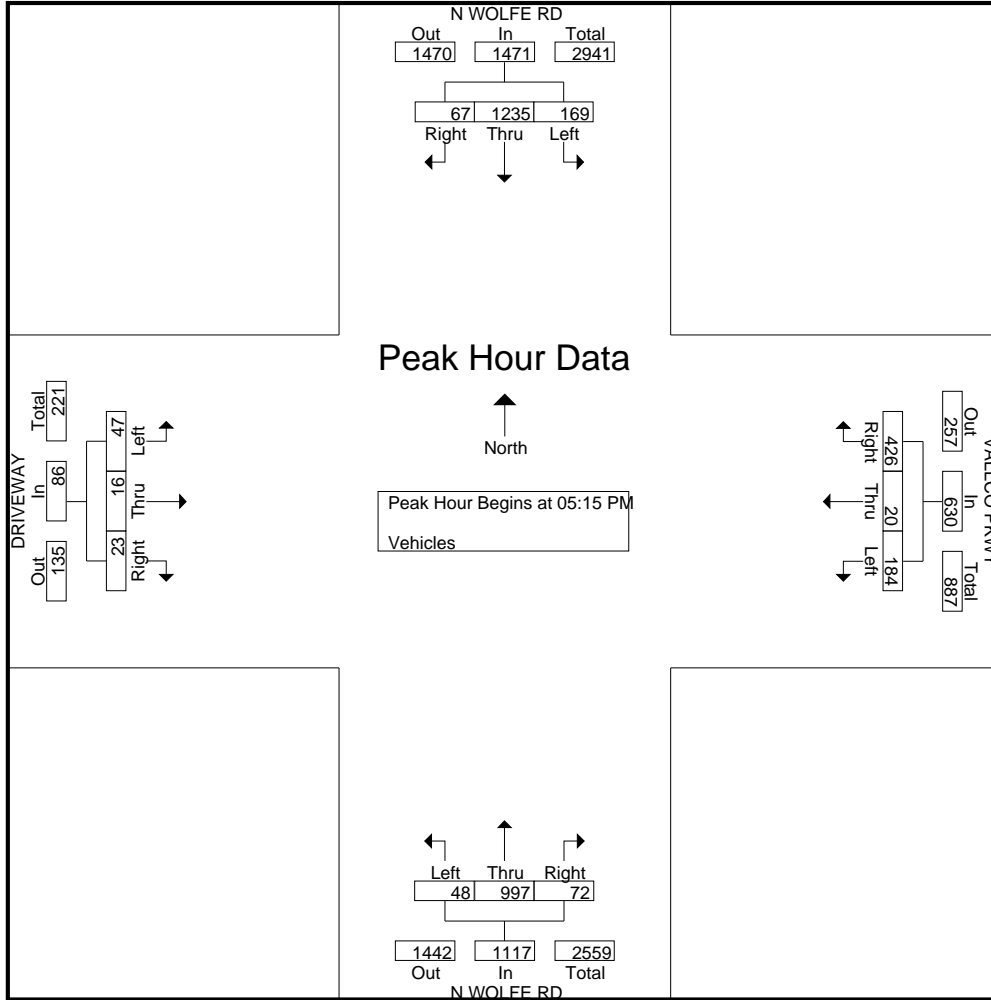

Traffic Data Service

Campbell, CA
 (408) 377-2988
 tdsbay@cs.com

File Name : 15AM FINAL
 Site Code : 00000015
 Start Date : 3/26/2015
 Page No : 1

Groups Printed- Vehicles

Start Time	N WOLFE RD Southbound					STEVENS CREEK BLVD Westbound					MILLER AVE Northbound					STEVENS CREEK BLVD Eastbound					Int. Total
	Right	Thru	Left	Peds	App. Total	Right	Thru	Left	Peds	App. Total	Right	Thru	Left	Peds	App. Total	Right	Thru	Left	Peds	App. Total	
07:00 AM	39	23	27	3	92	10	86	7	0	103	5	72	16	3	96	14	59	28	1	102	393
07:15 AM	50	34	45	1	130	63	140	32	0	235	13	97	43	8	161	31	135	28	3	197	723
07:30 AM	51	63	34	0	148	50	206	37	0	293	59	204	43	5	311	17	115	41	3	176	928
07:45 AM	68	55	40	5	168	35	200	10	0	245	27	179	62	3	271	19	67	50	2	138	822
Total	208	175	146	9	538	158	632	86	0	876	104	552	164	19	839	81	376	147	9	613	2866
08:00 AM	85	51	20	1	157	30	228	22	0	280	14	224	52	6	296	23	106	50	3	182	915
08:15 AM	121	78	58	1	258	31	187	22	2	242	28	210	30	7	275	23	106	60	4	193	968
08:30 AM	126	44	56	1	227	34	244	18	6	302	40	271	59	8	378	16	157	94	2	269	1176
08:45 AM	139	68	68	3	278	34	288	21	10	353	38	230	60	13	341	15	137	96	0	248	1220
Total	471	241	202	6	920	129	947	83	18	1177	120	935	201	34	1290	77	506	300	9	892	4279
09:00 AM	125	29	45	5	204	48	286	20	4	358	16	147	62	16	241	12	141	116	3	272	1075
09:15 AM	113	43	52	6	214	21	184	10	1	216	26	138	37	6	207	11	118	58	5	192	829
09:30 AM	149	49	40	4	242	31	158	19	3	211	24	99	30	5	158	12	145	83	6	246	857
09:45 AM	141	53	51	10	255	24	167	15	10	216	16	94	49	5	164	11	106	65	5	187	822
Total	528	174	188	25	915	124	795	64	18	1001	82	478	178	32	770	46	510	322	19	897	3583
Grand Total	1207	590	536	40	2373	411	2374	233	36	3054	306	1965	543	85	2899	204	1392	769	37	2402	10728
Apprch %	50.9	24.9	22.6	1.7		13.5	77.7	7.6	1.2		10.6	67.8	18.7	2.9		8.5	58	32	1.5		
Total %	11.3	5.5	5	0.4	22.1	3.8	22.1	2.2	0.3	28.5	2.9	18.3	5.1	0.8	27	1.9	13	7.2	0.3	22.4	

Start Time	N WOLFE RD Southbound				STEVENS CREEK BLVD Westbound				MILLER AVE Northbound				STEVENS CREEK BLVD Eastbound				Int. Total
	Right	Thru	Left	App. Total	Right	Thru	Left	App. Total	Right	Thru	Left	App. Total	Right	Thru	Left	App. Total	
Peak Hour Analysis From 07:00 AM to 09:45 AM - Peak 1 of 1																	
Peak Hour for Entire Intersection Begins at 08:15 AM																	
08:15 AM	121	78	58	257	31	187	22	240	28	210	30	268	23	106	60	189	954
08:30 AM	126	44	56	226	34	244	18	296	40	271	59	370	16	157	94	267	1159
08:45 AM	139	68	68	275	34	288	21	343	38	230	60	328	15	137	96	248	1194
09:00 AM	125	29	45	199	48	286	20	354	16	147	62	225	12	141	116	269	1047
Total Volume	511	219	227	957	147	1005	81	1233	122	858	211	1191	66	541	366	973	4354
% App. Total	53.4	22.9	23.7		11.9	81.5	6.6		10.2	72	17.7		6.8	55.6	37.6		
PHF	.919	.702	.835	.870	.766	.872	.920	.871	.763	.792	.851	.805	.717	.861	.789	.904	.912

Traffic Data Service

Campbell, CA
 (408) 377-2988
 tdsbay@cs.com

File Name : 15AM FINAL
 Site Code : 00000015
 Start Date : 3/26/2015
 Page No : 2

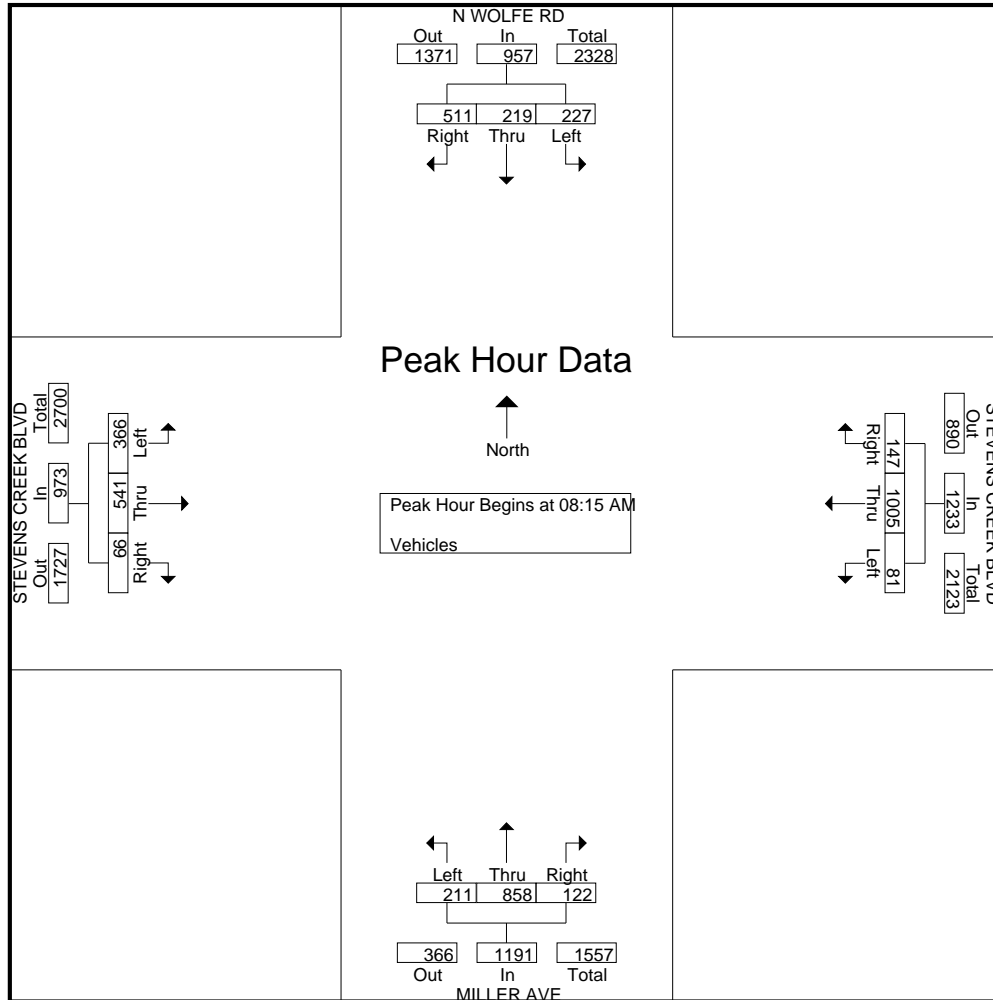

Traffic Data Service

Campbell, CA
 (408) 377-2988
 tdsbay@cs.com

File Name : 15PM FINAL
 Site Code : 00000015
 Start Date : 3/26/2015
 Page No : 1

Groups Printed- Vehicles

Start Time	N WOLFE RD Southbound					STEVENS CREEK BLVD Westbound					MILLER AVE Northbound					STEVENS CREEK BLVD Eastbound					Int. Total
	Right	Thru	Left	Peds	App. Total	Right	Thru	Left	Peds	App. Total	Right	Thru	Left	Peds	App. Total	Right	Thru	Left	Peds	App. Total	
04:00 PM	74	116	59	10	259	37	152	22	6	217	22	78	41	14	155	50	275	104	3	432	1063
04:15 PM	79	109	49	6	243	30	177	26	7	240	22	68	36	4	130	42	265	97	2	406	1019
04:30 PM	72	89	55	9	225	46	128	38	7	219	19	61	37	7	124	55	273	94	3	425	993
04:45 PM	82	123	53	2	260	43	214	43	2	302	14	41	30	6	91	54	288	90	1	433	1086
Total	307	437	216	27	987	156	671	129	22	978	77	248	144	31	500	201	1101	385	9	1696	4161
05:00 PM	89	150	53	3	295	46	164	35	7	252	11	72	33	5	121	60	282	127	3	472	1140
05:15 PM	82	157	59	7	305	55	186	66	14	321	29	92	51	6	178	94	337	116	2	549	1353
05:30 PM	102	187	73	10	372	57	173	61	5	296	30	119	51	4	204	65	343	119	2	529	1401
05:45 PM	101	193	76	6	376	49	222	74	5	350	20	62	55	4	141	79	297	93	1	470	1337
Total	374	687	261	26	1348	207	745	236	31	1219	90	345	190	19	644	298	1259	455	8	2020	5231
06:00 PM	131	198	80	0	409	39	201	61	1	302	19	79	49	0	147	34	323	149	0	506	1364
06:15 PM	96	175	60	0	331	40	222	57	3	322	15	75	58	4	152	32	321	118	0	471	1276
06:30 PM	85	188	74	0	347	46	153	43	6	248	16	76	28	7	127	48	286	127	0	461	1183
06:45 PM	95	186	51	0	332	36	160	64	9	269	13	69	0	5	87	57	219	98	0	374	1062
Total	407	747	265	0	1419	161	736	225	19	1141	63	299	135	16	513	171	1149	492	0	1812	4885
Grand Total	1088	1871	742	53	3754	524	2152	590	72	3338	230	892	469	66	1657	670	3509	1332	17	5528	14277
Apprch %	29	49.8	19.8	1.4		15.7	64.5	17.7	2.2		13.9	53.8	28.3	4		12.1	63.5	24.1	0.3		
Total %	7.6	13.1	5.2	0.4	26.3	3.7	15.1	4.1	0.5	23.4	1.6	6.2	3.3	0.5	11.6	4.7	24.6	9.3	0.1	38.7	

Start Time	N WOLFE RD Southbound				STEVENS CREEK BLVD Westbound				MILLER AVE Northbound				STEVENS CREEK BLVD Eastbound				Int. Total
	Right	Thru	Left	App. Total	Right	Thru	Left	App. Total	Right	Thru	Left	App. Total	Right	Thru	Left	App. Total	
Peak Hour Analysis From 04:00 PM to 06:45 PM - Peak 1 of 1																	
Peak Hour for Entire Intersection Begins at 05:15 PM																	
05:15 PM	82	157	59	298	55	186	66	307	29	92	51	172	94	337	116	547	1324
05:30 PM	102	187	73	362	57	173	61	291	30	119	51	200	65	343	119	527	1380
05:45 PM	101	193	76	370	49	222	74	345	20	62	55	137	79	297	93	469	1321
06:00 PM	131	198	80	409	39	201	61	301	19	79	49	147	34	323	149	506	1363
Total Volume	416	735	288	1439	200	782	262	1244	98	352	206	656	272	1300	477	2049	5388
% App. Total	28.9	51.1	20		16.1	62.9	21.1		14.9	53.7	31.4		13.3	63.4	23.3		
PHF	.794	.928	.900	.880	.877	.881	.885	.901	.817	.739	.936	.820	.723	.948	.800	.936	.976

Traffic Data Service

Campbell, CA
(408) 377-2988
idsbay@cs.com

File Name : 15PM FINAL

Site Code : 00000015

Start Date : 3/26/2015

Page No : 2

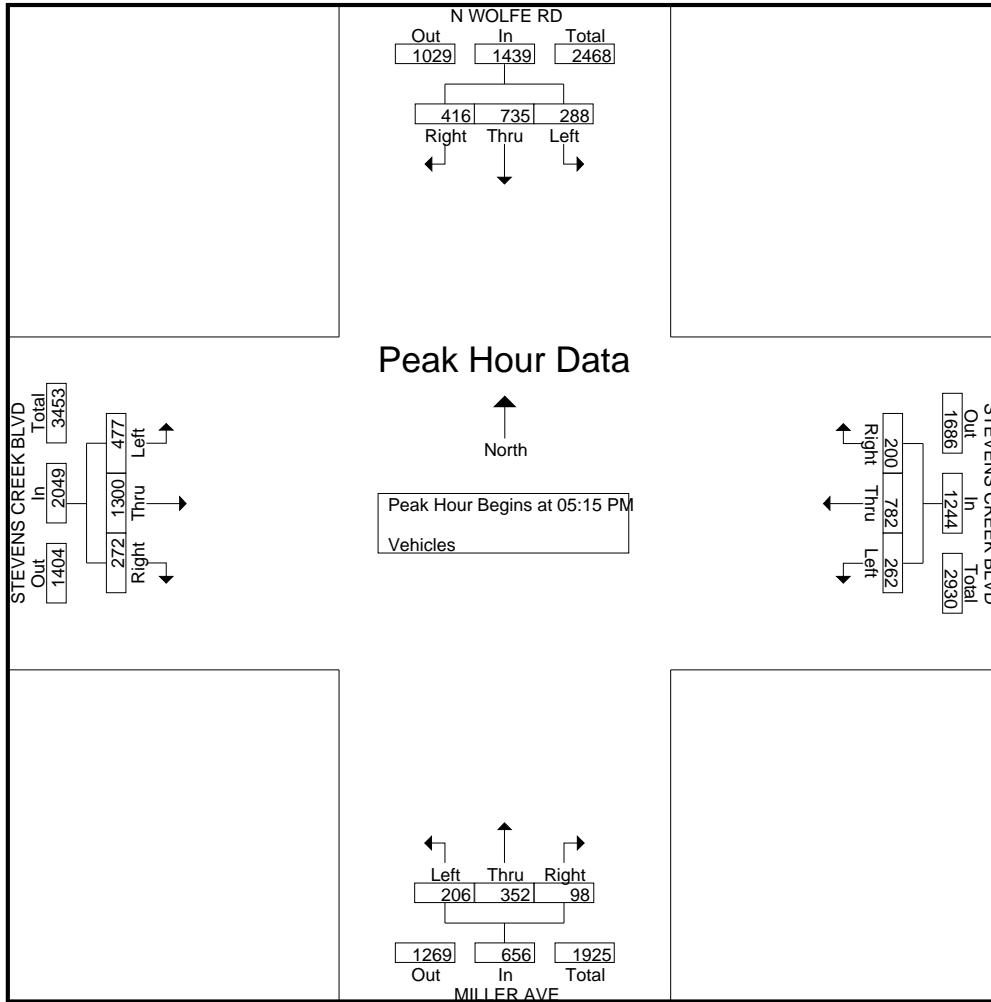

Traffic Data Service

Campbell, CA
 (408) 377-2988
 tdsbay@cs.com

File Name : 6AM FINAL
 Site Code : 00000006
 Start Date : 3/26/2015
 Page No : 1

Groups Printed- Vehicles

Start Time	N DE ANZA BLVD Southbound					STEVENS CREEK BLVD Westbound					S DE ANZA BLVD Northbound					STEVENS CREEK BLVD Eastbound					Int. Total
	Right	Thru	Left	Peds	App. Total	Right	Thru	Left	Peds	App. Total	Right	Thru	Left	Peds	App. Total	Right	Thru	Left	Peds	App. Total	
07:00 AM	22	65	37	4	128	20	43	24	10	97	24	197	36	2	259	10	19	25	3	57	541
07:15 AM	34	85	36	1	156	34	76	32	0	142	22	267	69	6	364	13	36	22	7	78	740
07:30 AM	16	81	53	3	153	44	89	44	7	184	33	347	89	4	473	19	39	41	1	100	910
07:45 AM	33	139	70	2	244	62	133	49	2	246	29	426	106	14	575	24	44	48	1	117	1182
Total	105	370	196	10	681	160	341	149	19	669	108	1237	300	26	1671	66	138	136	12	352	3373
08:00 AM	47	185	104	10	346	61	133	55	7	256	38	447	111	7	603	21	70	50	6	147	1352
08:15 AM	54	187	89	7	337	53	166	78	9	306	40	393	119	11	563	24	74	43	3	144	1350
08:30 AM	44	127	102	11	284	84	155	56	10	305	56	509	162	12	739	18	85	51	6	160	1488
08:45 AM	63	159	103	8	333	94	180	53	21	348	52	460	151	16	679	35	91	47	2	175	1535
Total	208	658	398	36	1300	292	634	242	47	1215	186	1809	543	46	2584	98	320	191	17	626	5725
09:00 AM	65	101	110	11	287	92	222	61	8	383	47	366	132	12	557	37	129	48	5	219	1446
09:15 AM	33	135	96	8	272	76	143	51	4	274	54	341	133	18	546	37	97	52	0	186	1278
09:30 AM	35	137	106	10	288	72	146	37	16	271	36	275	110	7	428	41	136	51	12	240	1227
09:45 AM	53	155	95	21	324	62	111	61	10	244	39	246	101	11	397	48	113	45	6	212	1177
Total	186	528	407	50	1171	302	622	210	38	1172	176	1228	476	48	1928	163	475	196	23	857	5128
Grand Total	499	1556	1001	96	3152	754	1597	601	104	3056	470	4274	1319	120	6183	327	933	523	52	1835	14226
Apprch %	15.8	49.4	31.8	3		24.7	52.3	19.7	3.4		7.6	69.1	21.3	1.9		17.8	50.8	28.5	2.8		
Total %	3.5	10.9	7	0.7	22.2	5.3	11.2	4.2	0.7	21.5	3.3	30	9.3	0.8	43.5	2.3	6.6	3.7	0.4	12.9	

Start Time	N DE ANZA BLVD Southbound				STEVENS CREEK BLVD Westbound				S DE ANZA BLVD Northbound				STEVENS CREEK BLVD Eastbound				Int. Total
	Right	Thru	Left	App. Total	Right	Thru	Left	App. Total	Right	Thru	Left	App. Total	Right	Thru	Left	App. Total	
Peak Hour Analysis From 07:00 AM to 09:45 AM - Peak 1 of 1																	
Peak Hour for Entire Intersection Begins at 08:15 AM																	
08:15 AM	54	187	89	330	53	166	78	297	40	393	119	552	24	74	43	141	1320
08:30 AM	44	127	102	273	84	155	56	295	56	509	162	727	18	85	51	154	1449
08:45 AM	63	159	103	325	94	180	53	327	52	460	151	663	35	91	47	173	1488
09:00 AM	65	101	110	276	92	222	61	375	47	366	132	545	37	129	48	214	1410
Total Volume	226	574	404	1204	323	723	248	1294	195	1728	564	2487	114	379	189	682	5667
% App. Total	18.8	47.7	33.6		25	55.9	19.2		7.8	69.5	22.7		16.7	55.6	27.7		
PHF	.869	.767	.918	.912	.859	.814	.795	.863	.871	.849	.870	.855	.770	.734	.926	.797	.952

Traffic Data Service

Campbell, CA
(408) 377-2988
idsbay@cs.com

File Name : 6AM FINAL

Site Code : 00000006

Start Date : 3/26/2015

Page No : 2

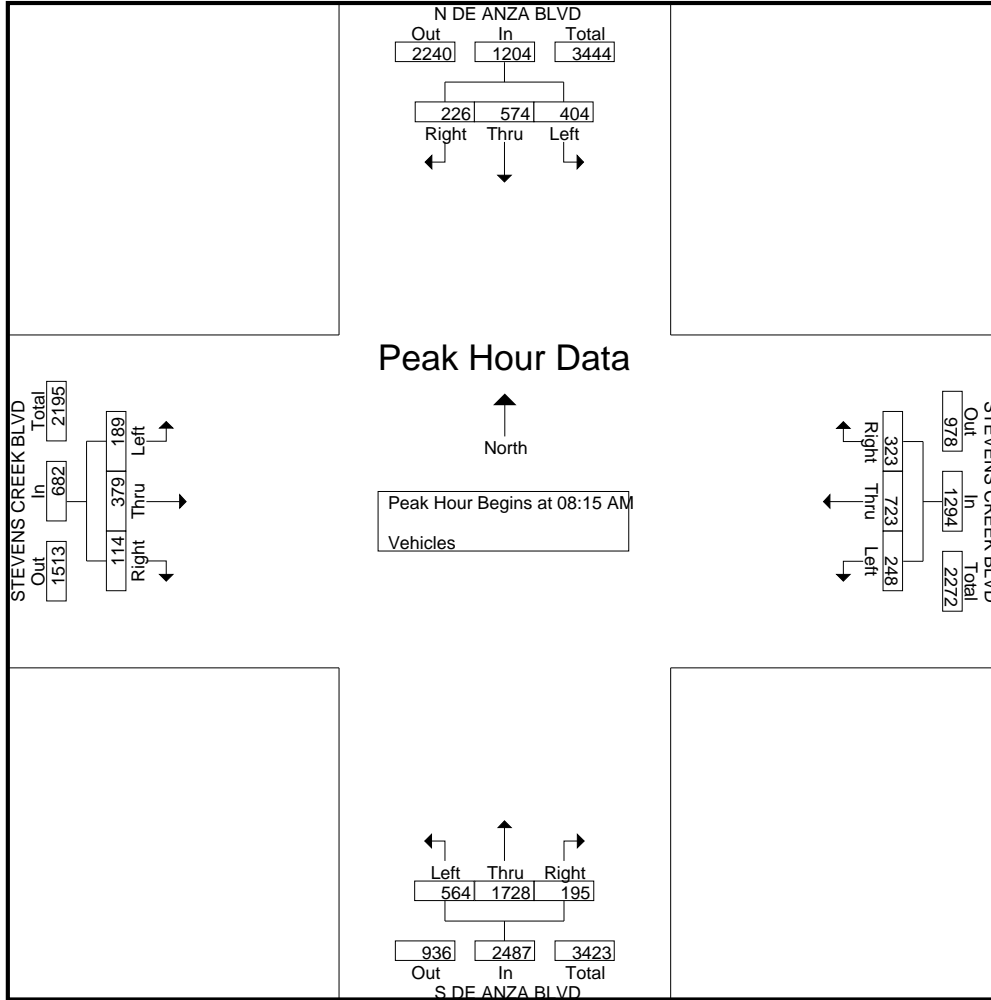

Traffic Data Service

Campbell, CA
 (408) 377-2988
 tdsbay@cs.com

File Name : 6PM FINAL
 Site Code : 00000006
 Start Date : 3/26/2015
 Page No : 1

Groups Printed- Vehicles

Start Time	N DE ANZA BLVD Southbound					STEVENS CREEK BLVD Westbound					S DE ANZA BLVD Northbound					STEVENS CREEK BLVD Eastbound					Int. Total
	Right	Thru	Left	Peds	App. Total	Right	Thru	Left	Peds	App. Total	Right	Thru	Left	Peds	App. Total	Right	Thru	Left	Peds	App. Total	
04:00 PM	70	361	114	11	556	52	138	58	0	248	58	196	120	27	401	106	199	61	12	378	1583
04:15 PM	59	314	97	10	480	44	149	96	0	289	60	177	87	15	339	109	213	57	1	380	1488
04:30 PM	62	370	136	4	572	65	111	69	0	245	52	157	109	16	334	109	210	44	6	369	1520
04:45 PM	51	426	101	8	586	54	123	86	0	263	57	179	96	14	346	93	217	59	9	378	1573
Total	242	1471	448	33	2194	215	521	309	0	1045	227	709	412	72	1420	417	839	221	28	1505	6164
05:00 PM	62	425	137	7	631	67	153	87	7	314	61	199	113	10	383	119	252	42	6	419	1747
05:15 PM	67	529	124	7	727	57	121	75	7	260	62	244	119	9	434	105	248	48	6	407	1828
05:30 PM	57	462	126	12	657	77	154	104	15	350	64	194	94	16	368	118	274	55	12	459	1834
05:45 PM	73	506	143	10	732	58	159	93	7	317	80	204	126	18	428	103	220	52	11	386	1863
Total	259	1922	530	36	2747	259	587	359	36	1241	267	841	452	53	1613	445	994	197	35	1671	7272
06:00 PM	89	432	114	10	645	72	161	93	0	326	71	190	134	11	406	90	257	45	5	397	1774
06:15 PM	70	444	138	3	655	63	162	92	0	317	62	237	116	10	425	129	234	56	0	419	1816
06:30 PM	45	488	121	9	663	44	146	81	0	271	76	178	96	9	359	101	188	43	12	344	1637
06:45 PM	77	390	140	4	611	53	145	77	0	275	47	169	100	5	321	99	189	54	9	351	1558
Total	281	1754	513	26	2574	232	614	343	0	1189	256	774	446	35	1511	419	868	198	26	1511	6785
Grand Total	782	5147	1491	95	7515	706	1722	1011	36	3475	750	2324	1310	160	4544	1281	2701	616	89	4687	20221
Apprch %	10.4	68.5	19.8	1.3		20.3	49.6	29.1	1		16.5	51.1	28.8	3.5		27.3	57.6	13.1	1.9		
Total %	3.9	25.5	7.4	0.5	37.2	3.5	8.5	5	0.2	17.2	3.7	11.5	6.5	0.8	22.5	6.3	13.4	3	0.4	23.2	

Start Time	N DE ANZA BLVD Southbound				STEVENS CREEK BLVD Westbound				S DE ANZA BLVD Northbound				STEVENS CREEK BLVD Eastbound				Int. Total				
	Right	Thru	Left	App. Total	Right	Thru	Left	App. Total	Right	Thru	Left	App. Total	Right	Thru	Left	App. Total					
Peak Hour Analysis From 04:00 PM to 06:45 PM - Peak 1 of 1																					
Peak Hour for Entire Intersection Begins at 05:30 PM																					
05:30 PM	57	462	126	645	77	154	104	335	64	194	94	352	118	274	55	447	1779				
05:45 PM	73	506	143	722	58	159	93	310	80	204	126	410	103	220	52	375	1817				
06:00 PM	89	432	114	635	72	161	93	326	71	190	134	395	90	257	45	392	1748				
06:15 PM	70	444	138	652	63	162	92	317	62	237	116	415	129	234	56	419	1803				
Total Volume	289	1844	521	2654	270	636	382	1288	277	825	470	1572	440	985	208	1633	7147				
% App. Total	10.9	69.5	19.6		21	49.4	29.7		17.6	52.5	29.9		26.9	60.3	12.7						
PHF	.812	.911	.911	.919	.877	.981	.918	.961	.866	.870	.877	.947	.853	.899	.929	.913	.983				

Traffic Data Service

Campbell, CA
 (408) 377-2988
 tdsbay@cs.com

File Name : 6PM FINAL
 Site Code : 00000006
 Start Date : 3/26/2015
 Page No : 2

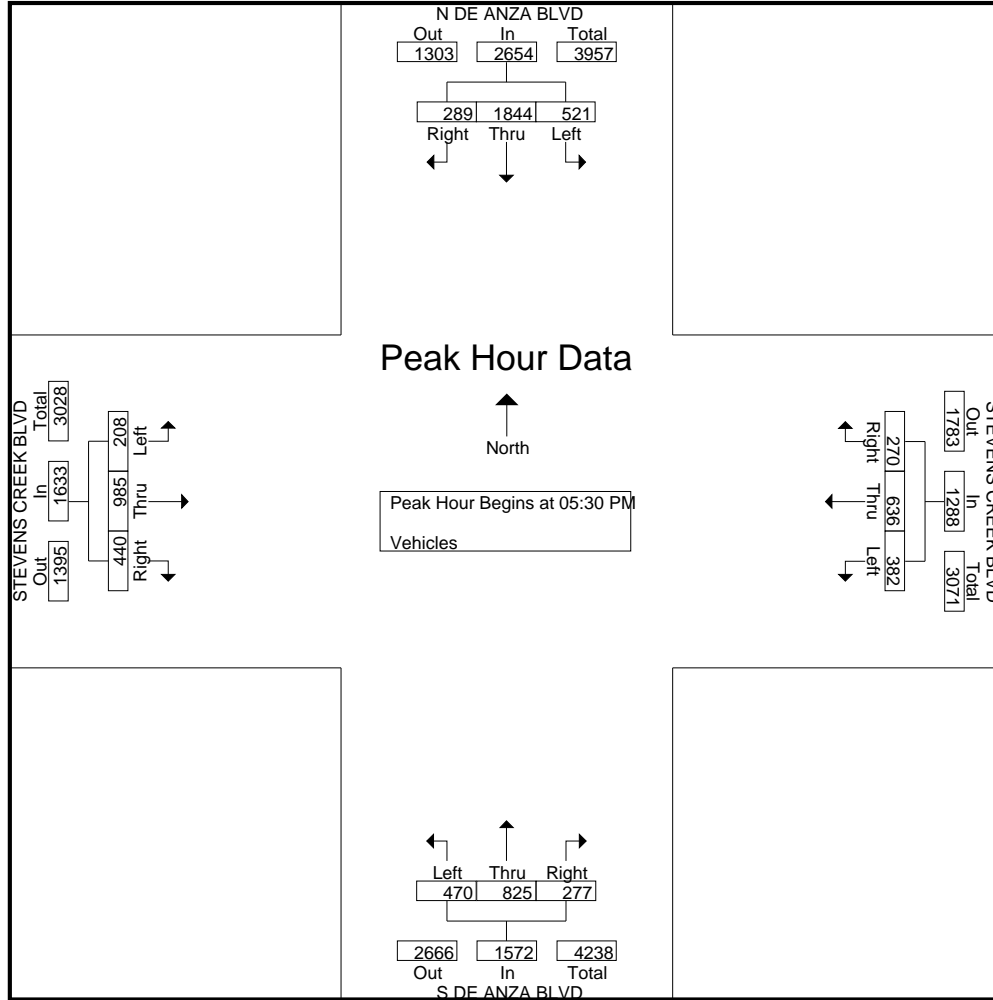

Traffic Data Service

Campbell, CA
(408) 377-2988
tdsbay@cs.com

File Name : 23AM FINAL
Site Code : 00000023
Start Date : 5/5/2011
Page No : 1

Groups Printed- Vehicles

Start Time	QUAIL AVE Southbound					E. HOMESTEAD RD Westbound					TANTAU AVE Northbound					E. HOMESTEAD RD Eastbound					Int. Total
	Right	Thru	Left	Peds	App. Total	Right	Thru	Left	Peds	App. Total	Right	Thru	Left	Peds	App. Total	Right	Thru	Left	Peds	App. Total	
06:30 AM	5	5	8	1	19	0	32	6	0	38	9	6	5	0	20	8	32	8	0	48	125
06:45 AM	2	6	6	2	16	2	69	2	0	73	15	8	6	0	29	16	46	6	0	68	186
Total	7	11	14	3	35	2	101	8	0	111	24	14	11	0	49	24	78	14	0	116	311
07:00 AM	12	3	8	0	23	2	72	3	0	77	16	6	2	0	24	25	48	12	0	85	209
07:15 AM	17	2	11	2	32	3	102	15	0	120	26	8	6	0	40	28	63	16	0	107	299
07:30 AM	22	8	15	0	45	5	126	28	1	160	23	6	10	0	39	32	89	8	0	129	373
07:45 AM	16	15	12	0	43	9	182	32	0	223	25	10	15	0	50	25	125	11	0	161	477
Total	67	28	46	2	143	19	482	78	1	580	90	30	33	0	153	110	325	47	0	482	1358
08:00 AM	16	26	16	1	59	15	225	52	2	294	25	15	16	0	56	53	136	10	1	200	609
08:15 AM	25	25	23	2	75	9	183	43	0	235	13	16	11	2	42	52	152	15	2	221	573
08:30 AM	26	21	25	1	73	12	182	42	1	237	12	25	8	0	45	37	136	16	0	189	544
08:45 AM	25	23	32	1	81	15	192	41	1	249	14	12	6	2	34	52	125	8	1	186	550
Total	92	95	96	5	288	51	782	178	4	1015	64	68	41	4	177	194	549	49	4	796	2276
09:00 AM	13	25	25	0	63	15	163	35	2	215	15	16	8	0	39	46	124	6	1	177	494
09:15 AM	18	16	26	0	60	13	158	52	1	224	26	10	6	1	43	34	132	8	0	174	501
Grand Total	197	175	207	10	589	100	1686	351	8	2145	219	138	99	5	461	408	1208	124	5	1745	4940
Apprch %	33.4	29.7	35.1	1.7		4.7	78.6	16.4	0.4		47.5	29.9	21.5	1.1		23.4	69.2	7.1	0.3		
Total %	4	3.5	4.2	0.2	11.9	2	34.1	7.1	0.2	43.4	4.4	2.8	2	0.1	9.3	8.3	24.5	2.5	0.1	35.3	

Start Time	QUAIL AVE Southbound					E. HOMESTEAD RD Westbound					TANTAU AVE Northbound					E. HOMESTEAD RD Eastbound					Int. Total
	Right	Thru	Left	Peds	App. Total	Right	Thru	Left	Peds	App. Total	Right	Thru	Left	Peds	App. Total	Right	Thru	Left	Peds	App. Total	
Peak Hour Analysis From 06:30 AM to 09:15 AM - Peak 1 of 1																					
Peak Hour for Entire Intersection Begins at 08:00 AM																					
08:00 AM	16	26	16	1	59	15	225	52	2	294	25	15	16	0	56	53	136	10	1	200	609
08:15 AM	25	25	23	2	75	9	183	43	0	235	13	16	11	2	42	52	152	15	2	221	573
08:30 AM	26	21	25	1	73	12	182	42	1	237	12	25	8	0	45	37	136	16	0	189	544
08:45 AM	25	23	32	1	81	15	192	41	1	249	14	12	6	2	34	52	125	8	1	186	550
Total Volume	92	95	96	5	288	51	782	178	4	1015	64	68	41	4	177	194	549	49	4	796	2276
% App. Total	31.9	33	33.3	1.7		5	77	17.5	0.4		36.2	38.4	23.2	2.3		24.4	69	6.2	0.5		
PHF	.885	.913	.750	.625	.889	.850	.869	.856	.500	.863	.640	.680	.641	.500	.790	.915	.903	.766	.500	.900	.934

Traffic Data Service

Campbell, CA
 (408) 377-2988
 tdsbay@cs.com

File Name : 23AM FINAL
 Site Code : 00000023
 Start Date : 5/5/2011
 Page No : 2

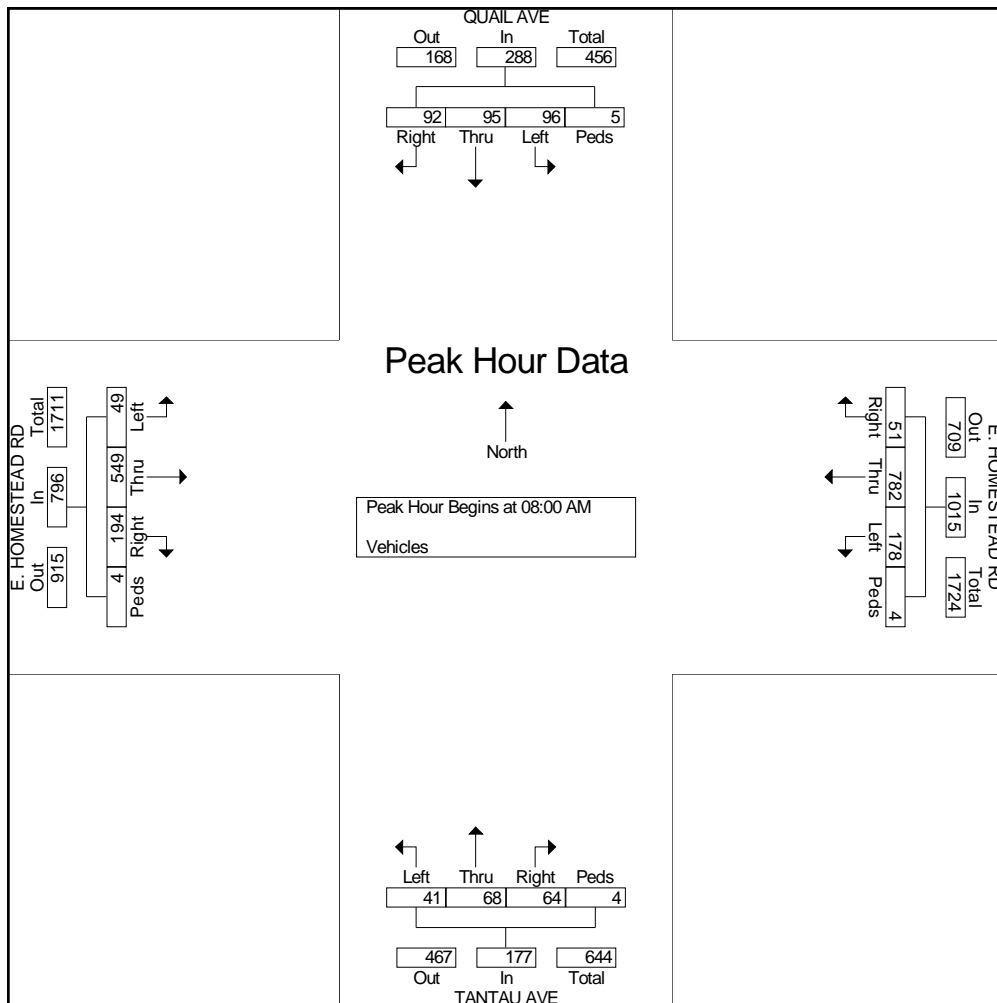

Traffic Data Service

Campbell, CA
(408) 377-2988
tdsbay@cs.com

File Name : 23PM FINAL
Site Code : 00000023
Start Date : 5/5/2011
Page No : 1

Groups Printed- Vehicles

Start Time	QUAIL AVE Southbound					E. HOMESTEAD RD Westbound					TANTAU AVE Northbound					E. HOMESTEAD RD Eastbound					Int. Total
	Right	Thru	Left	Peds	App. Total	Right	Thru	Left	Peds	App. Total	Right	Thru	Left	Peds	App. Total	Right	Thru	Left	Peds	App. Total	
04:00 PM	9	7	5	0	21	2	186	17	0	205	23	7	23	0	53	28	151	7	3	189	468
04:15 PM	12	5	5	0	22	8	153	19	1	181	19	12	13	0	44	22	180	10	0	212	459
04:30 PM	11	7	4	0	22	2	172	15	5	194	34	10	16	4	64	23	161	7	0	191	471
04:45 PM	7	6	4	0	17	6	194	32	0	232	30	10	20	1	61	31	204	6	0	241	551
Total	39	25	18	0	82	18	705	83	6	812	106	39	72	5	222	104	696	30	3	833	1949
05:00 PM	2	18	4	0	24	12	223	48	1	284	37	18	30	0	85	21	195	9	0	225	618
05:15 PM	14	18	7	1	40	7	213	40	0	260	39	16	22	1	78	40	209	15	0	264	642
05:30 PM	18	30	8	0	56	4	195	34	0	233	53	28	27	4	112	28	197	9	1	235	636
05:45 PM	19	28	15	0	62	1	263	24	0	288	43	19	29	2	93	27	190	20	1	238	681
Total	53	94	34	1	182	24	894	146	1	1065	172	81	108	7	368	116	791	53	2	962	2577
06:00 PM	24	31	11	1	67	6	233	35	0	274	38	17	20	1	76	23	209	6	0	238	655
06:15 PM	11	20	15	0	46	8	179	23	2	212	40	13	23	2	78	22	235	5	0	262	598
06:30 PM	6	8	11	1	26	4	216	23	0	243	34	13	20	0	67	28	209	8	0	245	581
06:45 PM	6	7	5	1	19	5	191	21	3	220	38	13	14	1	66	14	144	7	4	169	474
Total	47	66	42	3	158	23	819	102	5	949	150	56	77	4	287	87	797	26	4	914	2308
Grand Total	139	185	94	4	422	65	2418	331	12	2826	428	176	257	16	877	307	2284	109	9	2709	6834
Apprch %	32.9	43.8	22.3	0.9		2.3	85.6	11.7	0.4		48.8	20.1	29.3	1.8		11.3	84.3	4	0.3		
Total %	2	2.7	1.4	0.1	6.2	1	35.4	4.8	0.2	41.4	6.3	2.6	3.8	0.2	12.8	4.5	33.4	1.6	0.1	39.6	

Start Time	QUAIL AVE Southbound					E. HOMESTEAD RD Westbound					TANTAU AVE Northbound					E. HOMESTEAD RD Eastbound					Int. Total
	Right	Thru	Left	Peds	App. Total	Right	Thru	Left	Peds	App. Total	Right	Thru	Left	Peds	App. Total	Right	Thru	Left	Peds	App. Total	
Peak Hour Analysis From 04:00 PM to 06:45 PM - Peak 1 of 1																					
Peak Hour for Entire Intersection Begins at 05:15 PM																					
05:15 PM	14	18	7	1	40	7	213	40	0	260	39	16	22	1	78	40	209	15	0	264	642
05:30 PM	18	30	8	0	56	4	195	34	0	233	53	28	27	4	112	28	197	9	1	235	636
05:45 PM	19	28	15	0	62	1	263	24	0	288	43	19	29	2	93	27	190	20	1	238	681
06:00 PM	24	31	11	1	67	6	233	35	0	274	38	17	20	1	76	23	209	6	0	238	655
Total Volume	75	107	41	2	225	18	904	133	0	1055	173	80	98	8	359	118	805	50	2	975	2614
% App. Total	33.3	47.6	18.2	0.9		1.7	85.7	12.6	0		48.2	22.3	27.3	2.2		12.1	82.6	5.1	0.2		
PHF	.781	.863	.683	.500	.840	.643	.859	.831	.000	.916	.816	.714	.845	.500	.801	.738	.963	.625	.500	.923	.960

Traffic Data Service

Campbell, CA
 (408) 377-2988
 tdsbay@cs.com

File Name : 23PM FINAL
 Site Code : 00000023
 Start Date : 5/5/2011
 Page No : 2

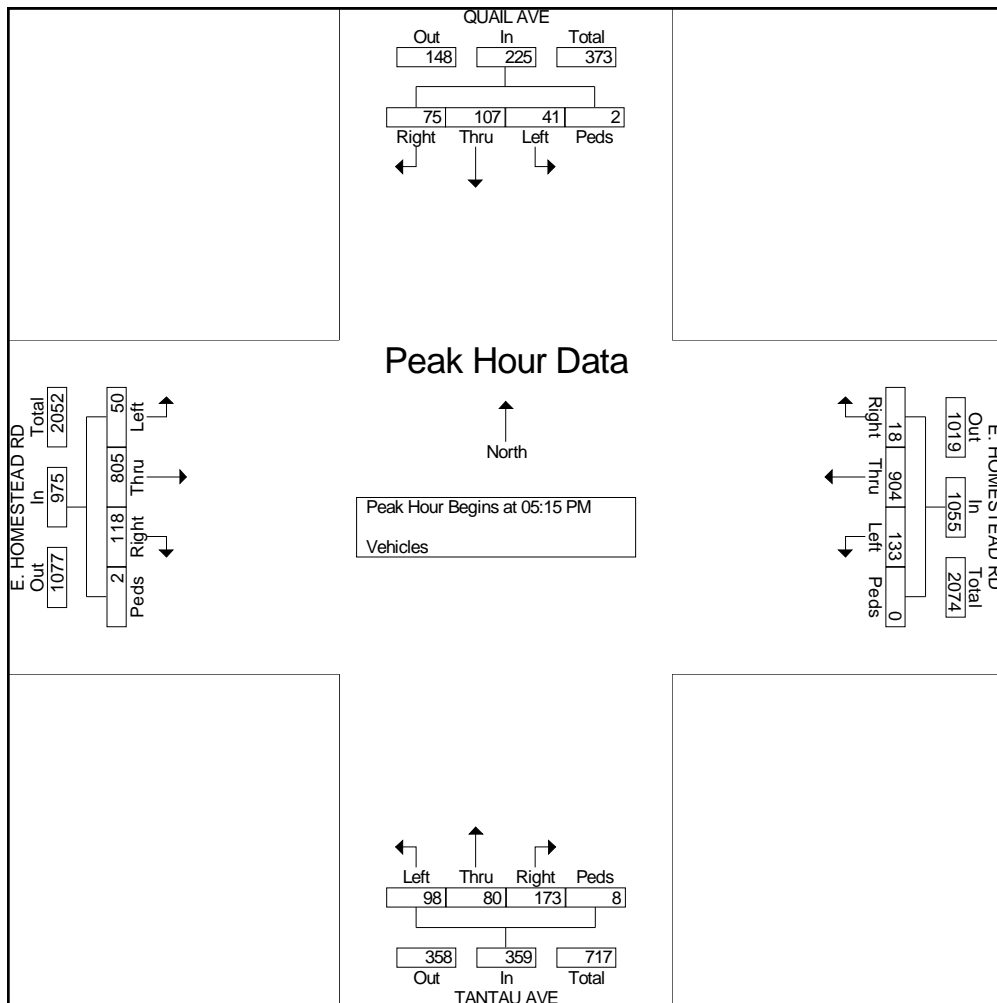

Traffic Data Service

Campbell, CA
(408) 377-2988
tdsbay@cs.com

File Name : 25AM FINAL
Site Code : 00000025
Start Date : 6/1/2011
Page No : 1

Groups Printed- Vehicles

Start Time	TANTAU AVE Southbound					Westbound					TANTAU AVE Northbound					VALLCO PKWY Eastbound					Int. Total
	Right	Thru	Left	Peds	App. Total	Right	Thru	Left	Peds	App. Total	Right	Thru	Left	Peds	App. Total	Right	Thru	Left	Peds	App. Total	
06:30 AM	4	5	0	1	10	0	0	0	0	0	0	16	8	0	24	1	0	2	0	3	37
06:45 AM	7	8	0	1	16	0	0	0	0	0	1	27	9	0	37	1	0	5	2	8	61
Total	11	13	0	2	26	0	0	0	0	0	1	43	17	0	61	2	0	7	2	11	98
07:00 AM	5	15	0	0	20	0	0	0	0	0	3	29	9	0	41	1	0	5	2	8	69
07:15 AM	8	13	0	0	21	0	0	0	0	0	2	40	8	0	50	3	0	3	0	6	77
07:30 AM	11	18	0	0	29	0	0	0	0	0	0	62	27	0	89	3	0	6	0	9	127
07:45 AM	14	24	1	0	39	0	0	0	0	0	3	77	19	1	100	3	2	10	0	15	154
Total	38	70	1	0	109	0	0	0	0	0	8	208	63	1	280	10	2	24	2	38	427
08:00 AM	20	52	0	0	72	0	1	0	1	2	2	70	22	0	94	3	0	6	2	11	179
08:15 AM	51	50	0	0	101	0	0	0	4	4	3	99	31	2	135	5	2	21	0	28	268
08:30 AM	28	62	0	1	91	0	0	2	1	3	2	127	30	3	162	3	4	28	0	35	291
08:45 AM	77	83	1	2	163	0	0	0	1	1	3	140	42	2	187	4	4	35	1	44	395
Total	176	247	1	3	427	0	1	2	7	10	10	436	125	7	578	15	10	90	3	118	1133
09:00 AM	47	39	0	2	88	1	0	0	2	3	2	156	33	2	193	7	3	37	2	49	333
09:15 AM	39	42	0	0	81	1	0	0	4	5	1	107	36	0	144	2	1	27	0	30	260
Grand Total	311	411	2	7	731	2	1	2	13	18	22	950	274	10	1256	36	16	185	9	246	2251
Apprch %	42.5	56.2	0.3	1		11.1	5.6	11.1	72.2		1.8	75.6	21.8	0.8		14.6	6.5	75.2	3.7		
Total %	13.8	18.3	0.1	0.3	32.5	0.1	0	0.1	0.6	0.8	1	42.2	12.2	0.4	55.8	1.6	0.7	8.2	0.4	10.9	

Start Time	TANTAU AVE Southbound					Westbound					TANTAU AVE Northbound					VALLCO PKWY Eastbound					Int. Total
	Right	Thru	Left	Peds	App. Total	Right	Thru	Left	Peds	App. Total	Right	Thru	Left	Peds	App. Total	Right	Thru	Left	Peds	App. Total	
Peak Hour Analysis From 06:30 AM to 09:15 AM - Peak 1 of 1																					
Peak Hour for Entire Intersection Begins at 08:15 AM																					
08:15 AM	51	50	0	0	101	0	0	0	4	4	3	99	31	2	135	5	2	21	0	28	268
08:30 AM	28	62	0	1	91	0	0	2	1	3	2	127	30	3	162	3	4	28	0	35	291
08:45 AM	77	83	1	2	163	0	0	0	1	1	3	140	42	2	187	4	4	35	1	44	395
09:00 AM	47	39	0	2	88	1	0	0	2	3	2	156	33	2	193	7	3	37	2	49	333
Total Volume	203	234	1	5	443	1	0	2	8	11	10	522	136	9	677	19	13	121	3	156	1287
% App. Total	45.8	52.8	0.2	1.1		9.1	0	18.2	72.7		1.5	77.1	20.1	1.3		12.2	8.3	77.6	1.9		
PHF	.659	.705	.250	.625	.679	.250	.000	.250	.500	.688	.833	.837	.810	.750	.877	.679	.813	.818	.375	.796	.815

Traffic Data Service

Campbell, CA
 (408) 377-2988
 tdsbay@cs.com

File Name : 25AM FINAL
 Site Code : 00000025
 Start Date : 6/1/2011
 Page No : 2

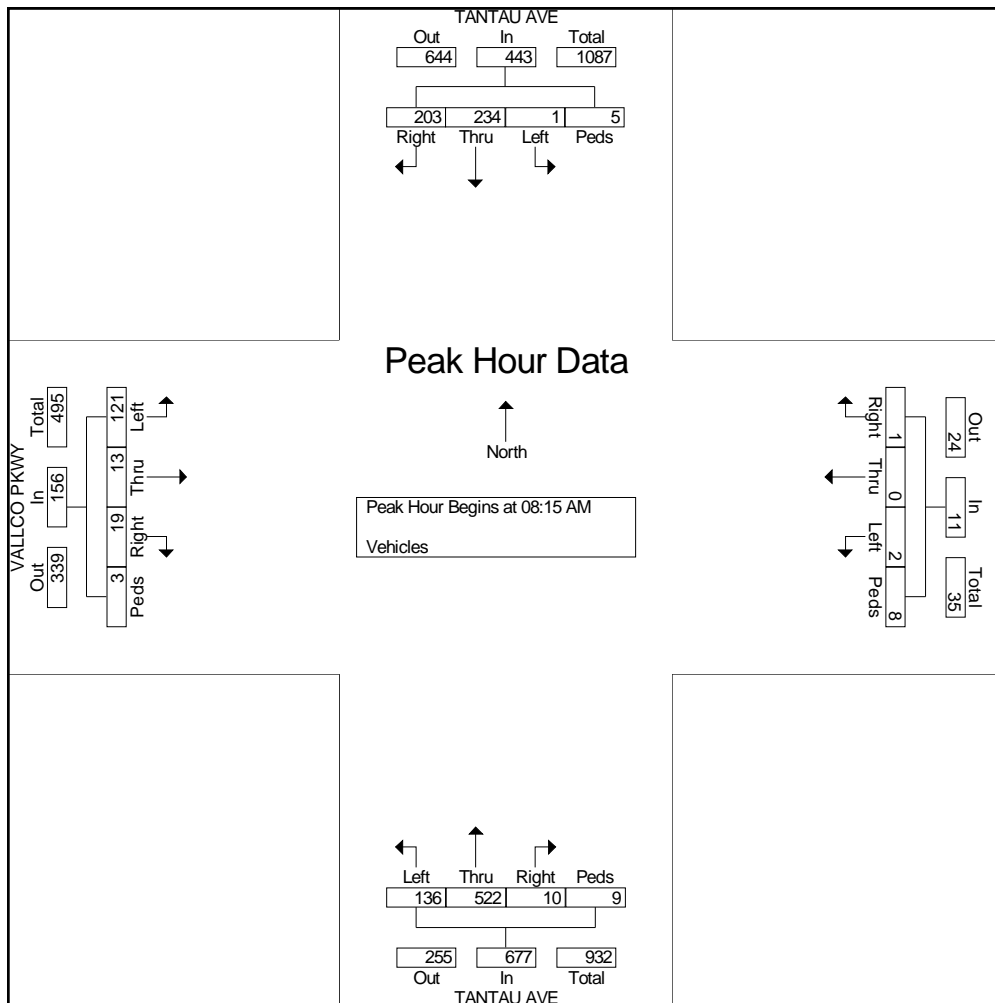

Traffic Data Service

Campbell, CA
(408) 377-2988
tdsbay@cs.com

File Name : 25PM FINAL
Site Code : 00000025
Start Date : 6/2/2011
Page No : 1

Groups Printed- Vehicles

Start Time	TANTAU AVE Southbound					DRIVEWAY Westbound					TANTAU AVE Northbound					VALLCO PKWY Eastbound					Int. Total
	Right	Thru	Left	Peds	App. Total	Right	Thru	Left	Peds	App. Total	Right	Thru	Left	Peds	App. Total	Right	Thru	Left	Peds	App. Total	
04:00 PM	41	58	0	1	100	1	2	1	2	6	0	34	7	0	41	12	0	22	0	34	181
04:15 PM	26	47	0	0	73	0	1	0	0	1	0	43	11	0	54	16	0	16	0	32	160
04:30 PM	37	52	0	0	89	2	4	2	0	8	0	33	11	0	44	13	0	23	0	36	177
04:45 PM	38	77	0	0	115	1	3	0	2	6	0	32	15	3	50	17	1	31	3	52	223
Total	142	234	0	1	377	4	10	3	4	21	0	142	44	3	189	58	1	92	3	154	741
05:00 PM	57	115	0	1	173	0	10	4	2	16	1	44	17	0	62	25	0	30	0	55	306
05:15 PM	56	126	0	3	185	0	2	4	0	6	0	46	13	0	59	38	0	56	2	96	346
05:30 PM	33	119	1	8	161	1	5	3	1	10	0	42	9	1	52	41	0	43	0	84	307
05:45 PM	44	114	0	5	163	1	9	1	0	11	0	44	8	0	52	41	0	49	0	90	316
Total	190	474	1	17	682	2	26	12	3	43	1	176	47	1	225	145	0	178	2	325	1275
06:00 PM	47	110	0	7	164	1	10	3	2	16	1	33	8	1	43	32	0	50	0	82	305
06:15 PM	40	77	0	4	121	0	7	0	2	9	1	49	14	0	64	24	0	27	0	51	245
06:30 PM	35	87	0	4	126	1	1	1	1	4	0	42	11	0	53	31	0	32	2	65	248
06:45 PM	26	66	0	4	96	2	3	0	0	5	0	30	6	0	36	17	1	26	0	44	181
Total	148	340	0	19	507	4	21	4	5	34	2	154	39	1	196	104	1	135	2	242	979
Grand Total	480	1048	1	37	1566	10	57	19	12	98	3	472	130	5	610	307	2	405	7	721	2995
Apprch %	30.7	66.9	0.1	2.4		10.2	58.2	19.4	12.2		0.5	77.4	21.3	0.8		42.6	0.3	56.2	1		
Total %	16	35	0	1.2	52.3	0.3	1.9	0.6	0.4	3.3	0.1	15.8	4.3	0.2	20.4	10.3	0.1	13.5	0.2	24.1	

Start Time	TANTAU AVE Southbound					DRIVEWAY Westbound					TANTAU AVE Northbound					VALLCO PKWY Eastbound					Int. Total
	Right	Thru	Left	Peds	App. Total	Right	Thru	Left	Peds	App. Total	Right	Thru	Left	Peds	App. Total	Right	Thru	Left	Peds	App. Total	
Peak Hour Analysis From 04:00 PM to 06:45 PM - Peak 1 of 1																					
Peak Hour for Entire Intersection Begins at 05:00 PM																					
05:00 PM	57	115	0	1	173	0	10	4	2	16	1	44	17	0	62	25	0	30	0	55	306
05:15 PM	56	126	0	3	185	0	2	4	0	6	0	46	13	0	59	38	0	56	2	96	346
05:30 PM	33	119	1	8	161	1	5	3	1	10	0	42	9	1	52	41	0	43	0	84	307
05:45 PM	44	114	0	5	163	1	9	1	0	11	0	44	8	0	52	41	0	49	0	90	316
Total Volume	190	474	1	17	682	2	26	12	3	43	1	176	47	1	225	145	0	178	2	325	1275
% App. Total	27.9	69.5	0.1	2.5		4.7	60.5	27.9	7		0.4	78.2	20.9	0.4		44.6	0	54.8	0.6		
PHF	.833	.940	.250	.531	.922	.500	.650	.750	.375	.672	.250	.957	.691	.250	.907	.884	.000	.795	.250	.846	.921

Traffic Data Service

Campbell, CA
 (408) 377-2988
 tdsbay@cs.com

File Name : 25PM FINAL
 Site Code : 00000025
 Start Date : 6/2/2011
 Page No : 2

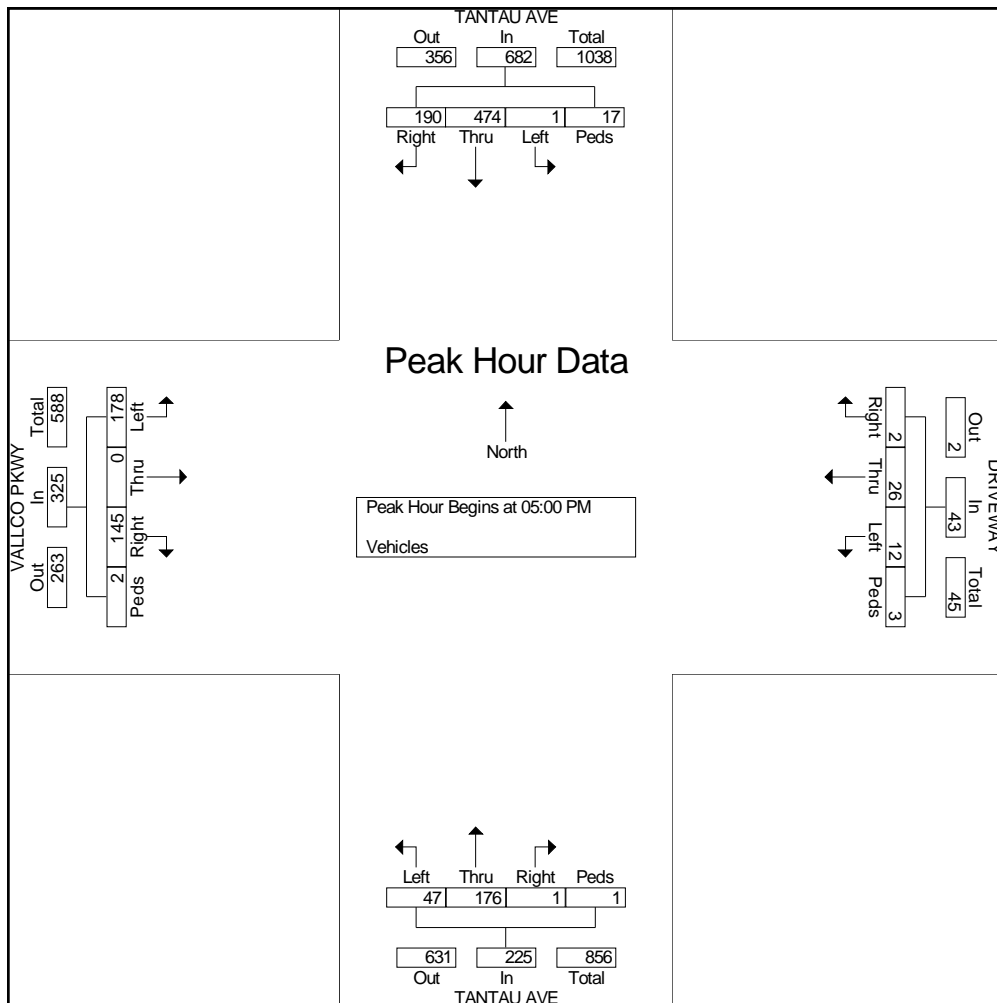

Traffic Data Service

Campbell, CA
(408) 377-2988
tdsbay@cs.com

File Name : 26AM FINAL
Site Code : 00000026
Start Date : 5/12/2011
Page No : 1

Groups Printed- Vehicles

Start Time	N TANTAU AVE Southbound					STEVENS CREEK BLVD Westbound					TANTAU AVE Northbound					STEVENS CREEK BLVD Eastbound					Int. Total
	Right	Thru	Left	Peds	App. Total	Right	Thru	Left	Peds	App. Total	Right	Thru	Left	Peds	App. Total	Right	Thru	Left	Peds	App. Total	
06:30 AM	3	0	2	0	5	13	18	4	0	35	6	7	5	0	18	1	19	8	2	30	88
06:45 AM	5	0	10	0	15	27	52	8	0	87	2	10	5	5	22	3	30	5	1	39	163
Total	8	0	12	0	20	40	70	12	0	122	8	17	10	5	40	4	49	13	3	69	251
07:00 AM	9	0	6	0	15	18	83	5	0	106	6	4	6	0	16	0	38	11	2	51	188
07:15 AM	30	0	9	1	40	26	169	15	0	210	8	8	15	23	54	7	85	13	2	107	411
07:30 AM	24	0	9	0	33	54	164	47	0	265	26	36	11	15	88	11	191	66	1	269	655
07:45 AM	18	0	8	0	26	53	161	31	0	245	21	34	14	1	70	4	167	20	1	192	533
Total	81	0	32	1	114	151	577	98	0	826	61	82	46	39	228	22	481	110	6	619	1787
08:00 AM	26	0	8	0	34	47	202	12	0	261	10	28	19	1	58	4	187	26	0	217	570
08:15 AM	27	0	13	0	40	59	201	33	0	293	16	36	17	5	74	6	123	28	2	159	566
08:30 AM	23	0	14	0	37	64	171	48	0	283	21	30	15	1	67	8	128	45	2	183	570
08:45 AM	35	0	8	1	44	76	186	21	0	283	14	49	18	8	89	10	152	36	2	200	616
Total	111	0	43	1	155	246	760	114	0	1120	61	143	69	15	288	28	590	135	6	759	2322
09:00 AM	28	0	16	0	44	66	182	23	0	271	17	27	25	6	75	7	140	46	3	196	586
09:15 AM	21	0	13	0	34	63	147	14	0	224	7	23	12	6	48	3	115	28	2	148	454
Grand Total	249	0	116	2	367	566	1736	261	0	2563	154	292	162	71	679	64	1375	332	20	1791	5400
Apprch %	67.8	0	31.6	0.5		22.1	67.7	10.2	0		22.7	43	23.9	10.5		3.6	76.8	18.5	1.1		
Total %	4.6	0	2.1	0	6.8	10.5	32.1	4.8	0	47.5	2.9	5.4	3	1.3	12.6	1.2	25.5	6.1	0.4	33.2	

Start Time	N TANTAU AVE Southbound					STEVENS CREEK BLVD Westbound					TANTAU AVE Northbound					STEVENS CREEK BLVD Eastbound					Int. Total
	Right	Thru	Left	Peds	App. Total	Right	Thru	Left	Peds	App. Total	Right	Thru	Left	Peds	App. Total	Right	Thru	Left	Peds	App. Total	
Peak Hour Analysis From 06:30 AM to 09:15 AM - Peak 1 of 1																					
Peak Hour for Entire Intersection Begins at 08:15 AM																					
08:15 AM	27	0	13	0	40	59	201	33	0	293	16	36	17	5	74	6	123	28	2	159	566
08:30 AM	23	0	14	0	37	64	171	48	0	283	21	30	15	1	67	8	128	45	2	183	570
08:45 AM	35	0	8	1	44	76	186	21	0	283	14	49	18	8	89	10	152	36	2	200	616
09:00 AM	28	0	16	0	44	66	182	23	0	271	17	27	25	6	75	7	140	46	3	196	586
Total Volume	113	0	51	1	165	265	740	125	0	1130	68	142	75	20	305	31	543	155	9	738	2338
% App. Total	68.5	0	30.9	0.6		23.5	65.5	11.1	0		22.3	46.6	24.6	6.6		4.2	73.6	21	1.2		
PHF	.807	.000	.797	.250	.938	.872	.920	.651	.000	.964	.810	.724	.750	.625	.857	.775	.893	.842	.750	.923	.949

Traffic Data Service

Campbell, CA
 (408) 377-2988
 tdsbay@cs.com

File Name : 26AM FINAL
 Site Code : 00000026
 Start Date : 5/12/2011
 Page No : 2

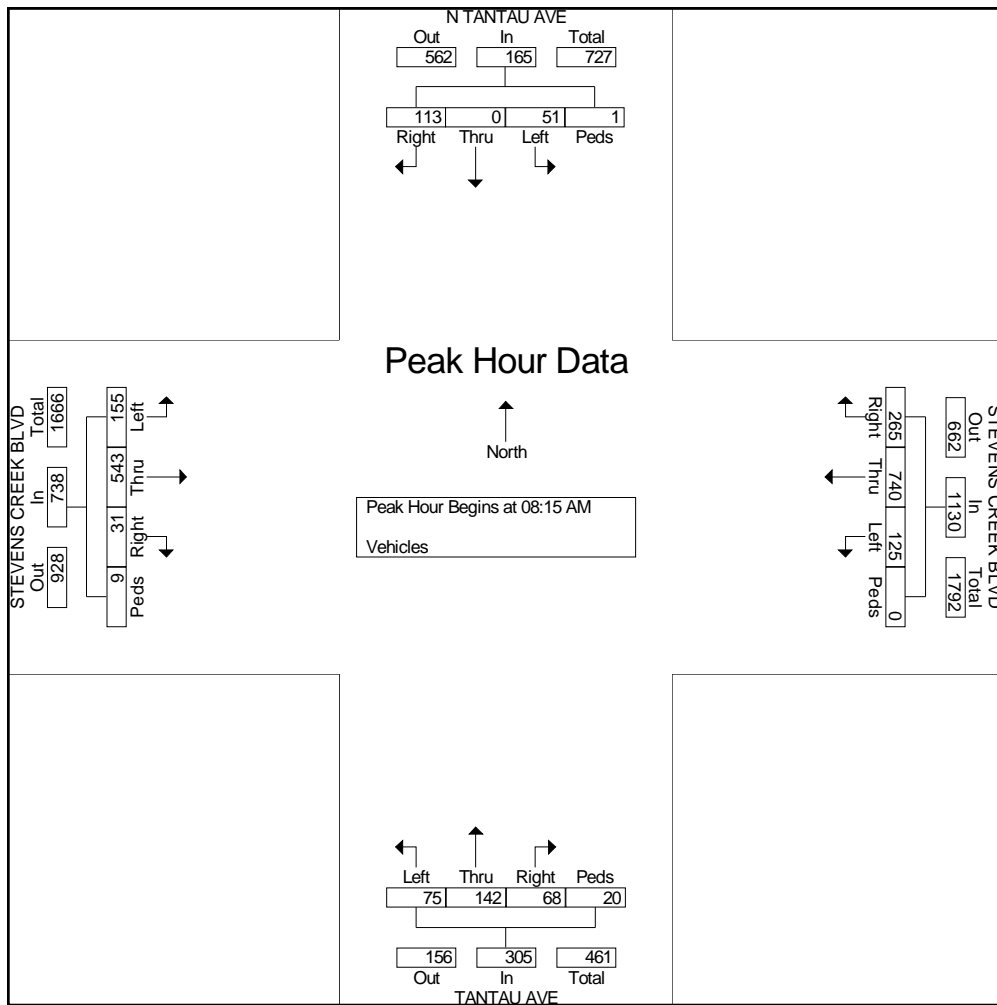

Traffic Data Service

Campbell, CA
(408) 377-2988
tdsbay@cs.com

File Name : 26PM FINAL
Site Code : 00000026
Start Date : 5/12/2011
Page No : 1

Groups Printed- Vehicles

Start Time	N. TANTAU AVE Southbound					STEVENS CREEK BLVD Westbound					TANTAU AVE Northbound					STEVENS CREEK BLVD Eastbound					Int. Total
	Right	Thru	Left	Peds	App. Total	Right	Thru	Left	Peds	App. Total	Right	Thru	Left	Peds	App. Total	Right	Thru	Left	Peds	App. Total	
04:00 PM	26	0	33	1	60	24	128	38	1	191	10	15	10	7	42	8	168	18	2	196	489
04:15 PM	20	0	40	0	60	17	115	10	0	142	4	20	13	8	45	8	204	24	3	239	486
04:30 PM	19	0	60	1	80	13	166	27	0	206	7	8	9	4	28	6	268	24	6	304	618
04:45 PM	31	0	53	0	84	17	128	34	0	179	10	6	8	0	24	17	217	25	3	262	549
Total	96	0	186	2	284	71	537	109	1	718	31	49	40	19	139	39	857	91	14	1001	2142
05:00 PM	34	0	57	0	91	18	142	35	0	195	9	7	11	7	34	10	199	23	8	240	560
05:15 PM	43	0	111	5	159	15	161	34	0	210	14	18	21	5	58	13	301	21	5	340	767
05:30 PM	48	0	69	0	117	18	167	46	0	231	32	13	19	8	72	15	341	24	6	386	806
05:45 PM	54	0	88	2	144	20	191	37	0	248	14	20	16	6	56	15	324	25	3	367	815
Total	179	0	325	7	511	71	661	152	0	884	69	58	67	26	220	53	1165	93	22	1333	2948
06:00 PM	52	0	116	0	168	16	183	41	0	240	6	16	22	7	51	16	325	25	3	369	828
06:15 PM	31	0	97	0	128	11	205	49	0	265	15	9	16	4	44	16	253	20	4	293	730
06:30 PM	39	0	72	2	113	15	179	35	1	230	5	14	13	1	33	17	255	17	0	289	665
06:45 PM	30	0	61	0	91	10	163	42	0	215	11	4	9	3	27	11	153	12	0	176	509
Total	152	0	346	2	500	52	730	167	1	950	37	43	60	15	155	60	986	74	7	1127	2732
Grand Total	427	0	857	11	1295	194	1928	428	2	2552	137	150	167	60	514	152	3008	258	43	3461	7822
Apprch %	33	0	66.2	0.8		7.6	75.5	16.8	0.1		26.7	29.2	32.5	11.7		4.4	86.9	7.5	1.2		
Total %	5.5	0	11	0.1	16.6	2.5	24.6	5.5	0	32.6	1.8	1.9	2.1	0.8	6.6	1.9	38.5	3.3	0.5	44.2	

Start Time	N. TANTAU AVE Southbound					STEVENS CREEK BLVD Westbound					TANTAU AVE Northbound					STEVENS CREEK BLVD Eastbound					Int. Total
	Right	Thru	Left	Peds	App. Total	Right	Thru	Left	Peds	App. Total	Right	Thru	Left	Peds	App. Total	Right	Thru	Left	Peds	App. Total	
Peak Hour Analysis From 04:00 PM to 06:45 PM - Peak 1 of 1																					
Peak Hour for Entire Intersection Begins at 05:15 PM																					
05:15 PM	43	0	111	5	159	15	161	34	0	210	14	18	21	5	58	13	301	21	5	340	767
05:30 PM	48	0	69	0	117	18	167	46	0	231	32	13	19	8	72	15	341	24	6	386	806
05:45 PM	54	0	88	2	144	20	191	37	0	248	14	20	16	6	56	15	324	25	3	367	815
06:00 PM	52	0	116	0	168	16	183	41	0	240	6	16	22	7	51	16	325	25	3	369	828
Total Volume	197	0	384	7	588	69	702	158	0	929	66	67	78	26	237	59	1291	95	17	1462	3216
% App. Total	33.5	0	65.3	1.2		7.4	75.6	17	0		27.8	28.3	32.9	11		4	88.3	6.5	1.2		
PHF	.912	.000	.828	.350	.875	.863	.919	.859	.000	.936	.516	.838	.886	.813	.823	.922	.946	.950	.708	.947	.971

Traffic Data Service

Campbell, CA
 (408) 377-2988
 tdsbay@cs.com

File Name : 26PM FINAL
 Site Code : 00000026
 Start Date : 5/12/2011
 Page No : 2

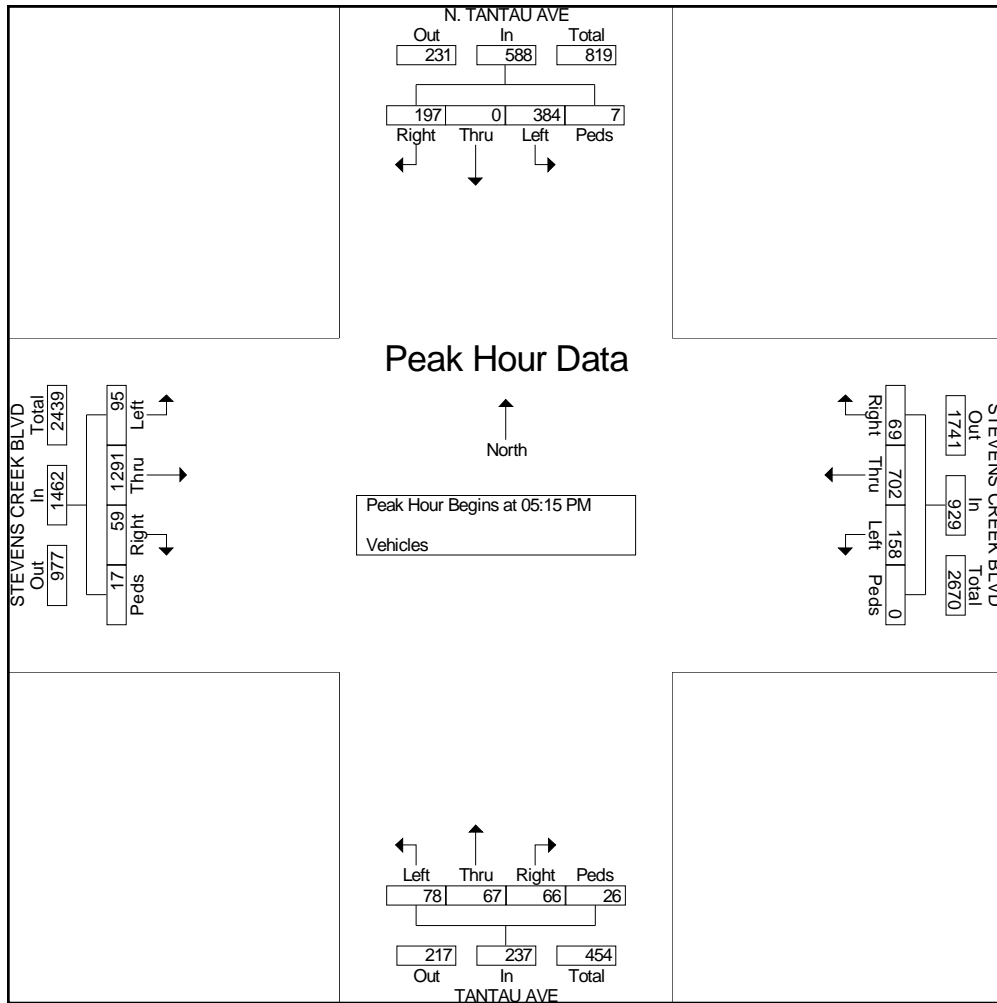

Traffic Data Service

Campbell, CA
 (408) 377-2988
 tdsbay@cs.com

File Name : 29AM FINAL
 Site Code : 00000029
 Start Date : 5/17/2011
 Page No : 1

Groups Printed- Vehicles

Start Time	LAWRENCE EXPY Southbound					HOMESTEAD RD Westbound					LAWRENCE EXPY Northbound					HOMESTEAD RD Eastbound					Int. Total
	Right	Thru	Left	Peds	App. Total	Right	Thru	Left	Peds	App. Total	Right	Thru	Left	Peds	App. Total	Right	Thru	Left	Peds	App. Total	
06:30 AM	16	111	6	1	134	26	44	35	0	105	19	223	8	0	250	4	17	14	0	35	524
06:45 AM	33	166	10	1	210	21	61	54	0	136	26	335	17	1	379	12	15	15	0	42	767
Total	49	277	16	2	344	47	105	89	0	241	45	558	25	1	629	16	32	29	0	77	1291
07:00 AM	21	175	9	0	205	33	63	55	0	151	31	348	8	2	389	13	22	21	1	57	802
07:15 AM	59	273	10	0	342	55	102	85	0	242	31	464	8	0	503	25	38	39	0	102	1189
07:30 AM	72	316	17	1	406	71	90	69	0	230	38	742	32	0	812	17	35	55	4	111	1559
07:45 AM	68	293	22	3	386	83	154	101	0	338	66	897	58	0	1021	30	69	74	2	175	1920
Total	220	1057	58	4	1339	242	409	310	0	961	166	2451	106	2	2725	85	164	189	7	445	5470
08:00 AM	99	318	29	2	448	74	160	96	8	338	60	742	47	0	849	24	74	63	5	166	1801
08:15 AM	108	329	36	4	477	85	129	96	2	312	72	930	37	2	1041	30	65	76	3	174	2004
08:30 AM	75	369	18	1	463	86	163	74	1	324	51	915	58	2	1026	36	96	56	3	191	2004
08:45 AM	107	349	23	0	479	54	131	92	1	278	60	789	116	1	966	39	87	91	0	217	1940
Total	389	1365	106	7	1867	299	583	358	12	1252	243	3376	258	5	3882	129	322	286	11	748	7749
09:00 AM	80	262	20	0	362	52	115	83	8	258	45	757	41	1	844	23	73	88	6	190	1654
09:15 AM	55	148	7	1	211	40	91	51	1	183	41	724	40	0	805	13	30	31	1	75	1274
Grand Total	793	3109	207	14	4123	680	1303	891	21	2895	540	7866	470	9	8885	266	621	623	25	1535	17438
Apprch %	19.2	75.4	5	0.3		23.5	45	30.8	0.7		6.1	88.5	5.3	0.1		17.3	40.5	40.6	1.6		
Total %	4.5	17.8	1.2	0.1	23.6	3.9	7.5	5.1	0.1	16.6	3.1	45.1	2.7	0.1	51	1.5	3.6	3.6	0.1	8.8	

Start Time	LAWRENCE EXPY Southbound					HOMESTEAD RD Westbound					LAWRENCE EXPY Northbound					HOMESTEAD RD Eastbound					Int. Total
	Right	Thru	Left	Peds	App. Total	Right	Thru	Left	Peds	App. Total	Right	Thru	Left	Peds	App. Total	Right	Thru	Left	Peds	App. Total	
Peak Hour Analysis From 06:30 AM to 08:15 AM - Peak 1 of 1																					
Peak Hour for Entire Intersection Begins at 07:30 AM																					
07:30 AM	72	316	17	1	406	71	90	69	0	230	38	742	32	0	812	17	35	55	4	111	1559
07:45 AM	68	293	22	3	386	83	154	101	0	338	66	897	58	0	1021	30	69	74	2	175	1920
08:00 AM	99	318	29	2	448	74	160	96	8	338	60	742	47	0	849	24	74	63	5	166	1801
08:15 AM	108	329	36	4	477	85	129	96	2	312	72	930	37	2	1041	30	65	76	3	174	2004
Total Volume	347	1256	104	10	1717	313	533	362	10	1218	236	3311	174	2	3723	101	243	268	14	626	7284
% App. Total																					
PHF	.803	.954	.722	.625	.900	.921	.833	.896	.313	.901	.819	.890	.750	.250	.894	.842	.821	.882	.700	.894	.909

Traffic Data Service

Campbell, CA
 (408) 377-2988
 tdsbay@cs.com

File Name : 29AM FINAL
 Site Code : 00000029
 Start Date : 5/17/2011
 Page No : 2

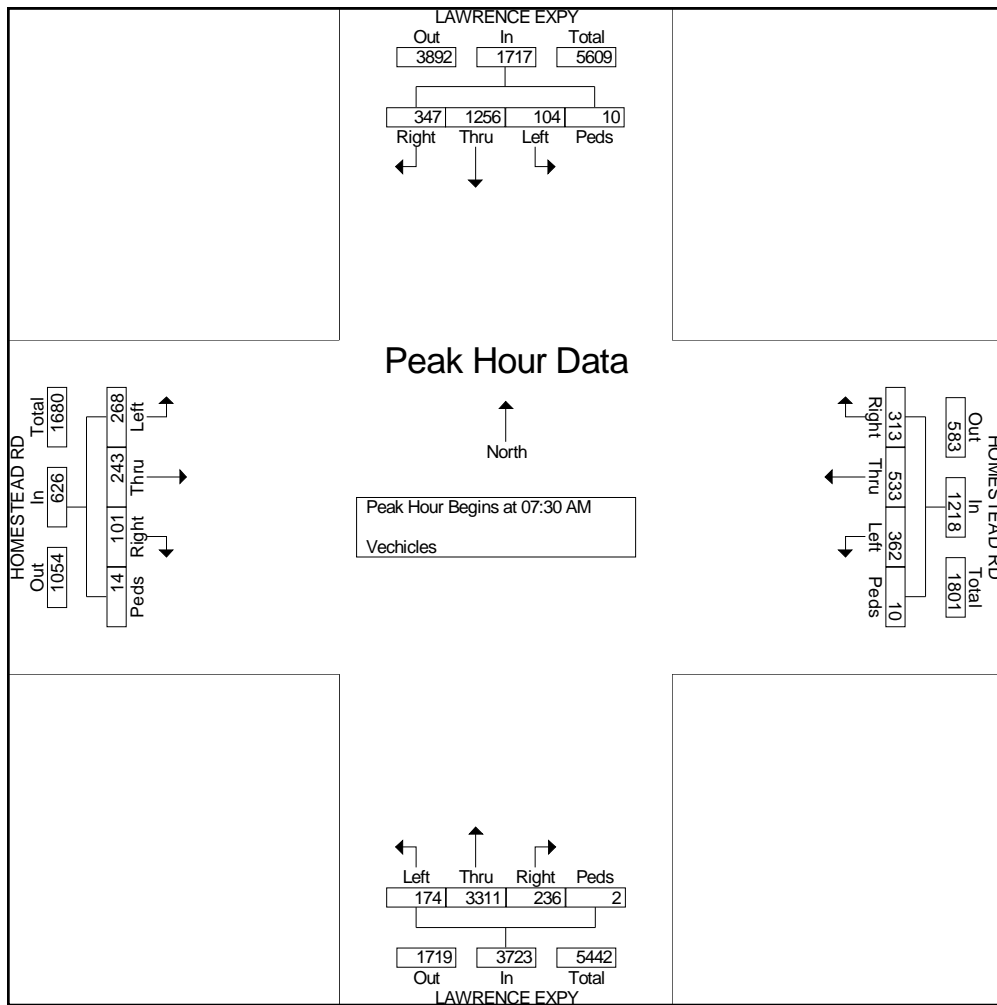

Traffic Data Service

Campbell, CA
(408) 377-2988
tdsbay@cs.com

File Name : 29PM FINAL
Site Code : 00000029
Start Date : 6/2/2011
Page No : 1

Groups Printed- Vehicles

Start Time	LAWRENCE EXPY Southbound					HOMESTEAD RD Westbound					LAWRENCE EXPY Northbound					HOMESTEAD RD Eastbound					Int. Total
	Right	Thru	Left	Peds	App. Total	Right	Thru	Left	Peds	App. Total	Right	Thru	Left	Peds	App. Total	Right	Thru	Left	Peds	App. Total	
04:00 PM	50	412	34	1	497	33	72	59	0	164	52	313	36	1	402	34	98	54	0	186	1249
04:15 PM	68	508	48	0	624	31	80	62	1	174	60	340	40	0	440	39	103	50	0	192	1430
04:30 PM	79	555	52	1	687	43	74	76	0	193	88	404	17	1	510	51	119	85	2	257	1647
04:45 PM	108	597	40	0	745	43	96	56	2	197	107	384	32	0	523	67	118	73	0	258	1723
Total	305	2072	174	2	2553	150	322	253	3	728	307	1441	125	2	1875	191	438	262	2	893	6049
05:00 PM	94	777	53	2	926	33	72	48	0	153	93	379	33	0	505	64	155	87	2	308	1892
05:15 PM	98	753	59	3	913	52	109	78	4	243	81	382	25	0	488	73	137	104	0	314	1958
05:30 PM	106	872	54	1	1033	46	110	80	1	237	98	430	27	1	556	65	147	109	1	322	2148
05:45 PM	108	843	70	0	1021	34	118	80	0	232	133	444	28	0	605	63	149	82	1	295	2153
Total	406	3245	236	6	3893	165	409	286	5	865	405	1635	113	1	2154	265	588	382	4	1239	8151
06:00 PM	103	839	69	1	1012	32	96	87	0	215	93	431	31	1	556	56	156	107	2	321	2104
06:15 PM	89	810	61	1	961	32	125	103	0	260	92	419	29	3	543	42	154	87	0	283	2047
06:30 PM	116	873	57	1	1047	43	109	93	6	251	59	301	30	5	395	46	107	79	1	233	1926
06:45 PM	50	425	38	0	513	37	77	62	0	176	58	311	29	1	399	28	75	36	0	139	1227
Total	358	2947	225	3	3533	144	407	345	6	902	302	1462	119	10	1893	172	492	309	3	976	7304
Grand Total	1069	8264	635	11	9979	459	1138	884	14	2495	1014	4538	357	13	5922	628	1518	953	9	3108	21504
Apprch %	10.7	82.8	6.4	0.1		18.4	45.6	35.4	0.6		17.1	76.6	6	0.2		20.2	48.8	30.7	0.3		
Total %	5	38.4	3	0.1	46.4	2.1	5.3	4.1	0.1	11.6	4.7	21.1	1.7	0.1	27.5	2.9	7.1	4.4	0	14.5	

Start Time	LAWRENCE EXPY Southbound					HOMESTEAD RD Westbound					LAWRENCE EXPY Northbound					HOMESTEAD RD Eastbound					Int. Total
	Right	Thru	Left	Peds	App. Total	Right	Thru	Left	Peds	App. Total	Right	Thru	Left	Peds	App. Total	Right	Thru	Left	Peds	App. Total	
Peak Hour Analysis From 04:00 PM to 06:45 PM - Peak 1 of 1																					
Peak Hour for Entire Intersection Begins at 05:30 PM																					
05:30 PM	106	872	54	1	1033	46	110	80	1	237	98	430	27	1	556	65	147	109	1	322	2148
05:45 PM	108	843	70	0	1021	34	118	80	0	232	133	444	28	0	605	63	149	82	1	295	2153
06:00 PM	103	839	69	1	1012	32	96	87	0	215	93	431	31	1	556	56	156	107	2	321	2104
06:15 PM	89	810	61	1	961	32	125	103	0	260	92	419	29	3	543	42	154	87	0	283	2047
Total Volume	406	3364	254	3	4027	144	449	350	1	944	416	1724	115	5	2260	226	606	385	4	1221	8452
% App. Total																					
PHF	.940	.964	.907	.750	.975	.783	.898	.850	.250	.908	.782	.971	.927	.417	.934	.869	.971	.883	.500	.948	.981

Traffic Data Service

Campbell, CA
 (408) 377-2988
 tdsbay@cs.com

File Name : 29PM FINAL
 Site Code : 00000029
 Start Date : 6/2/2011
 Page No : 2

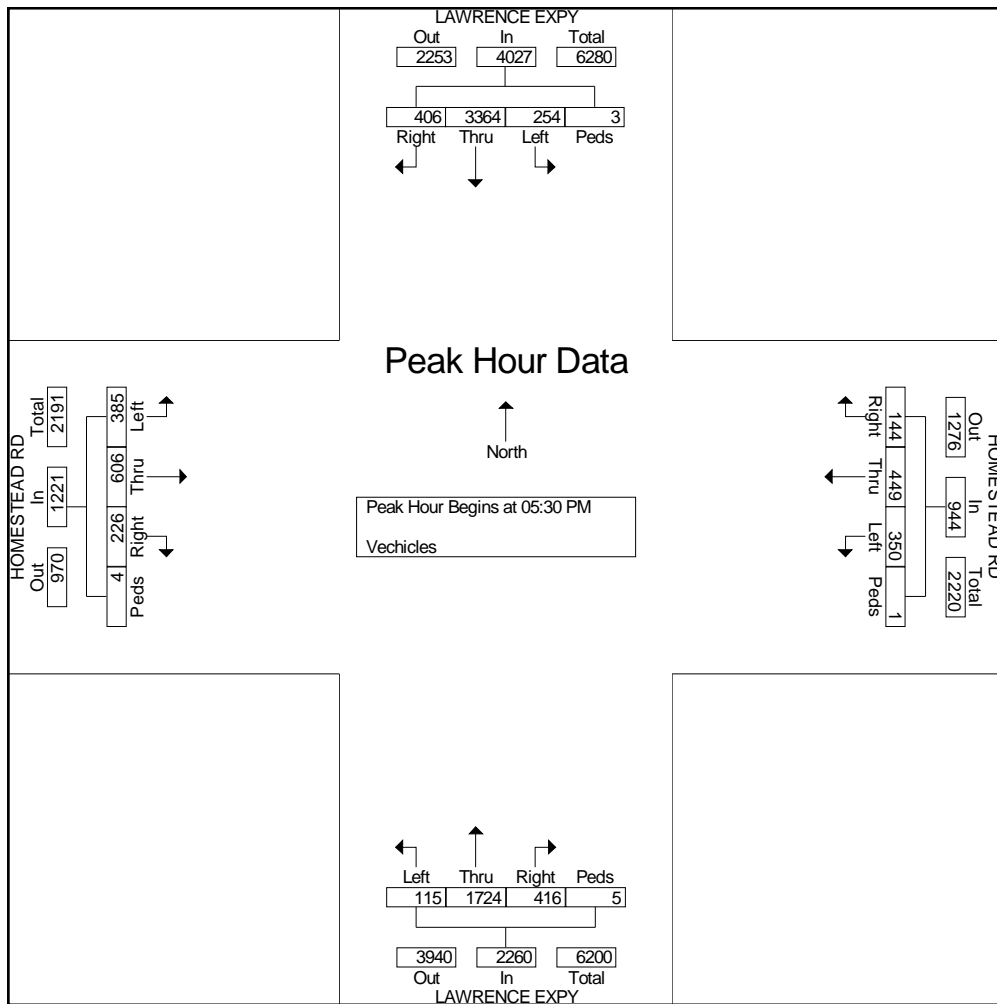

Traffic Data Service

Campbell, CA
(408) 377-2988
tdsbay@cs.com

File Name : 12PM FINAL
Site Code : 00000012
Start Date : 3/31/2015
Page No : 1

Groups Printed- Vehicles

Start Time	S WOLFE RD Southbound					E EL CAMINO REAL Westbound					S WOLFE RD Northbound					E EL CAMINO REAL Eastbound					Int. Total
	Right	Thru	Left	Peds	App. Total	Right	Thru	Left	Peds	App. Total	Right	Thru	Left	Peds	App. Total	Right	Thru	Left	Peds	App. Total	
04:00 PM	12	131	39	2	184	29	153	69	5	256	25	98	53	3	179	85	241	12	1	339	958
04:15 PM	24	151	32	0	207	18	152	76	8	254	28	89	60	3	180	110	277	15	1	403	1044
04:30 PM	22	169	40	2	233	30	163	73	1	267	31	90	60	4	185	110	257	23	0	390	1075
04:45 PM	24	203	46	0	273	32	143	85	6	266	30	88	53	6	177	91	292	26	0	409	1125
Total	82	654	157	4	897	109	611	303	20	1043	114	365	226	16	721	396	1067	76	2	1541	4202
05:00 PM	19	270	52	2	343	33	172	95	8	308	23	102	53	0	178	87	272	19	0	378	1207
05:15 PM	27	299	65	4	395	32	160	87	1	280	37	152	95	3	287	103	310	24	0	437	1399
05:30 PM	24	268	44	8	344	39	257	81	2	379	48	141	67	0	256	107	322	26	0	455	1434
05:45 PM	22	298	70	6	396	28	270	102	9	409	49	130	72	0	251	107	316	15	0	438	1494
Total	92	1135	231	20	1478	132	859	365	20	1376	157	525	287	3	972	404	1220	84	0	1708	5534
06:00 PM	29	300	71	0	400	25	147	76	3	251	36	122	73	2	233	96	291	13	0	400	1284
06:15 PM	31	287	57	5	380	41	118	103	2	264	35	153	86	9	283	106	332	20	0	458	1385
06:30 PM	23	238	67	1	329	36	178	99	1	314	27	93	58	0	178	110	292	25	0	427	1248
06:45 PM	28	185	49	4	266	28	163	82	6	279	50	141	62	1	254	98	300	23	0	421	1220
Total	111	1010	244	10	1375	130	606	360	12	1108	148	509	279	12	948	410	1215	81	0	1706	5137
Grand Total	285	2799	632	34	3750	371	2076	1028	52	3527	419	1399	792	31	2641	1210	3502	241	2	4955	14873
Apprch %	7.6	74.6	16.9	0.9		10.5	58.9	29.1	1.5		15.9	53	30	1.2		24.4	70.7	4.9	0		
Total %	1.9	18.8	4.2	0.2	25.2	2.5	14	6.9	0.3	23.7	2.8	9.4	5.3	0.2	17.8	8.1	23.5	1.6	0	33.3	

Start Time	S WOLFE RD Southbound				E EL CAMINO REAL Westbound				S WOLFE RD Northbound				E EL CAMINO REAL Eastbound				Int. Total
	Right	Thru	Left	App. Total	Right	Thru	Left	App. Total	Right	Thru	Left	App. Total	Right	Thru	Left	App. Total	
Peak Hour Analysis From 04:00 PM to 06:45 PM - Peak 1 of 1																	
Peak Hour for Entire Intersection Begins at 05:15 PM																	
05:15 PM	27	299	65	391	32	160	87	279	37	152	95	284	103	310	24	437	1391
05:30 PM	24	268	44	336	39	257	81	377	48	141	67	256	107	322	26	455	1424
05:45 PM	22	298	70	390	28	270	102	400	49	130	72	251	107	316	15	438	1479
06:00 PM	29	300	71	400	25	147	76	248	36	122	73	231	96	291	13	400	1279
Total Volume	102	1165	250	1517	124	834	346	1304	170	545	307	1022	413	1239	78	1730	5573
% App. Total	6.7	76.8	16.5		9.5	64	26.5		16.6	53.3	30		23.9	71.6	4.5		
PHF	.879	.971	.880	.948	.795	.772	.848	.815	.867	.896	.808	.900	.965	.962	.750	.951	.942

Traffic Data Service

Campbell, CA
 (408) 377-2988
idsbay@cs.com

File Name : 12PM FINAL
 Site Code : 00000012
 Start Date : 3/31/2015
 Page No : 2

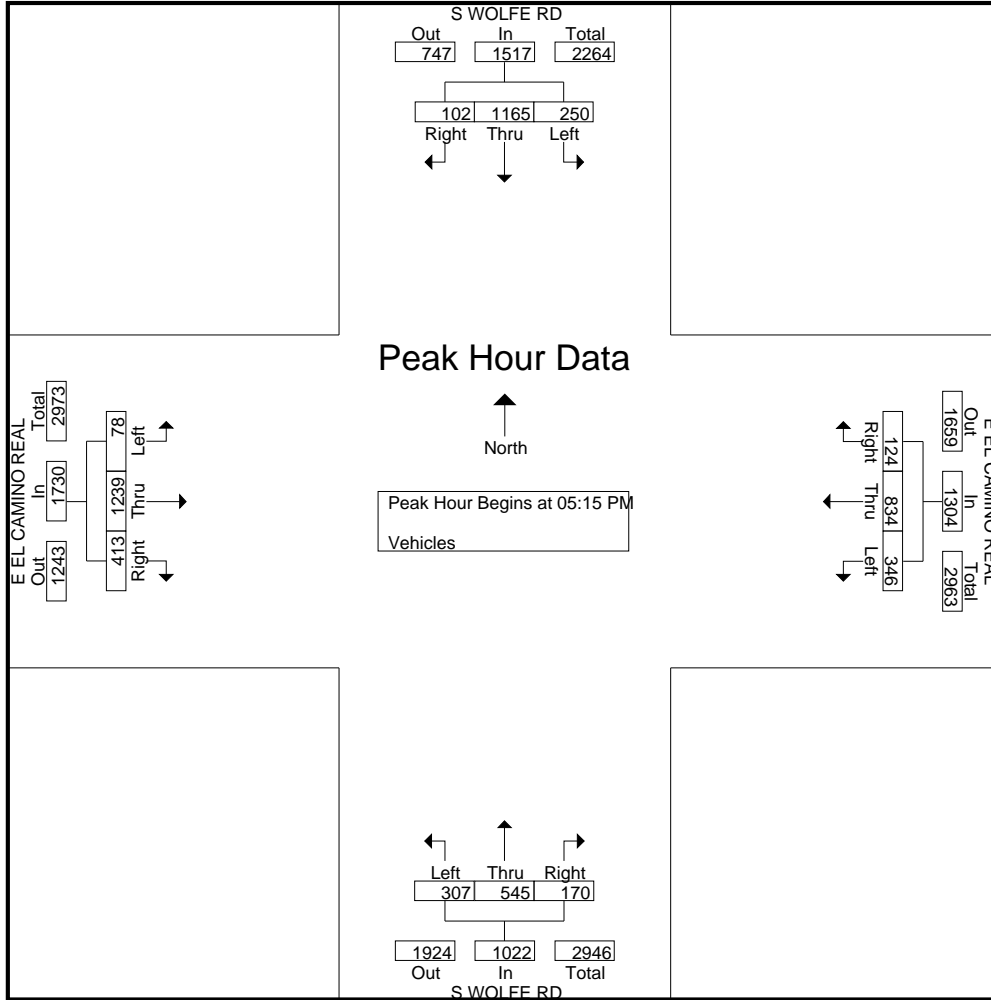

Traffic Data Service

Campbell, CA
 (408) 377-2988
 tdsbay@cs.com

File Name : 13AM FINAL
 Site Code : 00000013
 Start Date : 3/31/2015
 Page No : 1

Groups Printed- Vehicles

Start Time	S WOLFE RD Southbound					E FREMONT AVE Westbound					S WOLFE RD Northbound					E FREMONT AVE Eastbound					Int. Total
	Right	Thru	Left	Peds	App. Total	Right	Thru	Left	Peds	App. Total	Right	Thru	Left	Peds	App. Total	Right	Thru	Left	Peds	App. Total	
07:00 AM	70	80	4	3	157	4	2	2	2	10	9	70	18	4	101	15	25	25	2	67	335
07:15 AM	72	101	2	2	177	5	4	1	2	12	4	119	31	1	155	21	31	54	2	108	452
07:30 AM	78	107	16	1	202	14	3	1	5	23	6	152	32	2	192	33	49	70	2	154	571
07:45 AM	126	132	22	2	282	13	11	1	0	25	11	205	49	0	265	34	46	66	1	147	719
Total	346	420	44	8	818	36	20	5	9	70	30	546	130	7	713	103	151	215	7	476	2077
08:00 AM	113	133	3	3	252	10	10	2	1	23	8	262	39	3	312	29	50	90	6	175	762
08:15 AM	118	137	2	2	259	17	5	0	0	22	6	250	50	0	306	49	75	97	2	223	810
08:30 AM	85	157	8	3	253	24	11	1	0	36	6	282	36	1	325	56	53	110	1	220	834
08:45 AM	107	121	0	4	232	18	10	3	0	31	11	320	47	1	379	21	59	107	6	193	835
Total	423	548	13	12	996	69	36	6	1	112	31	1114	172	5	1322	155	237	404	15	811	3241
09:00 AM	113	124	3	1	241	21	12	0	3	36	8	299	31	3	341	27	43	94	5	169	787
09:15 AM	120	145	7	0	272	20	12	0	3	35	6	305	30	2	343	42	49	77	1	169	819
09:30 AM	90	147	5	0	242	10	4	3	2	19	17	237	28	3	285	35	60	98	1	194	740
09:45 AM	87	152	4	1	244	9	6	0	11	26	11	206	21	2	240	22	45	97	1	165	675
Total	410	568	19	2	999	60	34	3	19	116	42	1047	110	10	1209	126	197	366	8	697	3021
Grand Total	1179	1536	76	22	2813	165	90	14	29	298	103	2707	412	22	3244	384	585	985	30	1984	8339
Apprch %	41.9	54.6	2.7	0.8		55.4	30.2	4.7	9.7		3.2	83.4	12.7	0.7		19.4	29.5	49.6	1.5		
Total %	14.1	18.4	0.9	0.3	33.7	2	1.1	0.2	0.3	3.6	1.2	32.5	4.9	0.3	38.9	4.6	7	11.8	0.4	23.8	

Start Time	S WOLFE RD Southbound				E FREMONT AVE Westbound				S WOLFE RD Northbound				E FREMONT AVE Eastbound				Int. Total
	Right	Thru	Left	App. Total	Right	Thru	Left	App. Total	Right	Thru	Left	App. Total	Right	Thru	Left	App. Total	
Peak Hour Analysis From 07:00 AM to 09:45 AM - Peak 1 of 1																	
Peak Hour for Entire Intersection Begins at 08:30 AM																	
08:30 AM	85	157	8	250	24	11	1	36	6	282	36	324	56	53	110	219	829
08:45 AM	107	121	0	228	18	10	3	31	11	320	47	378	21	59	107	187	824
09:00 AM	113	124	3	240	21	12	0	33	8	299	31	338	27	43	94	164	775
09:15 AM	120	145	7	272	20	12	0	32	6	305	30	341	42	49	77	168	813
Total Volume	425	547	18	990	83	45	4	132	31	1206	144	1381	146	204	388	738	3241
% App. Total	42.9	55.3	1.8		62.9	34.1	3		2.2	87.3	10.4		19.8	27.6	52.6		
PHF	.885	.871	.563	.910	.865	.938	.333	.917	.705	.942	.766	.913	.652	.864	.882	.842	.977

Traffic Data Service

Campbell, CA
 (408) 377-2988
 tdsbay@cs.com

File Name : 13AM FINAL
 Site Code : 00000013
 Start Date : 3/31/2015
 Page No : 2

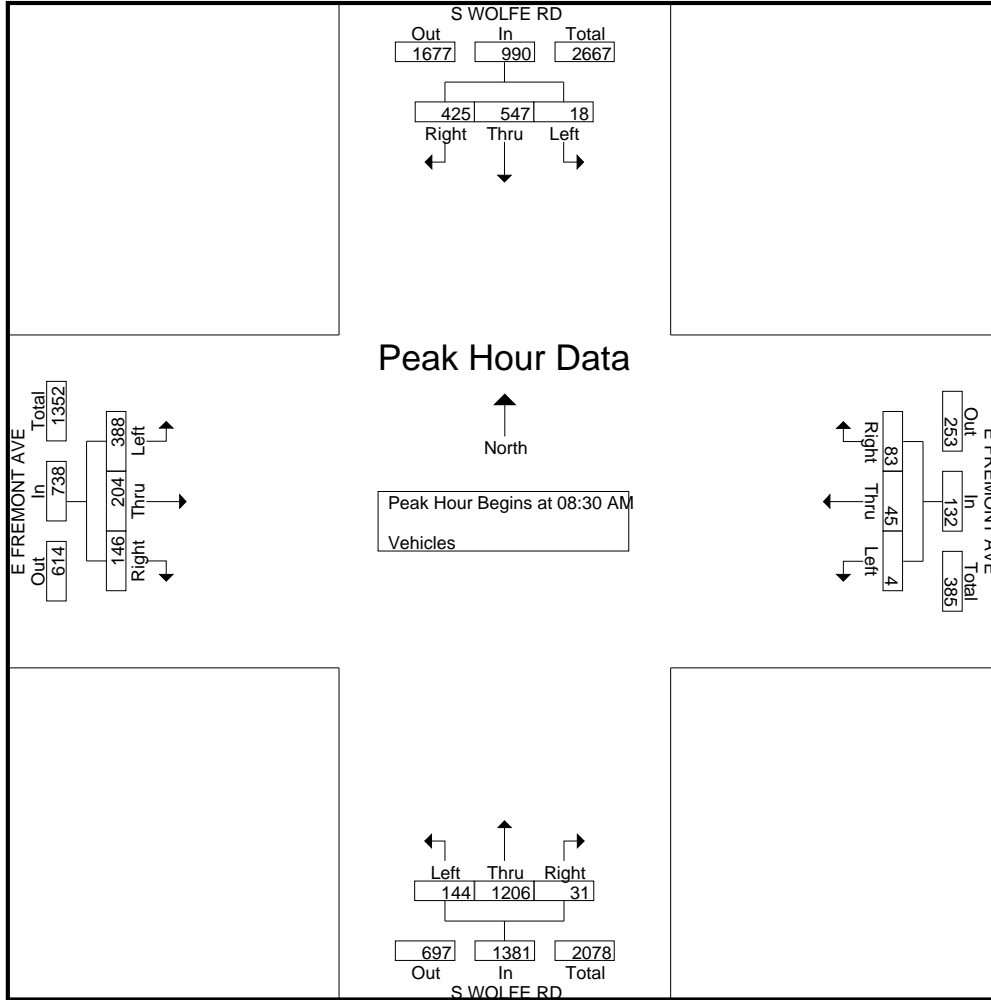

Traffic Data Service

Campbell, CA
(408) 377-2988
tdsbay@cs.com

File Name : 13PM FINAL
Site Code : 00000013
Start Date : 3/31/2015
Page No : 1

Groups Printed- Vehicles

Start Time	S WOLFE RD Southbound					E FREMONT AVE Westbound					S WOLFE RD Northbound					E FREMONT AVE Eastbound					Int. Total
	Right	Thru	Left	Peds	App. Total	Right	Thru	Left	Peds	App. Total	Right	Thru	Left	Peds	App. Total	Right	Thru	Left	Peds	App. Total	
04:00 PM	77	214	5	0	296	7	6	1	3	17	14	121	33	0	168	44	58	48	1	151	632
04:15 PM	95	277	9	1	382	2	5	3	2	12	8	125	42	2	177	61	92	49	0	202	773
04:30 PM	108	265	14	0	387	3	11	0	1	15	17	116	36	6	175	52	65	66	3	186	763
04:45 PM	121	302	6	4	433	8	1	0	2	11	24	115	34	2	175	60	81	59	1	201	820
Total	401	1058	34	5	1498	20	23	4	8	55	63	477	145	10	695	217	296	222	5	740	2988
05:00 PM	135	328	7	1	471	8	5	4	4	21	12	110	30	4	156	80	77	59	2	218	866
05:15 PM	143	347	11	1	502	7	6	0	3	16	12	152	35	0	199	67	96	79	4	246	963
05:30 PM	125	324	12	3	464	9	8	3	2	22	17	162	45	8	232	69	96	86	3	254	972
05:45 PM	145	347	10	0	502	4	10	4	1	19	11	162	42	5	220	93	120	88	2	303	1044
Total	548	1346	40	5	1939	28	29	11	10	78	52	586	152	17	807	309	389	312	11	1021	3845
06:00 PM	104	351	13	0	468	8	14	2	3	27	15	153	48	1	217	98	77	84	0	259	971
06:15 PM	138	340	13	1	492	8	9	2	6	25	10	155	48	6	219	62	109	82	0	253	989
06:30 PM	139	305	9	1	454	8	6	0	5	19	15	123	26	3	167	42	57	53	2	154	794
06:45 PM	101	242	11	0	354	6	9	2	2	19	12	157	31	0	200	47	80	92	0	219	792
Total	482	1238	46	2	1768	30	38	6	16	90	52	588	153	10	803	249	323	311	2	885	3546
Grand Total	1431	3642	120	12	5205	78	90	21	34	223	167	1651	450	37	2305	775	1008	845	18	2646	10379
Apprch %	27.5	70	2.3	0.2		35	40.4	9.4	15.2		7.2	71.6	19.5	1.6		29.3	38.1	31.9	0.7		
Total %	13.8	35.1	1.2	0.1	50.1	0.8	0.9	0.2	0.3	2.1	1.6	15.9	4.3	0.4	22.2	7.5	9.7	8.1	0.2	25.5	

Start Time	S WOLFE RD Southbound				E FREMONT AVE Westbound				S WOLFE RD Northbound				E FREMONT AVE Eastbound				Int. Total
	Right	Thru	Left	App. Total	Right	Thru	Left	App. Total	Right	Thru	Left	App. Total	Right	Thru	Left	App. Total	
Peak Hour Analysis From 04:00 PM to 06:45 PM - Peak 1 of 1																	
Peak Hour for Entire Intersection Begins at 05:30 PM																	
05:30 PM	125	324	12	461	9	8	3	20	17	162	45	224	69	96	86	251	956
05:45 PM	145	347	10	502	4	10	4	18	11	162	42	215	93	120	88	301	1036
06:00 PM	104	351	13	468	8	14	2	24	15	153	48	216	98	77	84	259	967
06:15 PM	138	340	13	491	8	9	2	19	10	155	48	213	62	109	82	253	976
Total Volume	512	1362	48	1922	29	41	11	81	53	632	183	868	322	402	340	1064	3935
% App. Total	26.6	70.9	2.5		35.8	50.6	13.6		6.1	72.8	21.1		30.3	37.8	32		
PHF	.883	.970	.923	.957	.806	.732	.688	.844	.779	.975	.953	.969	.821	.838	.966	.884	.950

Traffic Data Service

Campbell, CA
 (408) 377-2988
tdsbay@cs.com

File Name : 13PM FINAL
 Site Code : 00000013
 Start Date : 3/31/2015
 Page No : 2

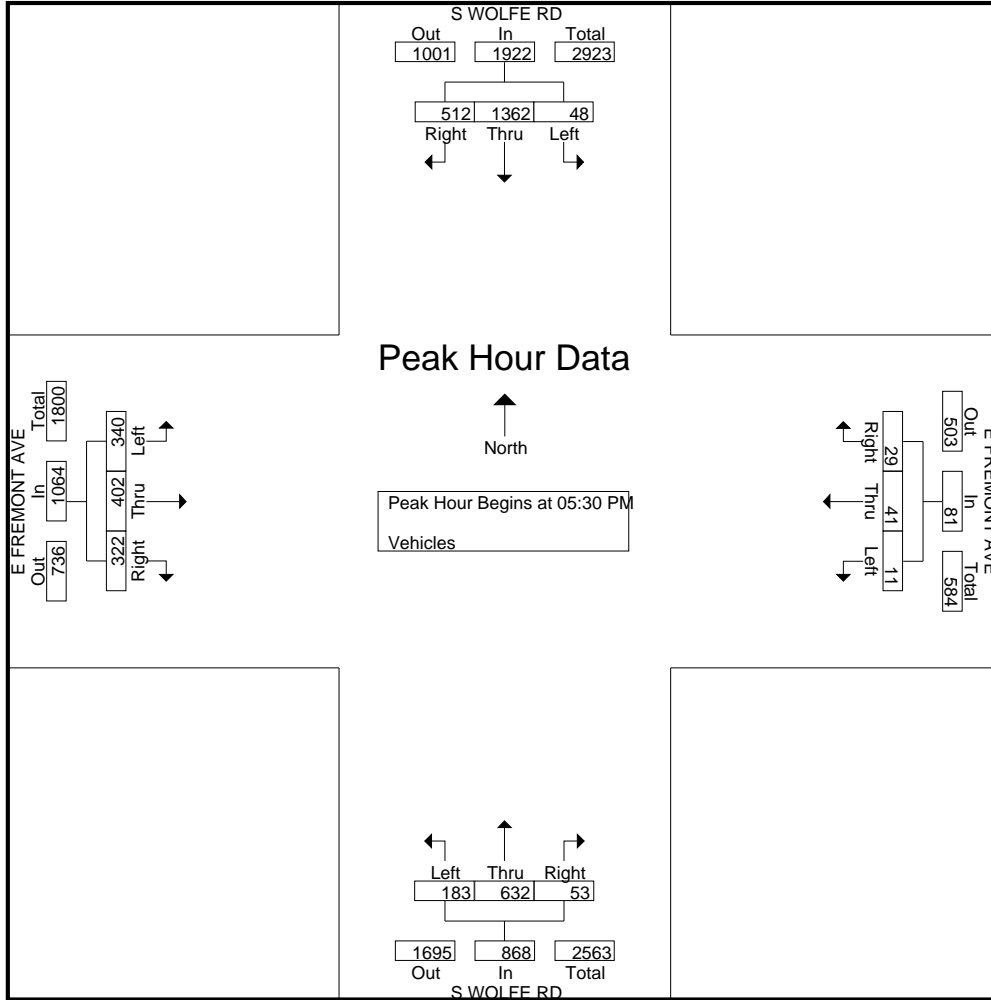

Traffic Data Service

Campbell, CA
 (408) 377-2988
 tdsbay@cs.com

File Name : 3AM FINAL
 Site Code : 00000003
 Start Date : 1/26/2012
 Page No : 2

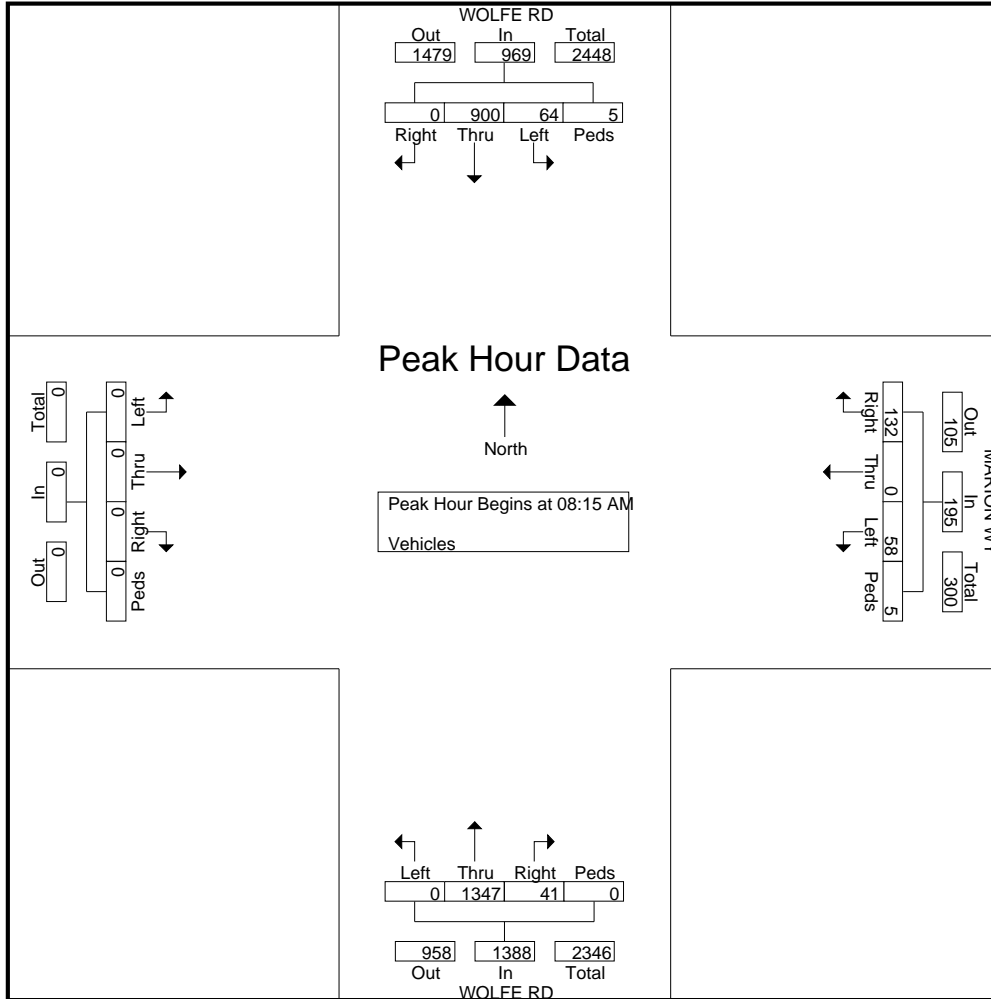

Traffic Data Service

Campbell, CA
 (408) 377-2988
 tdsbay@cs.com

File Name : 3PM FINAL
 Site Code : 00000003
 Start Date : 1/26/2012
 Page No : 2

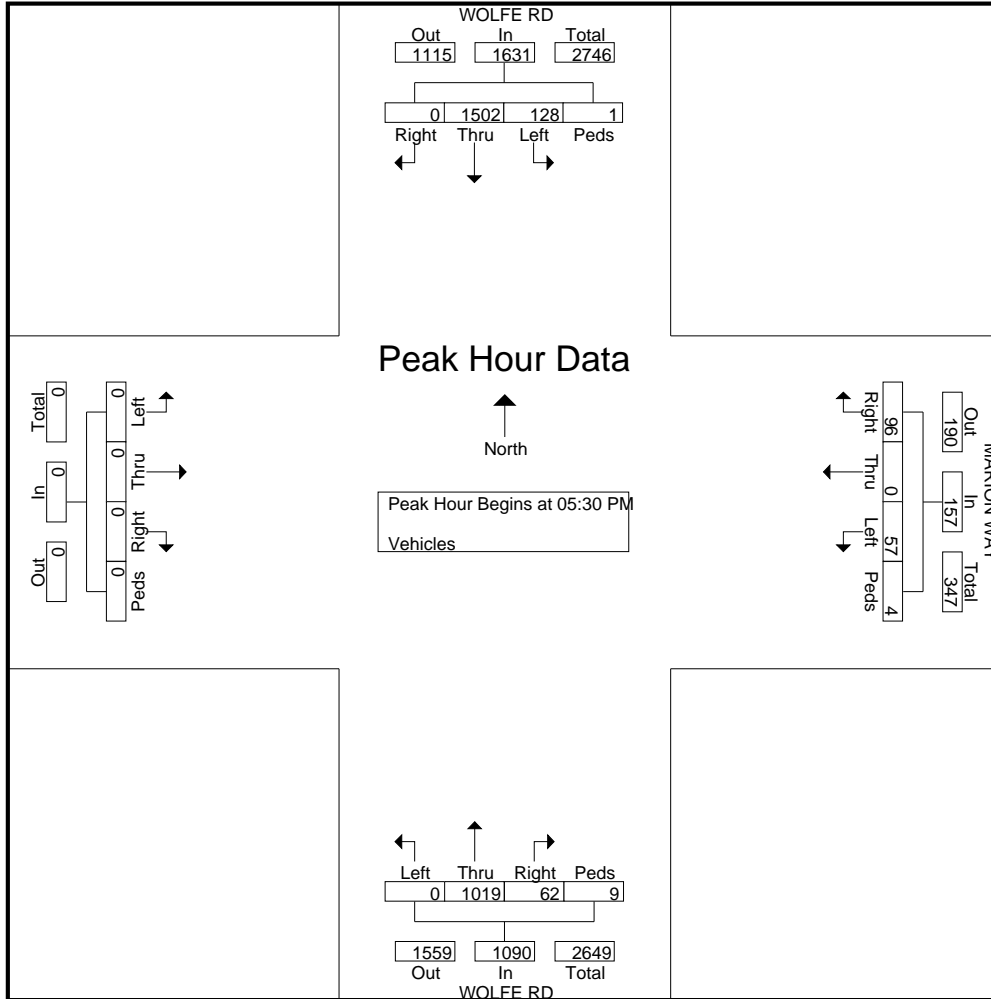

Traffic Data Service

Campbell, CA
 (408) 377-2988
 tdsbay@cs.com

File Name : 4AM FINAL
 Site Code : 00000004
 Start Date : 1/26/2012
 Page No : 1

Groups Printed- Vehicles

Start Time	WOLFE RD Southbound					INVERNESS WAY Westbound					WOLFE RD Northbound					INVERNESS WAY Eastbound					Int. Total
	Right	Thru	Left	Peds	App. Total	Right	Thru	Left	Peds	App. Total	Right	Thru	Left	Peds	App. Total	Right	Thru	Left	Peds	App. Total	
06:30 AM	1	71	0	0	72	2	2	3	0	7	1	64	1	0	66	2	0	5	3	10	155
06:45 AM	1	99	0	1	101	5	0	5	0	10	0	101	1	0	102	10	0	4	2	16	229
Total	2	170	0	1	173	7	2	8	0	17	1	165	2	0	168	12	0	9	5	26	384
07:00 AM	6	120	3	1	130	7	0	10	0	17	1	96	3	0	100	5	0	3	0	8	255
07:15 AM	5	147	2	1	155	11	3	12	0	26	5	94	0	0	99	11	0	3	0	14	294
07:30 AM	5	205	2	2	214	12	3	10	0	25	1	198	2	0	201	18	4	9	3	34	474
07:45 AM	6	186	5	0	197	19	5	6	3	33	11	208	5	0	224	10	9	16	0	35	489
Total	22	658	12	4	696	49	11	38	3	101	18	596	10	0	624	44	13	31	3	91	1512
08:00 AM	7	211	5	0	223	19	8	9	0	36	7	225	7	2	241	12	7	14	0	33	533
08:15 AM	7	269	4	0	280	17	8	8	0	33	7	276	5	0	288	13	10	19	0	42	643
08:30 AM	4	222	4	0	230	18	4	9	0	31	7	295	3	0	305	14	4	16	0	34	600
08:45 AM	13	235	6	0	254	17	5	6	0	28	10	326	2	2	340	19	3	15	2	39	661
Total	31	937	19	0	987	71	25	32	0	128	31	1122	17	4	1174	58	24	64	2	148	2437
09:00 AM	9	214	5	1	229	18	7	6	0	31	6	321	4	2	333	13	2	21	0	36	629
09:15 AM	6	225	8	0	239	12	8	14	1	35	9	220	6	0	235	14	6	20	0	40	549
Grand Total	70	2204	44	6	2324	157	53	98	4	312	65	2424	39	6	2534	141	45	145	10	341	5511
Apprch %	3	94.8	1.9	0.3		50.3	17	31.4	1.3		2.6	95.7	1.5	0.2		41.3	13.2	42.5	2.9		
Total %	1.3	40	0.8	0.1	42.2	2.8	1	1.8	0.1	5.7	1.2	44	0.7	0.1	46	2.6	0.8	2.6	0.2	6.2	

Start Time	WOLFE RD Southbound					INVERNESS WAY Westbound					WOLFE RD Northbound					INVERNESS WAY Eastbound					Int. Total
	Right	Thru	Left	Peds	App. Total	Right	Thru	Left	Peds	App. Total	Right	Thru	Left	Peds	App. Total	Right	Thru	Left	Peds	App. Total	
Peak Hour Analysis From 06:30 AM to 09:15 AM - Peak 1 of 1																					
Peak Hour for Entire Intersection Begins at 08:15 AM																					
08:15 AM	7	269	4	0	280	17	8	8	0	33	7	276	5	0	288	13	10	19	0	42	643
08:30 AM	4	222	4	0	230	18	4	9	0	31	7	295	3	0	305	14	4	16	0	34	600
08:45 AM	13	235	6	0	254	17	5	6	0	28	10	326	2	2	340	19	3	15	2	39	661
09:00 AM	9	214	5	1	229	18	7	6	0	31	6	321	4	2	333	13	2	21	0	36	629
Total Volume	33	940	19	1	993	70	24	29	0	123	30	1218	14	4	1266	59	19	71	2	151	2533
% App. Total	3.3	94.7	1.9	0.1		56.9	19.5	23.6	0		2.4	96.2	1.1	0.3		39.1	12.6	47	1.3		
PHF	.635	.874	.792	.250	.887	.972	.750	.806	.000	.932	.750	.934	.700	.500	.931	.776	.475	.845	.250	.899	.958

Traffic Data Service

Campbell, CA

(408) 377-2988

tdsbay@cs.com

File Name : 4AM FINAL

Site Code : 00000004

Start Date : 1/26/2012

Page No : 2

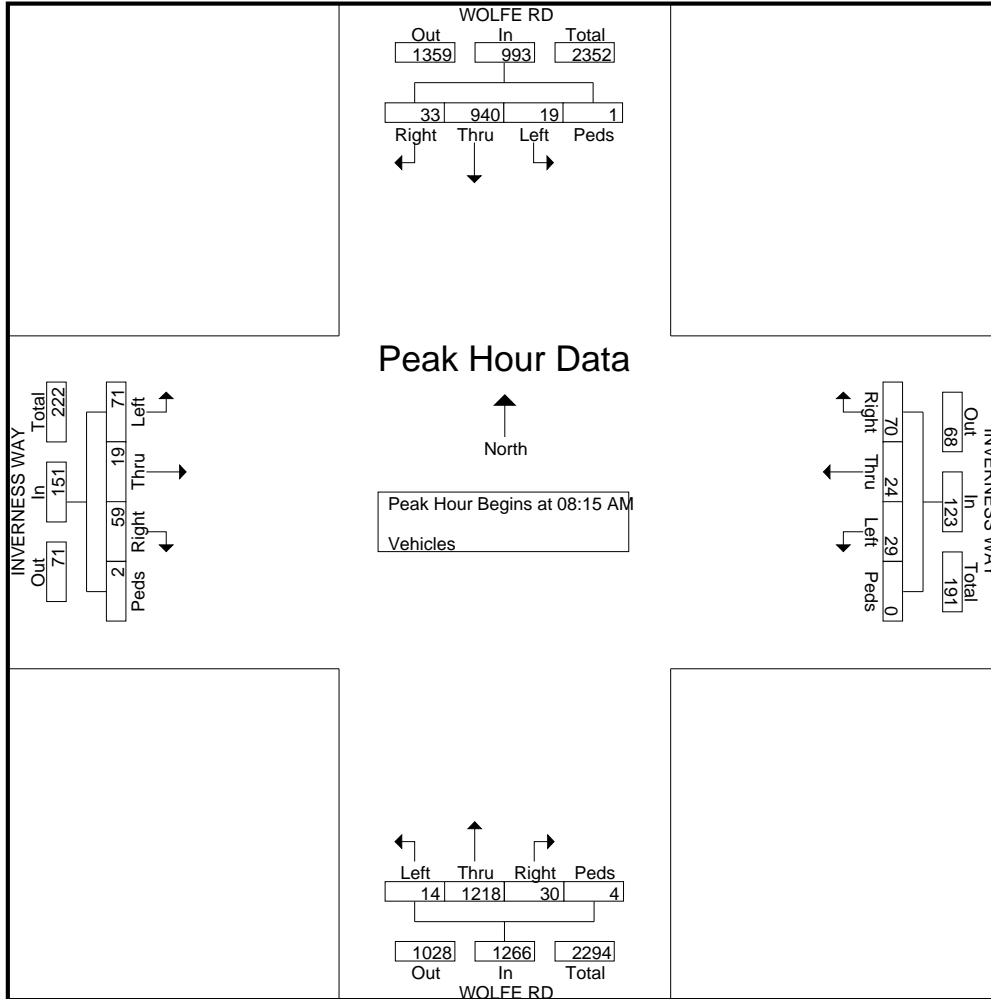

Traffic Data Service

Campbell, CA
(408) 377-2988
tdsbay@cs.com

File Name : 12AM FINAL
Site Code : 00000012
Start Date : 3/31/2015
Page No : 1

Groups Printed- Vehicles

Start Time	S WOLFE RD Southbound					E EL CAMINO REAL Westbound					S WOLFE RD Northbound					E EL CAMINO REAL Eastbound					Int. Total
	Right	Thru	Left	Peds	App. Total	Right	Thru	Left	Peds	App. Total	Right	Thru	Left	Peds	App. Total	Right	Thru	Left	Peds	App. Total	
07:00 AM	8	79	5	0	92	18	121	67	0	206	3	59	41	0	103	16	32	4	0	52	453
07:15 AM	7	69	19	7	102	24	197	74	1	296	2	113	39	5	159	20	61	6	7	94	651
07:30 AM	8	78	20	1	107	42	207	100	3	352	5	180	50	5	240	13	66	3	4	86	785
07:45 AM	18	95	35	1	149	68	253	124	8	453	10	228	82	3	323	37	53	13	4	107	1032
Total	41	321	79	9	450	152	778	365	12	1307	20	580	212	13	825	86	212	26	15	339	2921
08:00 AM	9	109	16	2	136	71	241	101	6	419	10	269	72	2	353	44	79	14	1	138	1046
08:15 AM	11	113	26	0	150	85	187	90	0	362	15	292	83	1	391	56	65	16	0	137	1040
08:30 AM	23	127	21	0	171	81	186	74	2	343	11	335	92	2	440	33	104	17	1	155	1109
08:45 AM	26	106	25	0	157	82	207	79	2	370	4	357	113	3	477	49	116	20	8	193	1197
Total	69	455	88	2	614	319	821	344	10	1494	40	1253	360	8	1661	182	364	67	10	623	4392
09:00 AM	21	112	14	4	151	79	159	90	0	328	10	318	91	1	420	36	106	25	1	168	1067
09:15 AM	14	132	29	5	180	85	206	96	2	389	21	314	71	2	408	48	87	20	2	157	1134
09:30 AM	16	91	26	6	139	54	229	92	2	377	9	247	103	2	361	63	113	24	3	203	1080
09:45 AM	18	120	24	8	170	59	189	90	6	344	17	219	68	7	311	35	101	25	3	164	989
Total	69	455	93	23	640	277	783	368	10	1438	57	1098	333	12	1500	182	407	94	9	692	4270
Grand Total	179	1231	260	34	1704	748	2382	1077	32	4239	117	2931	905	33	3986	450	983	187	34	1654	11583
Apprch %	10.5	72.2	15.3	2		17.6	56.2	25.4	0.8		2.9	73.5	22.7	0.8		27.2	59.4	11.3	2.1		
Total %	1.5	10.6	2.2	0.3	14.7	6.5	20.6	9.3	0.3	36.6	1	25.3	7.8	0.3	34.4	3.9	8.5	1.6	0.3	14.3	

Start Time	S WOLFE RD Southbound				E EL CAMINO REAL Westbound				S WOLFE RD Northbound				E EL CAMINO REAL Eastbound				Int. Total
	Right	Thru	Left	App. Total	Right	Thru	Left	App. Total	Right	Thru	Left	App. Total	Right	Thru	Left	App. Total	
Peak Hour Analysis From 07:00 AM to 09:45 AM - Peak 1 of 1																	
Peak Hour for Entire Intersection Begins at 08:30 AM																	
08:30 AM	23	127	21	171	81	186	74	341	11	335	92	438	33	104	17	154	1104
08:45 AM	26	106	25	157	82	207	79	368	4	357	113	474	49	116	20	185	1184
09:00 AM	21	112	14	147	79	159	90	328	10	318	91	419	36	106	25	167	1061
09:15 AM	14	132	29	175	85	206	96	387	21	314	71	406	48	87	20	155	1123
Total Volume	84	477	89	650	327	758	339	1424	46	1324	367	1737	166	413	82	661	4472
% App. Total	12.9	73.4	13.7		23	53.2	23.8		2.6	76.2	21.1		25.1	62.5	12.4		
PHF	.808	.903	.767	.929	.962	.915	.883	.920	.548	.927	.812	.916	.847	.890	.820	.893	.944

Traffic Data Service

Campbell, CA
 (408) 377-2988
idsbay@cs.com

File Name : 12AM FINAL
 Site Code : 00000012
 Start Date : 3/31/2015
 Page No : 2

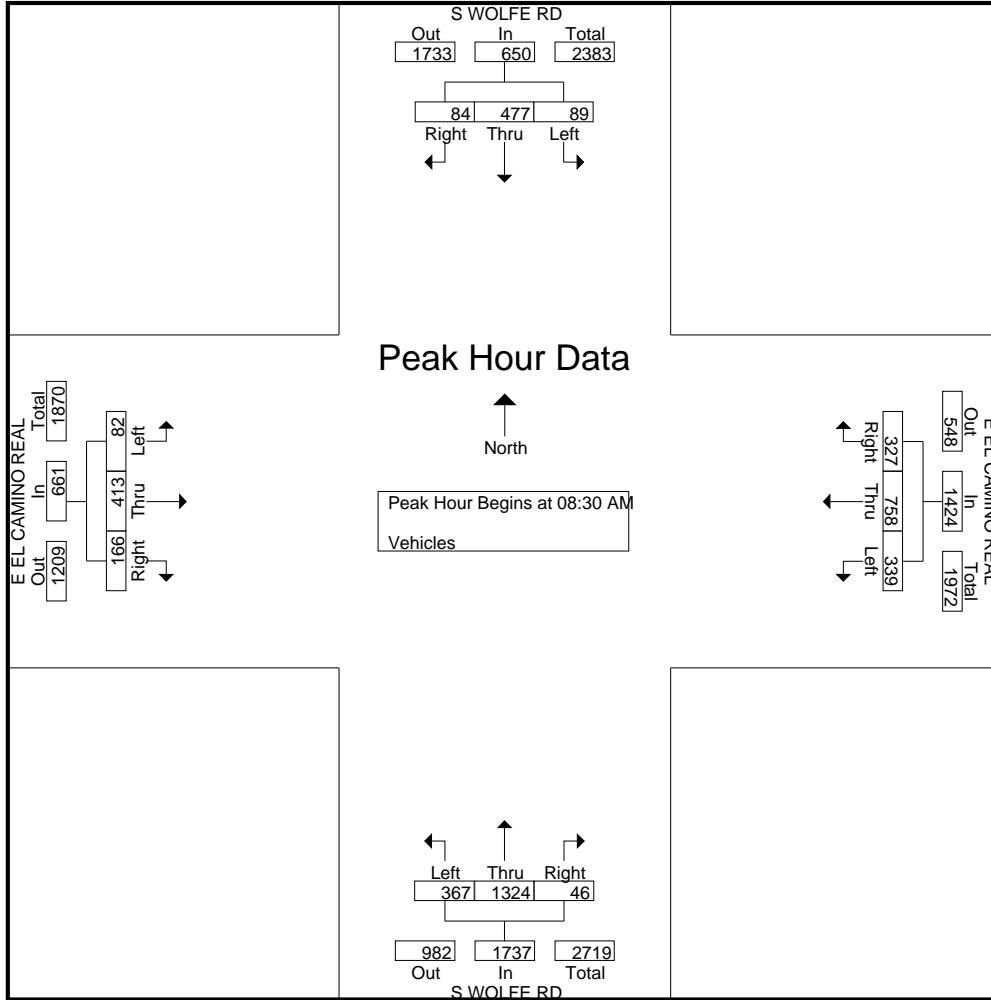

APPENDIX B: INTERSECTION LEVEL OF SERVICE CALCULATIONS



Hamptons Apartment Complex TIA
 SJ15-1612
 Existing AM / Existing PP AM

Summary Scenario Comparison Report (With Average Critical Delay)
 Future Volume Alternative

Intersection	???				Existing AM				Existing PP AM					???				
	LOS	Avg Del (sec)	Crit V/C	Avg Crit Del (sec)	LOS	Avg Del (sec)	Crit V/C	Avg Crit Del (sec)	LOS	Avg Del (sec)	Crit V/C	Crit V/C Change	Avg Crit Del (sec)	Avg Crit Del Change	LOS	Avg Del (sec)	Crit V/C	Avg Crit Del (sec)
#1 Wolfe Road / El Camino Real	?	xx.x	x.xxx	xx.x	D+	35.4	0.644	32.8	D+	35.4	0.646	+ 0.002	32.8	- 0.0	?	xx.x	x.xxx	xx.x
#2 Wolfe Road / Fremont Avenue	?	xx.x	x.xxx	xx.x	C-	34.0	0.630	39.2	C-	34.2	0.636	+ 0.006	39.2	+ 0.0	?	xx.x	x.xxx	xx.x
#3 Wolfe Road / Marion Way	?	xx.x	x.xxx	xx.x	B	15.0	0.518	19.3	B	14.9	0.528	+ 0.010	19.1	- 0.2	?	xx.x	x.xxx	xx.x
#4 Wolfe Road / Inverness Avenue	?	xx.x	x.xxx	xx.x	B	17.9	0.403	15.1	B	17.7	0.413	+ 0.010	14.9	- 0.2	?	xx.x	x.xxx	xx.x
#5 Wolfe Road / Homestead Road	?	xx.x	x.xxx	xx.x	C-	34.0	0.616	32.7	C-	34.2	0.626	+ 0.010	32.7	- 0.0	?	xx.x	x.xxx	xx.x
#6 Wolfe Road / Apple Campus 2	?	xx.x	x.xxx	xx.x	A	0.8	0.304	0.9	A	0.8	0.319	+ 0.015	0.9	+ 0.0	?	xx.x	x.xxx	xx.x
#7 Wolfe Road / Pruneridge Avenue	?	xx.x	x.xxx	xx.x	B-	19.7	0.382	20.0	C	27.8	0.474	+ 0.093	28.0	+ 8.1	?	xx.x	x.xxx	xx.x
#8 Wolfe Road / I-280 NB Ramps	?	xx.x	x.xxx	xx.x	C+	20.8	0.529	23.1	C+	20.9	0.536	+ 0.007	23.2	+ 0.1	?	xx.x	x.xxx	xx.x
#9 Wolfe Road / I-280 SB Ramps	?	xx.x	x.xxx	xx.x	B	17.9	0.461	18.4	B	17.8	0.468	+ 0.007	18.7	+ 0.2	?	xx.x	x.xxx	xx.x
#10 Wolfe Road / Vallco Parkway	?	xx.x	x.xxx	xx.x	C+	21.7	0.457	24.5	C+	21.6	0.461	+ 0.004	24.6	+ 0.2	?	xx.x	x.xxx	xx.x
#11 Wolfe Road / Stevens Creek Boulevard	?	xx.x	x.xxx	xx.x	D	42.0	0.724	43.9	D	42.2	0.730	+ 0.006	44.2	+ 0.3	?	xx.x	x.xxx	xx.x
#12 De Anza Boulevard / Stevens Creek Boulevard	?	xx.x	x.xxx	xx.x	C-	33.2	0.751	33.3	C-	33.4	0.755	+ 0.004	33.6	+ 0.3	?	xx.x	x.xxx	xx.x
#13 Tantau Avenue / Homestead Road	?	xx.x	x.xxx	xx.x	C	28.5	0.654	31.2	C	28.5	0.661	+ 0.007	31.3	+ 0.1	?	xx.x	x.xxx	xx.x
#14 Tantau Avenue / Vallco Parkway	?	xx.x	x.xxx	xx.x	B-	18.6	0.220	15.1	B-	18.7	0.220	+ 0.000	15.1	+ 0.0	?	xx.x	x.xxx	xx.x
#15 Tantau Avenue / Stevens Creek Boulevard	?	xx.x	x.xxx	xx.x	D	39.7	0.589	42.2	D	39.7	0.589	+ 0.000	42.2	- 0.0	?	xx.x	x.xxx	xx.x
#16 Lawrence Expressway / Homestead Road	?	xx.x	x.xxx	xx.x	D	43.3	0.533	50.9	D	43.9	0.538	+ 0.004	52.4	+ 1.5	?	xx.x	x.xxx	xx.x

Hamptons Apartment Complex TIA
SJ15-1612
Existing AM

Level Of Service Computation Report
2000 HCM Operations (Future Volume Alternative)
Existing AM

Intersection #0:

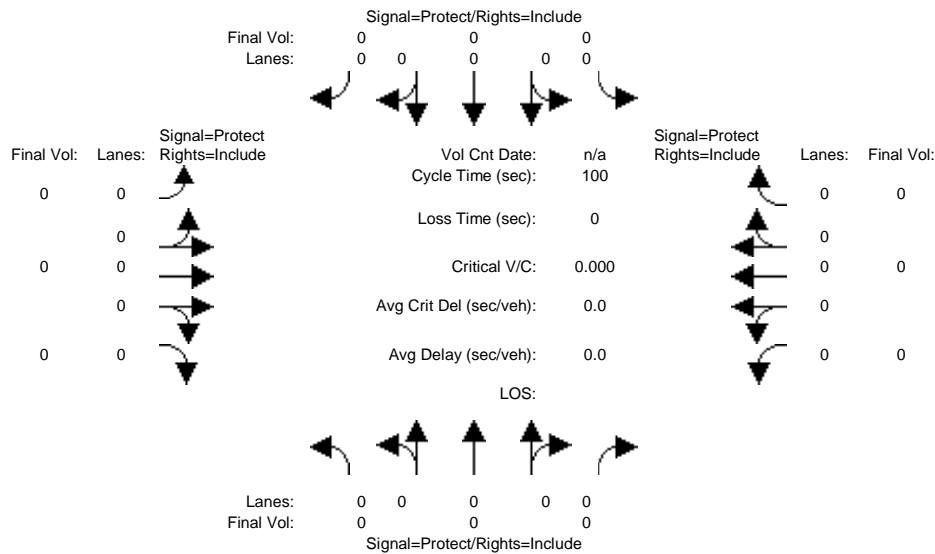

Approach:	North Bound			South Bound			East Bound			West Bound		
	L	T	R	L	T	R	L	T	R	L	T	R
Min. Green:	7	10	10	7	10	10	7	10	10	7	10	10
Y+R:	4.0	4.0	4.0	4.0	4.0	4.0	4.0	4.0	4.0	4.0	4.0	4.0

Volume Module:												
Base Vol:	0	0	0	0	0	0	0	0	0	0	0	0
Growth Adj:	0.00	0.00	0.00	0.00	0.00	0.00	0.00	0.00	0.00	0.00	0.00	0.00
Initial Bse:	0	0	0	0	0	0	0	0	0	0	0	0
Added Vol:	0	0	0	0	0	0	0	0	0	0	0	0
PasserByVol:	0	0	0	0	0	0	0	0	0	0	0	0
Initial Fut:	0	0	0	0	0	0	0	0	0	0	0	0
User Adj:	0.00	0.00	0.00	0.00	0.00	0.00	0.00	0.00	0.00	0.00	0.00	0.00
PHF Adj:	0.00	0.00	0.00	0.00	0.00	0.00	0.00	0.00	0.00	0.00	0.00	0.00
PHF Volume:	0	0	0	0	0	0	0	0	0	0	0	0
Reduct Vol:	0	0	0	0	0	0	0	0	0	0	0	0
Reduced Vol:	0	0	0	0	0	0	0	0	0	0	0	0
PCE Adj:	0.00	0.00	0.00	0.00	0.00	0.00	0.00	0.00	0.00	0.00	0.00	0.00
MLF Adj:	0.00	0.00	0.00	0.00	0.00	0.00	0.00	0.00	0.00	0.00	0.00	0.00
Final Volume:	0	0	0	0	0	0	0	0	0	0	0	0

Saturation Flow Module:												
Sat/Lane:	0	0	0	0	0	0	0	0	0	0	0	0
Adjustment:	1.00	1.00	1.00	1.00	1.00	1.00	1.00	1.00	1.00	1.00	1.00	1.00
Lanes:	0.00	0.00	0.00	0.00	0.00	0.00	0.00	0.00	0.00	0.00	0.00	0.00
Final Sat.:	0	0	0	0	0	0	0	0	0	0	0	0

Capacity Analysis Module:												
Vol/Sat:	0.00	0.00	0.00	0.00	0.00	0.00	0.00	0.00	0.00	0.00	0.00	0.00
Crit Moves:												
Green Time:	0.0	0.0	0.0	0.0	0.0	0.0	0.0	0.0	0.0	0.0	0.0	0.0
Volume/Cap:	0.00	0.00	0.00	0.00	0.00	0.00	0.00	0.00	0.00	0.00	0.00	0.00
Delay/Veh:	0.0	0.0	0.0	0.0	0.0	0.0	0.0	0.0	0.0	0.0	0.0	0.0
User DelAdj:	1.00	1.00	1.00	1.00	1.00	1.00	1.00	1.00	1.00	1.00	1.00	1.00
AdjDel/Veh:	0.0	0.0	0.0	0.0	0.0	0.0	0.0	0.0	0.0	0.0	0.0	0.0
LOS by Move:												
HCM2kAvgQ:	0	0	0	0	0	0	0	0	0	0	0	0

Note: Queue reported is the number of cars per lane.

Hamptons Apartment Complex TIA
 SJ15-1612
 Existing AM

Level Of Service Computation Report
 2000 HCM Operations (Future Volume Alternative)
 Existing PP AM

Intersection #0:

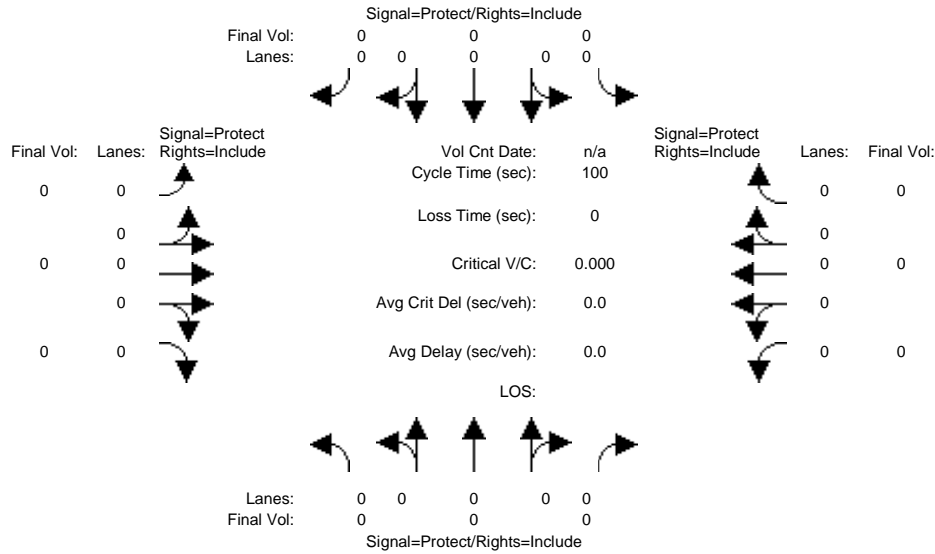

Approach:	North Bound			South Bound			East Bound			West Bound		
	L	T	R	L	T	R	L	T	R	L	T	R
Min. Green:	7	10	10	7	10	10	7	10	10	7	10	10
Y+R:	4.0	4.0	4.0	4.0	4.0	4.0	4.0	4.0	4.0	4.0	4.0	4.0

Volume Module:

Base Vol:	0	0	0	0	0	0	0	0	0	0	0	0
Growth Adj:	0.00	0.00	0.00	0.00	0.00	0.00	0.00	0.00	0.00	0.00	0.00	0.00
Initial Bse:	0	0	0	0	0	0	0	0	0	0	0	0
Added Vol:	0	0	0	0	0	0	0	0	0	0	0	0
PasserByVol:	0	0	0	0	0	0	0	0	0	0	0	0
Initial Fut:	0	0	0	0	0	0	0	0	0	0	0	0
User Adj:	0.00	0.00	0.00	0.00	0.00	0.00	0.00	0.00	0.00	0.00	0.00	0.00
PHF Adj:	0.00	0.00	0.00	0.00	0.00	0.00	0.00	0.00	0.00	0.00	0.00	0.00
PHF Volume:	0	0	0	0	0	0	0	0	0	0	0	0
Reduct Vol:	0	0	0	0	0	0	0	0	0	0	0	0
Reduced Vol:	0	0	0	0	0	0	0	0	0	0	0	0
PCE Adj:	0.00	0.00	0.00	0.00	0.00	0.00	0.00	0.00	0.00	0.00	0.00	0.00
MLF Adj:	0.00	0.00	0.00	0.00	0.00	0.00	0.00	0.00	0.00	0.00	0.00	0.00
FinalVolume:	0	0	0	0	0	0	0	0	0	0	0	0

Saturation Flow Module:

Sat/Lane:	0	0	0	0	0	0	0	0	0	0	0	0
Adjustment:	1.00	1.00	1.00	1.00	1.00	1.00	1.00	1.00	1.00	1.00	1.00	1.00
Lanes:	0.00	0.00	0.00	0.00	0.00	0.00	0.00	0.00	0.00	0.00	0.00	0.00
Final Sat.:	0	0	0	0	0	0	0	0	0	0	0	0

Capacity Analysis Module:

Vol/Sat:	0.00	0.00	0.00	0.00	0.00	0.00	0.00	0.00	0.00	0.00	0.00	0.00
Crit Moves:												
Green Time:	0.0	0.0	0.0	0.0	0.0	0.0	0.0	0.0	0.0	0.0	0.0	0.0
Volume/Cap:	0.00	0.00	0.00	0.00	0.00	0.00	0.00	0.00	0.00	0.00	0.00	0.00
Delay/Veh:	0.0	0.0	0.0	0.0	0.0	0.0	0.0	0.0	0.0	0.0	0.0	0.0
User DelAdj:	1.00	1.00	1.00	1.00	1.00	1.00	1.00	1.00	1.00	1.00	1.00	1.00
AdjDel/Veh:	0.0	0.0	0.0	0.0	0.0	0.0	0.0	0.0	0.0	0.0	0.0	0.0
LOS by Move:												
HCM2kAvgQ:	0	0	0	0	0	0	0	0	0	0	0	0

Note: Queue reported is the number of cars per lane.

Hamptons Apartment Complex TIA
 SJ15-1612
 Existing AM

Level Of Service Computation Report
 2000 HCM Operations (Future Volume Alternative)
 Existing AM

Intersection #1: Wolfe Road / El Camino Real

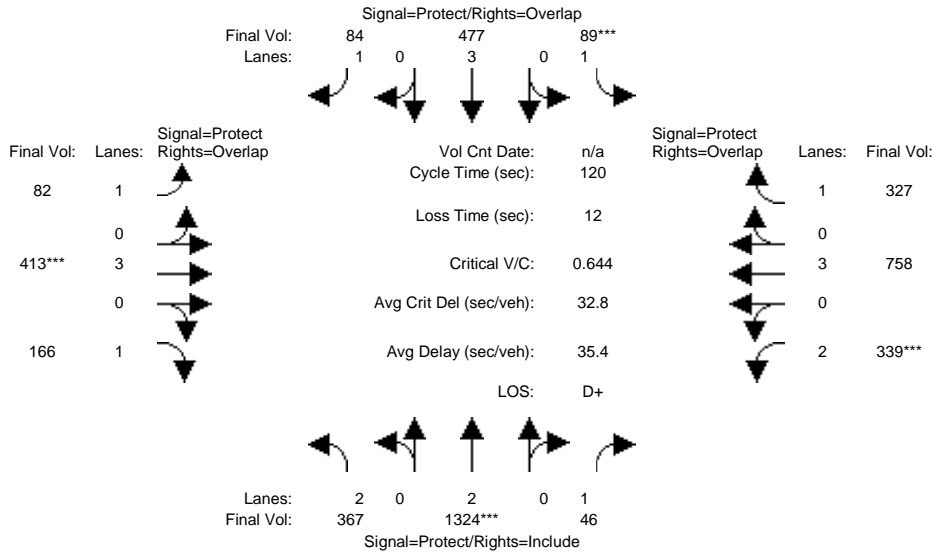

Street Name:	Wolfe Road						El Camino Real					
	North Bound			South Bound			East Bound			West Bound		
Approach:	North Bound			South Bound			East Bound			West Bound		
Movement:	L	T	R	L	T	R	L	T	R	L	T	R
Min. Green:	7	10	10	7	10	10	7	10	10	7	10	10
Y+R:	4.0	4.0	4.0	4.0	4.0	4.0	4.0	4.0	4.0	4.0	4.0	4.0

Volume Module:												
Base Vol:	367	1324	46	89	477	84	82	413	166	339	758	327
Growth Adj:	1.00	1.00	1.00	1.00	1.00	1.00	1.00	1.00	1.00	1.00	1.00	1.00
Initial Bse:	367	1324	46	89	477	84	82	413	166	339	758	327
Added Vol:	0	0	0	0	0	0	0	0	0	0	0	0
PasserByVol:	0	0	0	0	0	0	0	0	0	0	0	0
Initial Fut:	367	1324	46	89	477	84	82	413	166	339	758	327
User Adj:	1.00	1.00	1.00	1.00	1.00	1.00	1.00	1.00	1.00	1.00	1.00	1.00
PHF Adj:	1.00	1.00	1.00	1.00	1.00	1.00	1.00	1.00	1.00	1.00	1.00	1.00
PHF Volume:	367	1324	46	89	477	84	82	413	166	339	758	327
Reduct Vol:	0	0	0	0	0	0	0	0	0	0	0	0
Reduced Vol:	367	1324	46	89	477	84	82	413	166	339	758	327
PCE Adj:	1.00	1.00	1.00	1.00	1.00	1.00	1.00	1.00	1.00	1.00	1.00	1.00
MLF Adj:	1.00	1.00	1.00	1.00	1.00	1.00	1.00	1.00	1.00	1.00	1.00	1.00
Final Volume:	367	1324	46	89	477	84	82	413	166	339	758	327

Saturation Flow Module:												
Sat/Lane:	1900	1900	1900	1900	1900	1900	1900	1900	1900	1900	1900	1900
Adjustment:	0.83	1.00	0.92	0.92	1.00	0.92	0.92	1.00	0.92	0.83	1.00	0.92
Lanes:	2.00	2.00	1.00	1.00	3.00	1.00	1.00	3.00	1.00	2.00	3.00	1.00
Final Sat.:	3150	3800	1750	1750	5700	1750	1750	5700	1750	3150	5700	1750

Capacity Analysis Module:												
Vol/Sat:	0.12	0.35	0.03	0.05	0.08	0.05	0.05	0.07	0.09	0.11	0.13	0.19
Crit Moves:	****			****			****			****		
Green Time:	43.3	65.0	65.0	9.5	31.1	41.2	10.1	13.5	56.8	20.1	23.5	33.0
Volume/Cap:	0.32	0.64	0.05	0.64	0.32	0.14	0.56	0.64	0.20	0.64	0.68	0.68
Delay/Veh:	27.9	20.1	13.0	63.6	36.1	27.3	57.5	53.2	18.5	49.4	46.5	42.7
User DelAdj:	1.00	1.00	1.00	1.00	1.00	1.00	1.00	1.00	1.00	1.00	1.00	1.00
AdjDel/Veh:	27.9	20.1	13.0	63.6	36.1	27.3	57.5	53.2	18.5	49.4	46.5	42.7
LOS by Move:	C	C+	B	E	D+	C	E+	D-	B-	D	D	D
HCM2kAvgQ:	6	17	1	5	5	2	4	6	4	8	10	12

Note: Queue reported is the number of cars per lane.

Hamptons Apartment Complex TIA
SJ15-1612
Existing AM

Level Of Service Computation Report
2000 HCM Operations (Future Volume Alternative)
Existing PP AM

Intersection #1: Wolfe Road / El Camino Real

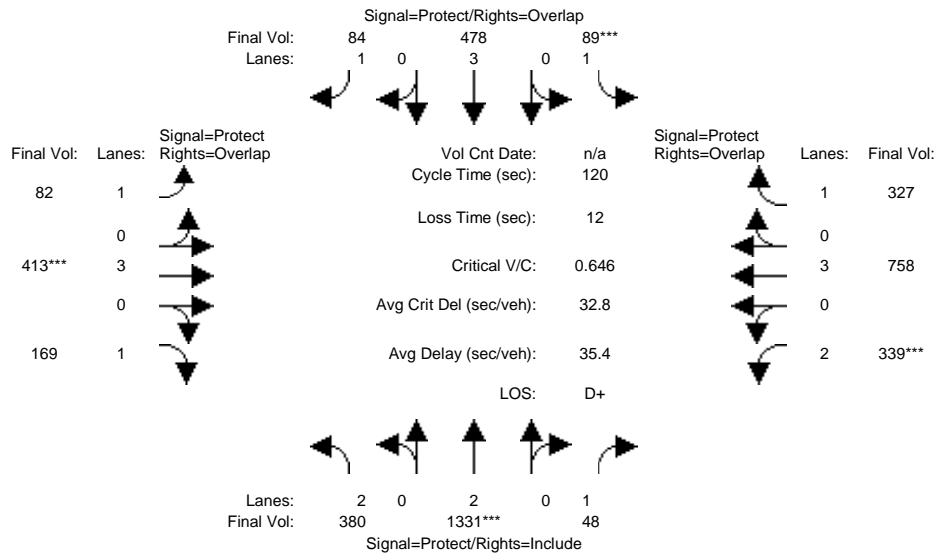

Street Name:	Wolfe Road						El Camino Real					
Approach:	North Bound			South Bound			East Bound			West Bound		
Movement:	L	T	R	L	T	R	L	T	R	L	T	R
Min. Green:	7	10	10	7	10	10	7	10	10	7	10	10
Y+R:	4.0	4.0	4.0	4.0	4.0	4.0	4.0	4.0	4.0	4.0	4.0	4.0

Volume Module:	North Wolfe			South Wolfe			East El Camino			West El Camino		
Base Vol:	367	1324	46	89	477	84	82	413	166	339	758	327
Growth Adj:	1.00	1.00	1.00	1.00	1.00	1.00	1.00	1.00	1.00	1.00	1.00	1.00
Initial Bse:	367	1324	46	89	477	84	82	413	166	339	758	327
Added Vol:	13	7	2	0	1	0	0	0	3	0	0	0
PasserByVol:	0	0	0	0	0	0	0	0	0	0	0	0
Initial Fut:	380	1331	48	89	478	84	82	413	169	339	758	327
User Adj:	1.00	1.00	1.00	1.00	1.00	1.00	1.00	1.00	1.00	1.00	1.00	1.00
PHF Adj:	1.00	1.00	1.00	1.00	1.00	1.00	1.00	1.00	1.00	1.00	1.00	1.00
PHF Volume:	380	1331	48	89	478	84	82	413	169	339	758	327
Reduct Vol:	0	0	0	0	0	0	0	0	0	0	0	0
Reduced Vol:	380	1331	48	89	478	84	82	413	169	339	758	327
PCE Adj:	1.00	1.00	1.00	1.00	1.00	1.00	1.00	1.00	1.00	1.00	1.00	1.00
MLF Adj:	1.00	1.00	1.00	1.00	1.00	1.00	1.00	1.00	1.00	1.00	1.00	1.00
Final Volume:	380	1331	48	89	478	84	82	413	169	339	758	327

Saturation Flow Module:	North Wolfe			South Wolfe			East El Camino			West El Camino		
Sat/Lane:	1900	1900	1900	1900	1900	1900	1900	1900	1900	1900	1900	1900
Adjustment:	0.83	1.00	0.92	0.92	1.00	0.92	0.92	1.00	0.92	0.83	1.00	0.92
Lanes:	2.00	2.00	1.00	1.00	3.00	1.00	1.00	3.00	1.00	2.00	3.00	1.00
Final Sat.:	3150	3800	1750	1750	5700	1750	1750	5700	1750	3150	5700	1750

Capacity Analysis Module:	North Wolfe			South Wolfe			East El Camino			West El Camino		
Vol/Sat:	0.12	0.35	0.03	0.05	0.08	0.05	0.05	0.07	0.10	0.11	0.13	0.19
Crit Moves:	****			****			****			****		
Green Time:	44.0	65.1	65.1	9.5	30.6	40.6	10.0	13.5	57.4	20.0	23.4	32.9
Volume/Cap:	0.33	0.65	0.05	0.65	0.33	0.14	0.56	0.65	0.20	0.65	0.68	0.68
Delay/Veh:	27.6	20.1	12.9	63.8	36.5	27.7	57.7	53.3	18.2	49.5	46.6	42.9
User DelAdj:	1.00	1.00	1.00	1.00	1.00	1.00	1.00	1.00	1.00	1.00	1.00	1.00
AdjDel/Veh:	27.6	20.1	12.9	63.8	36.5	27.7	57.7	53.3	18.2	49.5	46.6	42.9
LOS by Move:	C	C+	B	E	D+	C	E+	D-	B-	D	D	D
HCM2kAvgQ:	6	17	1	5	5	2	4	6	4	8	10	13

Note: Queue reported is the number of cars per lane.

Hamptons Apartment Complex TIA
 SJ15-1612
 Existing AM

Level Of Service Computation Report
 2000 HCM Operations (Future Volume Alternative)
 Existing AM

Intersection #2: Wolfe Road / Fremont Avenue

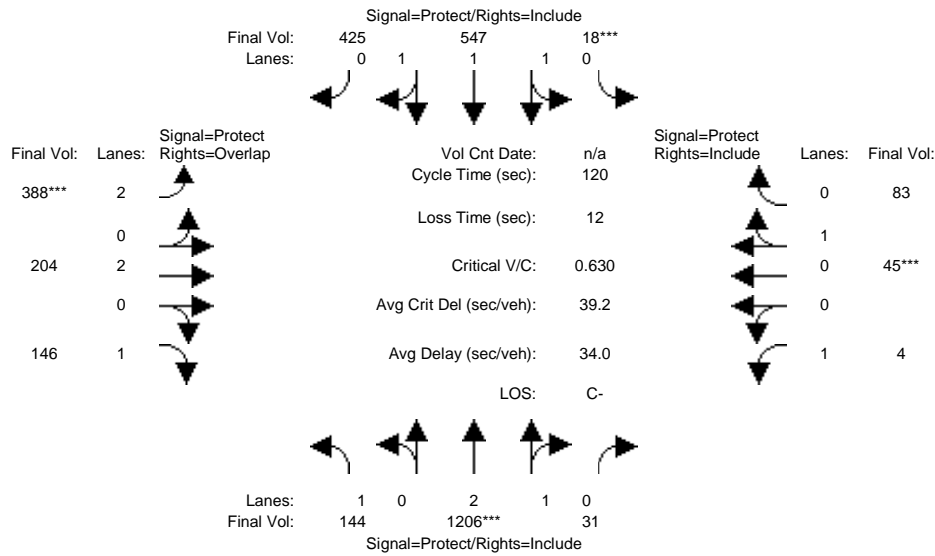

Street Name:	Wolfe Road						Fremont Avenue					
Approach:	North Bound			South Bound			East Bound			West Bound		
Movement:	L	T	R	L	T	R	L	T	R	L	T	R
Min. Green:	7	10	10	7	10	10	7	10	10	7	10	10
Y+R:	4.0	4.0	4.0	4.0	4.0	4.0	4.0	4.0	4.0	4.0	4.0	4.0

Volume Module:	North Bound			South Bound			East Bound			West Bound		
Base Vol:	144	1206	31	18	547	425	388	204	146	4	45	83
Growth Adj:	1.00	1.00	1.00	1.00	1.00	1.00	1.00	1.00	1.00	1.00	1.00	1.00
Initial Bse:	144	1206	31	18	547	425	388	204	146	4	45	83
Added Vol:	0	0	0	0	0	0	0	0	0	0	0	0
PasserByVol:	0	0	0	0	0	0	0	0	0	0	0	0
Initial Fut:	144	1206	31	18	547	425	388	204	146	4	45	83
User Adj:	1.00	1.00	1.00	1.00	1.00	1.00	1.00	1.00	1.00	1.00	1.00	1.00
PHF Adj:	1.00	1.00	1.00	1.00	1.00	1.00	1.00	1.00	1.00	1.00	1.00	1.00
PHF Volume:	144	1206	31	18	547	425	388	204	146	4	45	83
Reduct Vol:	0	0	0	0	0	0	0	0	0	0	0	0
Reduced Vol:	144	1206	31	18	547	425	388	204	146	4	45	83
PCE Adj:	1.00	1.00	1.00	1.00	1.00	1.00	1.00	1.00	1.00	1.00	1.00	1.00
MLF Adj:	1.00	1.00	1.00	1.00	1.00	1.00	1.00	1.00	1.00	1.00	1.00	1.00
Final Volume:	144	1206	31	18	547	425	388	204	146	4	45	83

Saturation Flow Module:	North Bound			South Bound			East Bound			West Bound		
Sat/Lane:	1900	1900	1900	1900	1900	1900	1900	1900	1900	1900	1900	1900
Adjustment:	0.92	0.98	0.95	0.95	0.98	0.95	0.83	1.00	0.92	0.92	0.95	0.95
Lanes:	1.00	2.92	0.08	0.07	1.93	1.00	2.00	2.00	1.00	1.00	0.35	0.65
Final Sat.:	1750	5459	140	118	3598	1800	3150	3800	1750	1750	633	1167

Capacity Analysis Module:	North Bound			South Bound			East Bound			West Bound		
Vol/Sat:	0.08	0.22	0.22	0.15	0.15	0.24	0.12	0.05	0.08	0.00	0.07	0.07
Crit Moves:	****			****			****			****		
Green Time:	18.4	42.1	42.1	28.9	52.7	52.7	23.5	21.8	40.1	15.2	13.5	13.5
Volume/Cap:	0.54	0.63	0.63	0.63	0.35	0.54	0.63	0.30	0.25	0.02	0.63	0.63
Delay/Veh:	49.1	33.2	33.2	41.6	22.4	25.1	46.4	42.7	29.2	45.9	57.1	57.1
User DelAdj:	1.00	1.00	1.00	1.00	1.00	1.00	1.00	1.00	1.00	1.00	1.00	1.00
AdjDel/Veh:	49.1	33.2	33.2	41.6	22.4	25.1	46.4	42.7	29.2	45.9	57.1	57.1
LOS by Move:	D	C-	C-	D	C+	C	D	D	C	D	E+	E+
HCM2kAvgQ:	5	13	13	9	7	12	9	3	4	0	6	6

Note: Queue reported is the number of cars per lane.

Hamptons Apartment Complex TIA
SJ15-1612
Existing AM

Level Of Service Computation Report
2000 HCM Operations (Future Volume Alternative)
Existing PP AM

Intersection #2: Wolfe Road / Fremont Avenue

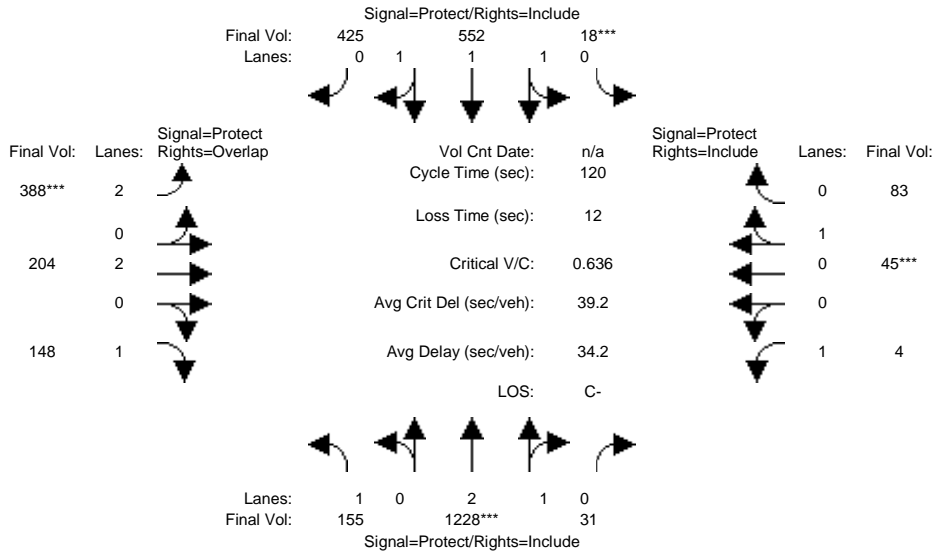

Street Name:	Wolfe Road						Fremont Avenue					
	North Bound			South Bound			East Bound			West Bound		
Approach:	L	T	R	L	T	R	L	T	R	L	T	R
Min. Green:	7	10	10	7	10	10	7	10	10	7	10	10
Y+R:	4.0	4.0	4.0	4.0	4.0	4.0	4.0	4.0	4.0	4.0	4.0	4.0

Volume Module:												
Base Vol:	144	1206	31	18	547	425	388	204	146	4	45	83
Growth Adj:	1.00	1.00	1.00	1.00	1.00	1.00	1.00	1.00	1.00	1.00	1.00	1.00
Initial Bse:	144	1206	31	18	547	425	388	204	146	4	45	83
Added Vol:	11	22	0	0	5	0	0	0	2	0	0	0
PasserByVol:	0	0	0	0	0	0	0	0	0	0	0	0
Initial Fut:	155	1228	31	18	552	425	388	204	148	4	45	83
User Adj:	1.00	1.00	1.00	1.00	1.00	1.00	1.00	1.00	1.00	1.00	1.00	1.00
PHF Adj:	1.00	1.00	1.00	1.00	1.00	1.00	1.00	1.00	1.00	1.00	1.00	1.00
PHF Volume:	155	1228	31	18	552	425	388	204	148	4	45	83
Reduct Vol:	0	0	0	0	0	0	0	0	0	0	0	0
Reduced Vol:	155	1228	31	18	552	425	388	204	148	4	45	83
PCE Adj:	1.00	1.00	1.00	1.00	1.00	1.00	1.00	1.00	1.00	1.00	1.00	1.00
MLF Adj:	1.00	1.00	1.00	1.00	1.00	1.00	1.00	1.00	1.00	1.00	1.00	1.00
Final Volume:	155	1228	31	18	552	425	388	204	148	4	45	83

Saturation Flow Module:												
Sat/Lane:	1900	1900	1900	1900	1900	1900	1900	1900	1900	1900	1900	1900
Adjustment:	0.92	0.98	0.95	0.95	0.98	0.95	0.83	1.00	0.92	0.92	0.95	0.95
Lanes:	1.00	2.92	0.08	0.07	1.93	1.00	2.00	2.00	1.00	1.00	0.35	0.65
Final Sat.:	1750	5462	138	117	3599	1800	3150	3800	1750	1750	633	1167

Capacity Analysis Module:												
Vol/Sat:	0.09	0.22	0.22	0.15	0.15	0.24	0.12	0.05	0.08	0.00	0.07	0.07
Crit Moves:	****		****				****			****		
Green Time:	19.5	42.4	42.4	28.9	51.9	51.9	23.2	21.6	41.0	15.1	13.4	13.4
Volume/Cap:	0.55	0.64	0.64	0.64	0.35	0.55	0.64	0.30	0.25	0.02	0.64	0.64
Delay/Veh:	48.4	33.0	33.0	41.7	22.9	25.7	46.7	42.9	28.6	46.0	57.5	57.5
User DelAdj:	1.00	1.00	1.00	1.00	1.00	1.00	1.00	1.00	1.00	1.00	1.00	1.00
AdjDel/Veh:	48.4	33.0	33.0	41.7	22.9	25.7	46.7	42.9	28.6	46.0	57.5	57.5
LOS by Move:	D	C-	C-	D	C+	C	D	D	C	D	E+	E+
HCM2kAvgQ:	6	13	13	10	7	12	9	3	4	0	6	6

Note: Queue reported is the number of cars per lane.

Hamptons Apartment Complex TIA
 SJ15-1612
 Existing AM

Level Of Service Computation Report
 2000 HCM Operations (Future Volume Alternative)
 Existing AM

Intersection #3: Wolfe Road / Marion Way

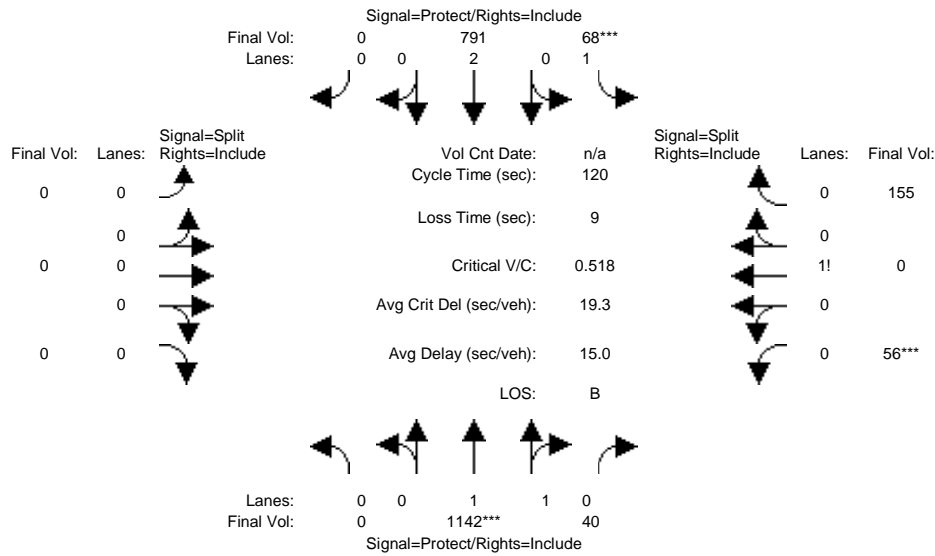

Street Name:	Wolfe Road						Marion Way					
	North Bound			South Bound			East Bound			West Bound		
Approach:	L	T	R	L	T	R	L	T	R	L	T	R
Min. Green:	7	10	10	7	10	10	0	0	0	10	10	10
Y+R:	4.0	4.0	4.0	4.0	4.0	4.0	4.0	4.0	4.0	4.0	4.0	4.0

Volume Module:												
Base Vol:	0	1142	40	68	791	0	0	0	0	56	0	155
Growth Adj:	1.00	1.00	1.00	1.00	1.00	1.00	1.00	1.00	1.00	1.00	1.00	1.00
Initial Bse:	0	1142	40	68	791	0	0	0	0	56	0	155
Added Vol:	0	0	0	0	0	0	0	0	0	0	0	0
PasserByVol:	0	0	0	0	0	0	0	0	0	0	0	0
Initial Fut:	0	1142	40	68	791	0	0	0	0	56	0	155
User Adj:	1.00	1.00	1.00	1.00	1.00	1.00	1.00	1.00	1.00	1.00	1.00	1.00
PHF Adj:	1.00	1.00	1.00	1.00	1.00	1.00	1.00	1.00	1.00	1.00	1.00	1.00
PHF Volume:	0	1142	40	68	791	0	0	0	0	56	0	155
Reduct Vol:	0	0	0	0	0	0	0	0	0	0	0	0
Reduced Vol:	0	1142	40	68	791	0	0	0	0	56	0	155
PCE Adj:	1.00	1.00	1.00	1.00	1.00	1.00	1.00	1.00	1.00	1.00	1.00	1.00
MLF Adj:	1.00	1.00	1.00	1.00	1.00	1.00	1.00	1.00	1.00	1.00	1.00	1.00
Final Volume:	0	1142	40	68	791	0	0	0	0	56	0	155

Saturation Flow Module:												
Sat/Lane:	1900	1900	1900	1900	1900	1900	1900	1900	1900	1900	1900	1900
Adjustment:	0.92	0.97	0.95	0.92	1.00	0.92	0.92	1.00	0.92	0.92	0.92	0.92
Lanes:	0.00	1.93	0.07	1.00	2.00	0.00	0.00	0.00	0.00	0.27	0.00	0.73
Final Sat.:	0	3575	125	1750	3800	0	0	0	0	464	0	1286

Capacity Analysis Module:												
Vol/Sat:	0.00	0.32	0.32	0.04	0.21	0.00	0.00	0.00	0.00	0.12	0.00	0.12
Crit Moves:	****			****						****		
Green Time:	0.0	74.0	74.0	9.0	83.1	0.0	0.0	0.0	0.0	27.9	0.0	27.9
Volume/Cap:	0.00	0.52	0.52	0.52	0.30	0.00	0.00	0.00	0.00	0.52	0.00	0.52
Delay/Veh:	0.0	13.1	13.1	57.0	7.2	0.0	0.0	0.0	0.0	41.3	0.0	41.3
User DelAdj:	1.00	1.00	1.00	1.00	1.00	1.00	1.00	1.00	1.00	1.00	1.00	1.00
AdjDel/Veh:	0.0	13.1	13.1	57.0	7.2	0.0	0.0	0.0	0.0	41.3	0.0	41.3
LOS by Move:	A	B	B	E+	A	A	A	A	A	D	A	D
HCM2kAvgQ:	0	12	12	3	6	0	0	0	0	8	0	8

Note: Queue reported is the number of cars per lane.

Hamptons Apartment Complex TIA
 SJ15-1612
 Existing AM

Level Of Service Computation Report
 2000 HCM Operations (Future Volume Alternative)
 Existing PP AM

Intersection #3: Wolfe Road / Marion Way

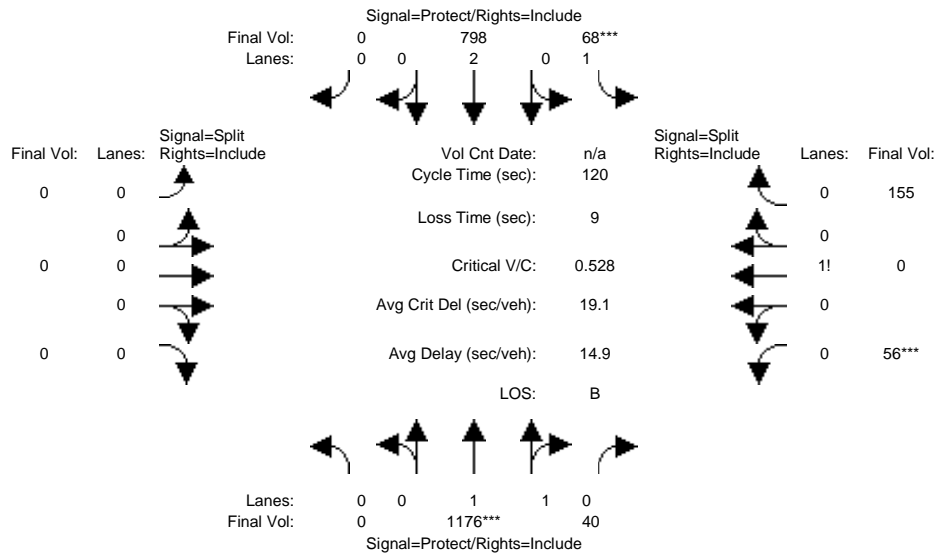

Street Name:	Wolfe Road						Marion Way					
	North Bound			South Bound			East Bound			West Bound		
Approach:	L	T	R	L	T	R	L	T	R	L	T	R
Min. Green:	7	10	10	7	10	10	0	0	0	10	10	10
Y+R:	4.0	4.0	4.0	4.0	4.0	4.0	4.0	4.0	4.0	4.0	4.0	4.0

Volume Module:												
Base Vol:	0	1142	40	68	791	0	0	0	0	56	0	155
Growth Adj:	1.00	1.00	1.00	1.00	1.00	1.00	1.00	1.00	1.00	1.00	1.00	1.00
Initial Bse:	0	1142	40	68	791	0	0	0	0	56	0	155
Added Vol:	0	34	0	0	7	0	0	0	0	0	0	0
PasserByVol:	0	0	0	0	0	0	0	0	0	0	0	0
Initial Fut:	0	1176	40	68	798	0	0	0	0	56	0	155
User Adj:	1.00	1.00	1.00	1.00	1.00	1.00	1.00	1.00	1.00	1.00	1.00	1.00
PHF Adj:	1.00	1.00	1.00	1.00	1.00	1.00	1.00	1.00	1.00	1.00	1.00	1.00
PHF Volume:	0	1176	40	68	798	0	0	0	0	56	0	155
Reduct Vol:	0	0	0	0	0	0	0	0	0	0	0	0
Reduced Vol:	0	1176	40	68	798	0	0	0	0	56	0	155
PCE Adj:	1.00	1.00	1.00	1.00	1.00	1.00	1.00	1.00	1.00	1.00	1.00	1.00
MLF Adj:	1.00	1.00	1.00	1.00	1.00	1.00	1.00	1.00	1.00	1.00	1.00	1.00
Final Volume:	0	1176	40	68	798	0	0	0	0	56	0	155

Saturation Flow Module:												
Sat/Lane:	1900	1900	1900	1900	1900	1900	1900	1900	1900	1900	1900	1900
Adjustment:	0.92	0.97	0.95	0.92	1.00	0.92	0.92	1.00	0.92	0.92	0.92	0.92
Lanes:	0.00	1.93	0.07	1.00	2.00	0.00	0.00	0.00	0.00	0.27	0.00	0.73
Final Sat.:	0	3578	122	1750	3800	0	0	0	0	464	0	1286

Capacity Analysis Module:												
Vol/Sat:	0.00	0.33	0.33	0.04	0.21	0.00	0.00	0.00	0.00	0.12	0.00	0.12
Crit Moves:	****			****						****		
Green Time:	0.0	74.7	74.7	8.8	83.6	0.0	0.0	0.0	0.0	27.4	0.0	27.4
Volume/Cap:	0.00	0.53	0.53	0.53	0.30	0.00	0.00	0.00	0.00	0.53	0.00	0.53
Delay/Veh:	0.0	12.9	12.9	57.6	7.1	0.0	0.0	0.0	0.0	41.9	0.0	41.9
User DelAdj:	1.00	1.00	1.00	1.00	1.00	1.00	1.00	1.00	1.00	1.00	1.00	1.00
AdjDel/Veh:	0.0	12.9	12.9	57.6	7.1	0.0	0.0	0.0	0.0	41.9	0.0	41.9
LOS by Move:	A	B	B	E+	A	A	A	A	A	D	A	D
HCM2kAvgQ:	0	13	13	3	6	0	0	0	0	8	0	8

Note: Queue reported is the number of cars per lane.

Hamptons Apartment Complex TIA
 SJ15-1612
 Existing AM

Level Of Service Computation Report
 2000 HCM Operations (Future Volume Alternative)
 Existing AM

Intersection #4: Wolfe Road / Inverness Avenue

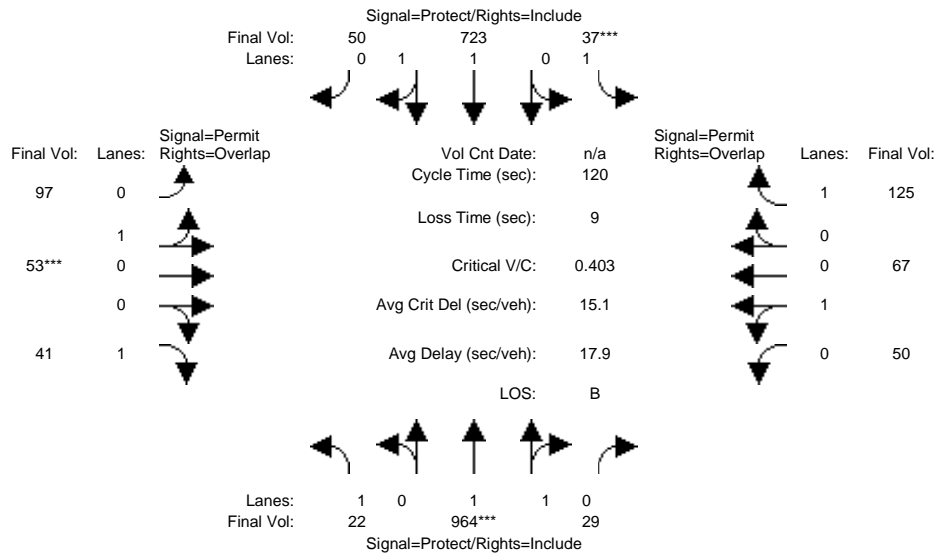

Street Name:	Wolfe Road						Inverness Avenue					
	North Bound			South Bound			East Bound			West Bound		
Approach:	North Bound			South Bound			East Bound			West Bound		
Movement:	L	T	R	L	T	R	L	T	R	L	T	R
Min. Green:	7	10	10	7	10	10	10	10	10	10	10	10
Y+R:	4.0	4.0	4.0	4.0	4.0	4.0	4.0	4.0	4.0	4.0	4.0	4.0

Volume Module:												
Base Vol:	22	964	29	37	723	50	97	53	41	50	67	125
Growth Adj:	1.00	1.00	1.00	1.00	1.00	1.00	1.00	1.00	1.00	1.00	1.00	1.00
Initial Bse:	22	964	29	37	723	50	97	53	41	50	67	125
Added Vol:	0	0	0	0	0	0	0	0	0	0	0	0
PasserByVol:	0	0	0	0	0	0	0	0	0	0	0	0
Initial Fut:	22	964	29	37	723	50	97	53	41	50	67	125
User Adj:	1.00	1.00	1.00	1.00	1.00	1.00	1.00	1.00	1.00	1.00	1.00	1.00
PHF Adj:	1.00	1.00	1.00	1.00	1.00	1.00	1.00	1.00	1.00	1.00	1.00	1.00
PHF Volume:	22	964	29	37	723	50	97	53	41	50	67	125
Reduct Vol:	0	0	0	0	0	0	0	0	0	0	0	0
Reduced Vol:	22	964	29	37	723	50	97	53	41	50	67	125
PCE Adj:	1.00	1.00	1.00	1.00	1.00	1.00	1.00	1.00	1.00	1.00	1.00	1.00
MLF Adj:	1.00	1.00	1.00	1.00	1.00	1.00	1.00	1.00	1.00	1.00	1.00	1.00
Final Volume:	22	964	29	37	723	50	97	53	41	50	67	125

Saturation Flow Module:												
Sat/Lane:	1900	1900	1900	1900	1900	1900	1900	1900	1900	1900	1900	1900
Adjustment:	0.92	0.97	0.95	0.92	0.98	0.95	0.95	0.95	0.92	0.95	0.95	0.92
Lanes:	1.00	1.94	0.06	1.00	1.87	0.13	0.65	0.35	1.00	0.43	0.57	1.00
Final Sat.:	1750	3592	108	1750	3460	239	1164	636	1750	769	1031	1750

Capacity Analysis Module:												
Vol/Sat:	0.01	0.27	0.27	0.02	0.21	0.21	0.08	0.08	0.02	0.07	0.07	0.07
Crit Moves:	****			****			****			****		
Green Time:	18.8	79.4	79.4	7.0	67.5	67.5	24.6	24.6	43.5	24.6	24.6	31.6
Volume/Cap:	0.08	0.41	0.41	0.36	0.37	0.37	0.41	0.41	0.06	0.32	0.32	0.27
Delay/Veh:	43.3	9.5	9.5	56.5	14.6	14.6	42.1	42.1	25.0	41.0	41.0	35.4
User DelAdj:	1.00	1.00	1.00	1.00	1.00	1.00	1.00	1.00	1.00	1.00	1.00	1.00
AdjDel/Veh:	43.3	9.5	9.5	56.5	14.6	14.6	42.1	42.1	25.0	41.0	41.0	35.4
LOS by Move:	D	A	A	E+	B	B	D	D	C	D	D	D+
HCM2kAvgQ:	1	8	8	1	8	8	5	5	1	4	4	4

Note: Queue reported is the number of cars per lane.

Hamptons Apartment Complex TIA
 SJ15-1612
 Existing AM

Level Of Service Computation Report
 2000 HCM Operations (Future Volume Alternative)
 Existing PP AM

Intersection #4: Wolfe Road / Inverness Avenue

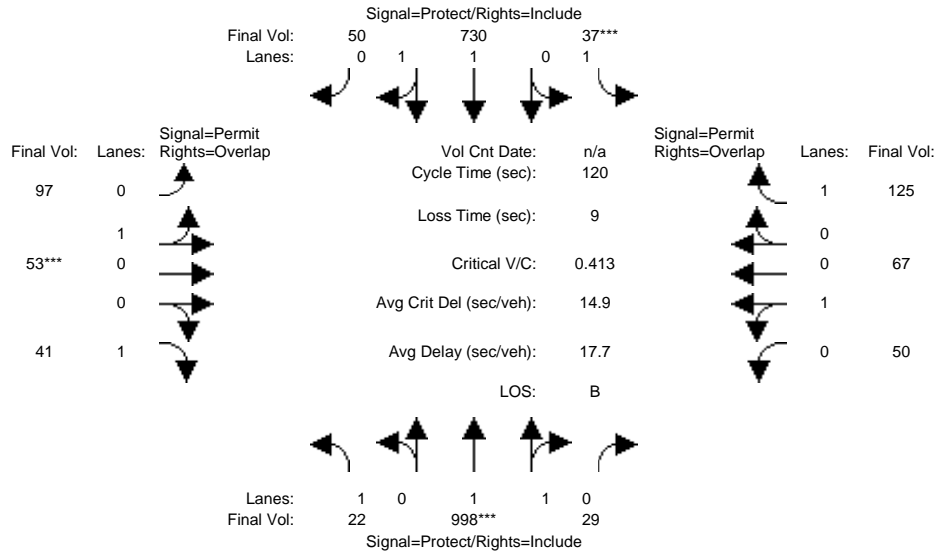

Street Name:	Wolfe Road						Inverness Avenue					
	North Bound			South Bound			East Bound			West Bound		
Approach:	L	T	R	L	T	R	L	T	R	L	T	R
Min. Green:	7	10	10	7	10	10	10	10	10	10	10	10
Y+R:	4.0	4.0	4.0	4.0	4.0	4.0	4.0	4.0	4.0	4.0	4.0	4.0

Volume Module:												
Base Vol:	22	964	29	37	723	50	97	53	41	50	67	125
Growth Adj:	1.00	1.00	1.00	1.00	1.00	1.00	1.00	1.00	1.00	1.00	1.00	1.00
Initial Bse:	22	964	29	37	723	50	97	53	41	50	67	125
Added Vol:	0	34	0	0	7	0	0	0	0	0	0	0
PasserByVol:	0	0	0	0	0	0	0	0	0	0	0	0
Initial Fut:	22	998	29	37	730	50	97	53	41	50	67	125
User Adj:	1.00	1.00	1.00	1.00	1.00	1.00	1.00	1.00	1.00	1.00	1.00	1.00
PHF Adj:	1.00	1.00	1.00	1.00	1.00	1.00	1.00	1.00	1.00	1.00	1.00	1.00
PHF Volume:	22	998	29	37	730	50	97	53	41	50	67	125
Reduct Vol:	0	0	0	0	0	0	0	0	0	0	0	0
Reduced Vol:	22	998	29	37	730	50	97	53	41	50	67	125
PCE Adj:	1.00	1.00	1.00	1.00	1.00	1.00	1.00	1.00	1.00	1.00	1.00	1.00
MLF Adj:	1.00	1.00	1.00	1.00	1.00	1.00	1.00	1.00	1.00	1.00	1.00	1.00
Final Volume:	22	998	29	37	730	50	97	53	41	50	67	125

Saturation Flow Module:												
Sat/Lane:	1900	1900	1900	1900	1900	1900	1900	1900	1900	1900	1900	1900
Adjustment:	0.92	0.97	0.95	0.92	0.98	0.95	0.95	0.95	0.92	0.95	0.95	0.92
Lanes:	1.00	1.94	0.06	1.00	1.87	0.13	0.65	0.35	1.00	0.43	0.57	1.00
Final Sat.:	1750	3595	104	1750	3463	237	1164	636	1750	769	1031	1750

Capacity Analysis Module:												
Vol/Sat:	0.01	0.28	0.28	0.02	0.21	0.21	0.08	0.08	0.02	0.07	0.07	0.07
Crit Moves:	****			****			****			****		
Green Time:	18.9	80.0	80.0	7.0	68.1	68.1	24.0	24.0	42.9	24.0	24.0	31.0
Volume/Cap:	0.08	0.42	0.42	0.36	0.37	0.37	0.42	0.42	0.07	0.32	0.32	0.28
Delay/Veh:	43.3	9.3	9.3	56.5	14.3	14.3	42.7	42.7	25.4	41.6	41.6	35.9
User DelAdj:	1.00	1.00	1.00	1.00	1.00	1.00	1.00	1.00	1.00	1.00	1.00	1.00
AdjDel/Veh:	43.3	9.3	9.3	56.5	14.3	14.3	42.7	42.7	25.4	41.6	41.6	35.9
LOS by Move:	D	A	A	E+	B	B	D	D	C	D	D	D+
HCM2kAvgQ:	1	9	9	1	8	8	5	5	1	4	4	4

Note: Queue reported is the number of cars per lane.

Hamptons Apartment Complex TIA
 SJ15-1612
 Existing AM

Level Of Service Computation Report
 2000 HCM Operations (Future Volume Alternative)
 Existing AM

Intersection #5: Wolfe Road / Homestead Road

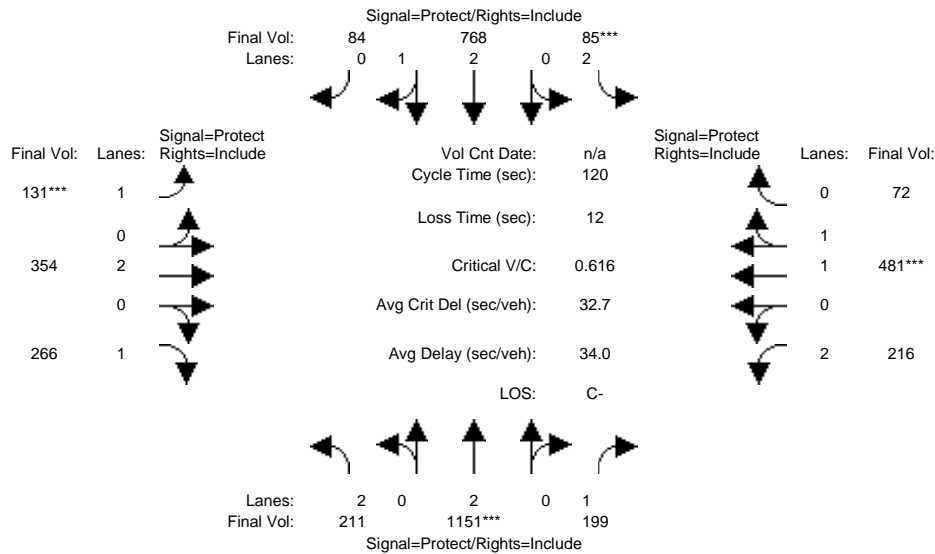

Street Name:	Wolfe Road						Homestead Road					
	North Bound			South Bound			East Bound			West Bound		
Approach:	L	T	R	L	T	R	L	T	R	L	T	R
Min. Green:	7	10	10	7	10	10	10	10	10	10	10	10
Y+R:	4.0	4.0	4.0	4.0	4.0	4.0	4.0	4.0	4.0	4.0	4.0	4.0

Volume Module:												
Base Vol:	211	1151	199	85	768	84	131	354	266	216	481	72
Growth Adj:	1.00	1.00	1.00	1.00	1.00	1.00	1.00	1.00	1.00	1.00	1.00	1.00
Initial Bse:	211	1151	199	85	768	84	131	354	266	216	481	72
Added Vol:	0	0	0	0	0	0	0	0	0	0	0	0
PasserByVol:	0	0	0	0	0	0	0	0	0	0	0	0
Initial Fut:	211	1151	199	85	768	84	131	354	266	216	481	72
User Adj:	1.00	1.00	1.00	1.00	1.00	1.00	1.00	1.00	1.00	1.00	1.00	1.00
PHF Adj:	1.00	1.00	1.00	1.00	1.00	1.00	1.00	1.00	1.00	1.00	1.00	1.00
PHF Volume:	211	1151	199	85	768	84	131	354	266	216	481	72
Reduct Vol:	0	0	0	0	0	0	0	0	0	0	0	0
Reduced Vol:	211	1151	199	85	768	84	131	354	266	216	481	72
PCE Adj:	1.00	1.00	1.00	1.00	1.00	1.00	1.00	1.00	1.00	1.00	1.00	1.00
MLF Adj:	1.00	1.00	1.00	1.00	1.00	1.00	1.00	1.00	1.00	1.00	1.00	1.00
Final Volume:	211	1151	199	85	768	84	131	354	266	216	481	72

Saturation Flow Module:												
Sat/Lane:	1900	1900	1900	1900	1900	1900	1900	1900	1900	1900	1900	1900
Adjustment:	0.83	1.00	0.92	0.83	0.99	0.95	0.92	1.00	0.92	0.83	0.98	0.95
Lanes:	2.00	2.00	1.00	2.00	2.69	0.31	1.00	2.00	1.00	2.00	1.73	0.27
Final Sat.:	3150	3800	1750	3150	5047	552	1750	3800	1750	3150	3218	482

Capacity Analysis Module:												
Vol/Sat:	0.07	0.30	0.11	0.03	0.15	0.15	0.07	0.09	0.15	0.07	0.15	0.15
Crit Moves:	****			****			****			****		
Green Time:	19.9	58.0	58.0	7.0	45.1	45.1	14.3	27.8	27.8	15.2	28.6	28.6
Volume/Cap:	0.40	0.63	0.24	0.46	0.40	0.40	0.63	0.40	0.66	0.54	0.63	0.63
Delay/Veh:	45.3	23.6	18.2	56.5	27.7	27.7	56.2	39.4	45.7	50.6	42.3	42.3
User DelAdj:	1.00	1.00	1.00	1.00	1.00	1.00	1.00	1.00	1.00	1.00	1.00	1.00
AdjDel/Veh:	45.3	23.6	18.2	56.5	27.7	27.7	56.2	39.4	45.7	50.6	42.3	42.3
LOS by Move:	D	C	B-	E+	C	C	E+	D	D	D	D	D
HCM2kAvgQ:	4	15	4	2	8	8	6	6	10	4	9	9

Note: Queue reported is the number of cars per lane.

Hamptons Apartment Complex TIA
 SJ15-1612
 Existing AM

Level Of Service Computation Report
 2000 HCM Operations (Future Volume Alternative)
 Existing PP AM

Intersection #5: Wolfe Road / Homestead Road

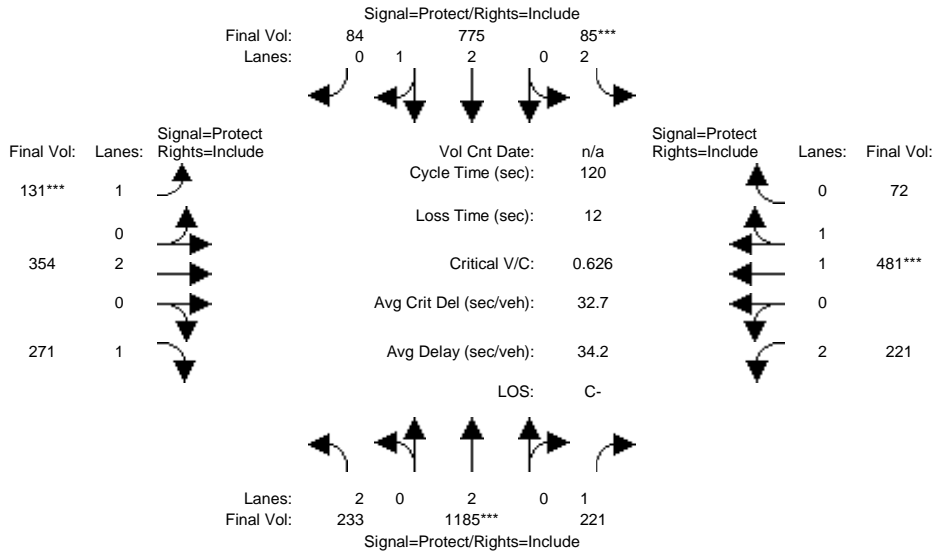

Street Name:	Wolfe Road						Homestead Road					
	North Bound			South Bound			East Bound			West Bound		
Approach:	North Bound			South Bound			East Bound			West Bound		
Movement:	L	T	R	L	T	R	L	T	R	L	T	R
Min. Green:	7	10	10	7	10	10	10	10	10	10	10	10
Y+R:	4.0	4.0	4.0	4.0	4.0	4.0	4.0	4.0	4.0	4.0	4.0	4.0

Volume Module:												
Base Vol:	211	1151	199	85	768	84	131	354	266	216	481	72
Growth Adj:	1.00	1.00	1.00	1.00	1.00	1.00	1.00	1.00	1.00	1.00	1.00	1.00
Initial Bse:	211	1151	199	85	768	84	131	354	266	216	481	72
Added Vol:	22	34	22	0	7	0	0	0	5	5	0	0
PasserByVol:	0	0	0	0	0	0	0	0	0	0	0	0
Initial Fut:	233	1185	221	85	775	84	131	354	271	221	481	72
User Adj:	1.00	1.00	1.00	1.00	1.00	1.00	1.00	1.00	1.00	1.00	1.00	1.00
PHF Adj:	1.00	1.00	1.00	1.00	1.00	1.00	1.00	1.00	1.00	1.00	1.00	1.00
PHF Volume:	233	1185	221	85	775	84	131	354	271	221	481	72
Reduct Vol:	0	0	0	0	0	0	0	0	0	0	0	0
Reduced Vol:	233	1185	221	85	775	84	131	354	271	221	481	72
PCE Adj:	1.00	1.00	1.00	1.00	1.00	1.00	1.00	1.00	1.00	1.00	1.00	1.00
MLF Adj:	1.00	1.00	1.00	1.00	1.00	1.00	1.00	1.00	1.00	1.00	1.00	1.00
Final Volume:	233	1185	221	85	775	84	131	354	271	221	481	72

Saturation Flow Module:												
Sat/Lane:	1900	1900	1900	1900	1900	1900	1900	1900	1900	1900	1900	1900
Adjustment:	0.83	1.00	0.92	0.83	0.99	0.95	0.92	1.00	0.92	0.83	0.98	0.95
Lanes:	2.00	2.00	1.00	2.00	2.70	0.30	1.00	2.00	1.00	2.00	1.73	0.27
Final Sat.:	3150	3800	1750	3150	5052	548	1750	3800	1750	3150	3218	482

Capacity Analysis Module:												
Vol/Sat:	0.07	0.31	0.13	0.03	0.15	0.15	0.07	0.09	0.15	0.07	0.15	0.15
Crit Moves:	****			****			****			****		
Green Time:	21.4	58.7	58.7	7.0	44.4	44.4	14.1	27.5	27.5	14.8	28.2	28.2
Volume/Cap:	0.42	0.64	0.26	0.46	0.42	0.42	0.64	0.41	0.68	0.57	0.64	0.64
Delay/Veh:	44.3	23.5	18.1	56.5	28.3	28.3	57.0	39.6	46.8	51.6	42.9	42.9
User DelAdj:	1.00	1.00	1.00	1.00	1.00	1.00	1.00	1.00	1.00	1.00	1.00	1.00
AdjDel/Veh:	44.3	23.5	18.1	56.5	28.3	28.3	57.0	39.6	46.8	51.6	42.9	42.9
LOS by Move:	D	C	B-	E+	C	C	E+	D	D	D-	D	D
HCM2kAvgQ:	4	16	5	2	8	8	6	6	11	5	9	9

Note: Queue reported is the number of cars per lane.

Hamptons Apartment Complex TIA
SJ15-1612
Existing AM

Level Of Service Computation Report
2000 HCM Operations (Future Volume Alternative)
Existing AM

Intersection #6: Wolfe Road / Apple Campus 2

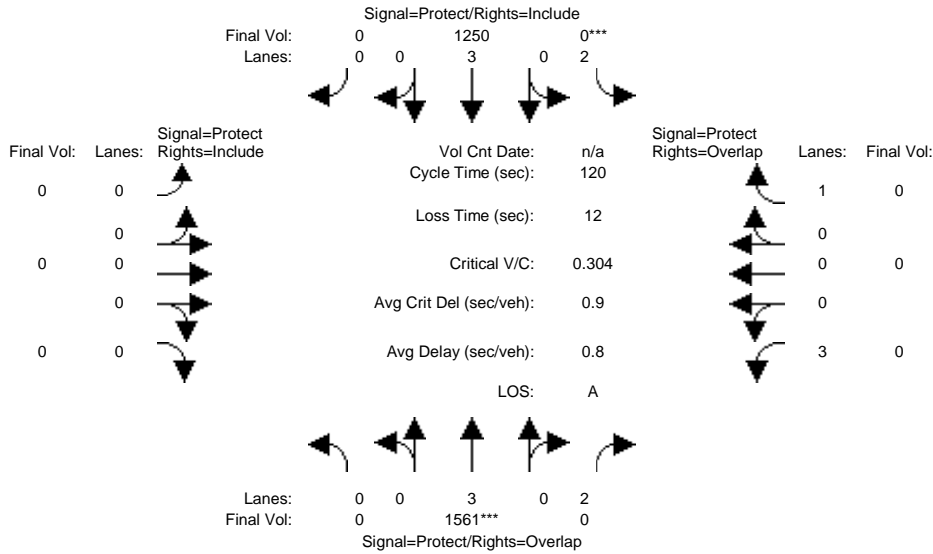

Street Name:	Wolfe Road						Apple Campus 2					
Approach:	North Bound			South Bound			East Bound			West Bound		
Movement:	L	T	R	L	T	R	L	T	R	L	T	R
Min. Green:	7	10	10	7	10	10	0	0	0	7	10	10
Y+R:	4.0	4.0	4.0	4.0	4.0	4.0	4.0	4.0	4.0	4.0	4.0	4.0
Volume Module:												
Base Vol:	0	1561	0	0	1250	0	0	0	0	0	0	0
Growth Adj:	1.00	1.00	1.00	1.00	1.00	1.00	1.00	1.00	1.00	1.00	1.00	1.00
Initial Bse:	0	1561	0	0	1250	0	0	0	0	0	0	0
Added Vol:	0	0	0	0	0	0	0	0	0	0	0	0
PasserByVol:	0	0	0	0	0	0	0	0	0	0	0	0
Initial Fut:	0	1561	0	0	1250	0	0	0	0	0	0	0
User Adj:	1.00	1.00	1.00	1.00	1.00	1.00	1.00	1.00	1.00	1.00	1.00	1.00
PHF Adj:	1.00	1.00	1.00	1.00	1.00	1.00	1.00	1.00	1.00	1.00	1.00	1.00
PHF Volume:	0	1561	0	0	1250	0	0	0	0	0	0	0
Reduct Vol:	0	0	0	0	0	0	0	0	0	0	0	0
Reduced Vol:	0	1561	0	0	1250	0	0	0	0	0	0	0
PCE Adj:	1.00	1.00	1.00	1.00	1.00	1.00	1.00	1.00	1.00	1.00	1.00	1.00
MLF Adj:	1.00	1.00	1.00	1.00	1.00	1.00	1.00	1.00	1.00	1.00	1.00	1.00
Final Volume:	0	1561	0	0	1250	0	0	0	0	0	0	0
Saturation Flow Module:												
Sat/Lane:	1900	1900	1900	1900	1900	1900	1900	1900	1900	1900	1900	1900
Adjustment:	0.92	1.00	0.83	0.83	1.00	0.92	0.92	1.00	0.92	0.80	1.00	0.92
Lanes:	0.00	3.00	2.00	2.00	3.00	0.00	0.00	0.00	0.00	3.00	0.00	1.00
Final Sat.:	0	5700	3150	3150	5700	0	0	0	0	4551	0	1750
Capacity Analysis Module:												
Vol/Sat:	0.00	0.27	0.00	0.00	0.22	0.00	0.00	0.00	0.00	0.00	0.00	0.00
Crit Moves:	****			****								
Green Time:	0.0	108	0.0	0.0	108	0.0	0.0	0.0	0.0	0.0	0.0	0.0
Volume/Cap:	0.00	0.30	0.00	0.00	0.24	0.00	0.00	0.00	0.00	0.00	0.00	0.00
Delay/Veh:	0.0	0.9	0.0	0.0	0.8	0.0	0.0	0.0	0.0	0.0	0.0	0.0
User DelAdj:	1.00	1.00	1.00	1.00	1.00	1.00	1.00	1.00	1.00	1.00	1.00	1.00
AdjDel/Veh:	0.0	0.9	0.0	0.0	0.8	0.0	0.0	0.0	0.0	0.0	0.0	0.0
LOS by Move:	A	A	A	A	A	A	A	A	A	A	A	A
HCM2kAvgQ:	0	3	0	0	2	0	0	0	0	0	0	0

Note: Queue reported is the number of cars per lane.

Hamptons Apartment Complex TIA
SJ15-1612
Existing AM

Level Of Service Computation Report
2000 HCM Operations (Future Volume Alternative)
Existing PP AM

Intersection #6: Wolfe Road / Apple Campus 2

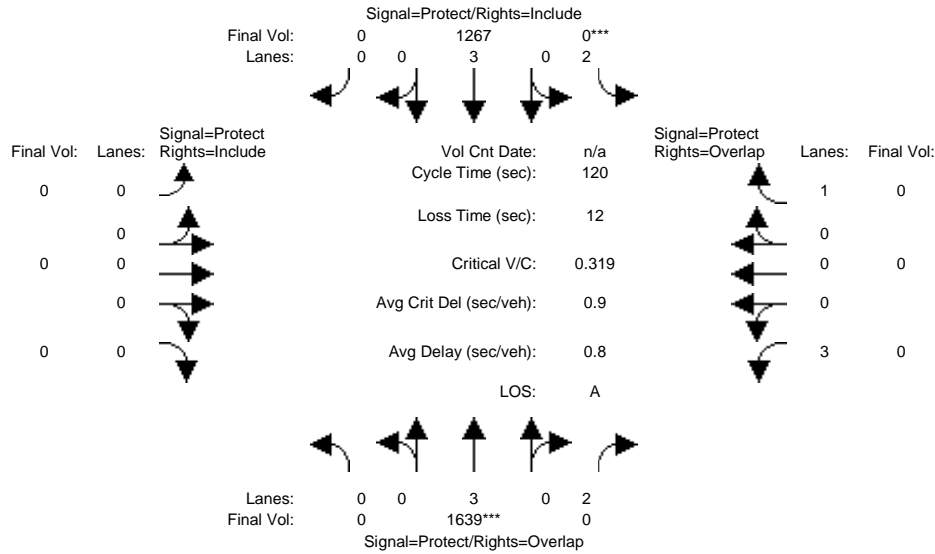

Street Name:	Wolfe Road						Apple Campus 2					
	North Bound			South Bound			East Bound			West Bound		
Approach:	North Bound			South Bound			East Bound			West Bound		
Movement:	L	T	R	L	T	R	L	T	R	L	T	R
Min. Green:	7	10	10	7	10	10	0	0	0	7	10	10
Y+R:	4.0	4.0	4.0	4.0	4.0	4.0	4.0	4.0	4.0	4.0	4.0	4.0

Volume Module:												
Base Vol:	0	1561	0	0	1250	0	0	0	0	0	0	0
Growth Adj:	1.00	1.00	1.00	1.00	1.00	1.00	1.00	1.00	1.00	1.00	1.00	1.00
Initial Bse:	0	1561	0	0	1250	0	0	0	0	0	0	0
Added Vol:	0	78	0	0	17	0	0	0	0	0	0	0
PasserByVol:	0	0	0	0	0	0	0	0	0	0	0	0
Initial Fut:	0	1639	0	0	1267	0	0	0	0	0	0	0
User Adj:	1.00	1.00	1.00	1.00	1.00	1.00	1.00	1.00	1.00	1.00	1.00	1.00
PHF Adj:	1.00	1.00	1.00	1.00	1.00	1.00	1.00	1.00	1.00	1.00	1.00	1.00
PHF Volume:	0	1639	0	0	1267	0	0	0	0	0	0	0
Reduct Vol:	0	0	0	0	0	0	0	0	0	0	0	0
Reduced Vol:	0	1639	0	0	1267	0	0	0	0	0	0	0
PCE Adj:	1.00	1.00	1.00	1.00	1.00	1.00	1.00	1.00	1.00	1.00	1.00	1.00
MLF Adj:	1.00	1.00	1.00	1.00	1.00	1.00	1.00	1.00	1.00	1.00	1.00	1.00
Final Volume:	0	1639	0	0	1267	0	0	0	0	0	0	0

Saturation Flow Module:												
Sat/Lane:	1900	1900	1900	1900	1900	1900	1900	1900	1900	1900	1900	1900
Adjustment:	0.92	1.00	0.83	0.83	1.00	0.92	0.92	1.00	0.92	0.80	1.00	0.92
Lanes:	0.00	3.00	2.00	2.00	3.00	0.00	0.00	0.00	0.00	3.00	0.00	1.00
Final Sat.:	0	5700	3150	3150	5700	0	0	0	0	4551	0	1750

Capacity Analysis Module:												
Vol/Sat:	0.00	0.29	0.00	0.00	0.22	0.00	0.00	0.00	0.00	0.00	0.00	0.00
Crit Moves:	****			****								
Green Time:	0.0	108	0.0	0.0	108	0.0	0.0	0.0	0.0	0.0	0.0	0.0
Volume/Cap:	0.00	0.32	0.00	0.00	0.25	0.00	0.00	0.00	0.00	0.00	0.00	0.00
Delay/Veh:	0.0	0.9	0.0	0.0	0.8	0.0	0.0	0.0	0.0	0.0	0.0	0.0
User DelAdj:	1.00	1.00	1.00	1.00	1.00	1.00	1.00	1.00	1.00	1.00	1.00	1.00
AdjDel/Veh:	0.0	0.9	0.0	0.0	0.8	0.0	0.0	0.0	0.0	0.0	0.0	0.0
LOS by Move:	A	A	A	A	A	A	A	A	A	A	A	A
HCM2kAvgQ:	0	3	0	0	2	0	0	0	0	0	0	0

Note: Queue reported is the number of cars per lane.

Hamptons Apartment Complex TIA
 SJ15-1612
 Existing AM

Level Of Service Computation Report
 2000 HCM Operations (Future Volume Alternative)
 Existing AM

Intersection #7: Wolfe Road / Pruneridge Avenue

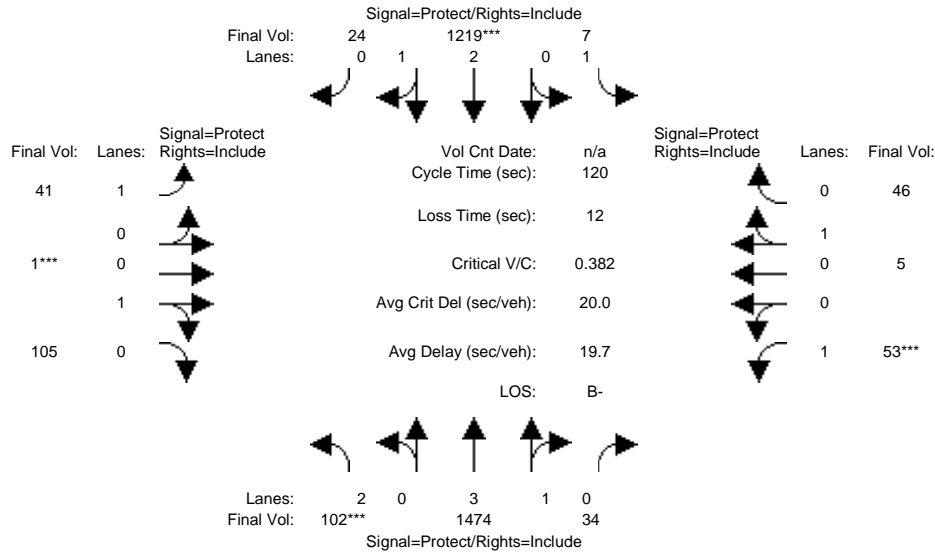

Street Name:	Wolfe Road						Pruneridge Avenue					
	North Bound			South Bound			East Bound			West Bound		
Approach:	L	T	R	L	T	R	L	T	R	L	T	R
Min. Green:	7	10	10	7	10	10	7	10	10	7	10	10
Y+R:	4.0	4.0	4.0	4.0	4.0	4.0	4.0	4.0	4.0	4.0	4.0	4.0

Volume Module:												
Base Vol:	102	1474	34	7	1219	24	41	1	105	53	5	46
Growth Adj:	1.00	1.00	1.00	1.00	1.00	1.00	1.00	1.00	1.00	1.00	1.00	1.00
Initial Bse:	102	1474	34	7	1219	24	41	1	105	53	5	46
Added Vol:	0	0	0	0	0	0	0	0	0	0	0	0
PasserByVol:	0	0	0	0	0	0	0	0	0	0	0	0
Initial Fut:	102	1474	34	7	1219	24	41	1	105	53	5	46
User Adj:	1.00	1.00	1.00	1.00	1.00	1.00	1.00	1.00	1.00	1.00	1.00	1.00
PHF Adj:	1.00	1.00	1.00	1.00	1.00	1.00	1.00	1.00	1.00	1.00	1.00	1.00
PHF Volume:	102	1474	34	7	1219	24	41	1	105	53	5	46
Reduct Vol:	0	0	0	0	0	0	0	0	0	0	0	0
Reduced Vol:	102	1474	34	7	1219	24	41	1	105	53	5	46
PCE Adj:	1.00	1.00	1.00	1.00	1.00	1.00	1.00	1.00	1.00	1.00	1.00	1.00
MLF Adj:	1.00	1.00	1.00	1.00	1.00	1.00	1.00	1.00	1.00	1.00	1.00	1.00
Final Volume:	102	1474	34	7	1219	24	41	1	105	53	5	46

Saturation Flow Module:												
Sat/Lane:	1900	1900	1900	1900	1900	1900	1900	1900	1900	1900	1900	1900
Adjustment:	0.83	0.99	0.95	0.92	0.98	0.95	0.92	0.95	0.95	0.92	0.95	0.95
Lanes:	2.00	3.91	0.09	1.00	2.94	0.06	1.00	0.01	0.99	1.00	0.10	0.90
Final Sat.:	3150	7331	169	1750	5492	108	1750	17	1783	1750	176	1624

Capacity Analysis Module:												
Vol/Sat:	0.03	0.20	0.20	0.00	0.22	0.22	0.02	0.06	0.06	0.03	0.03	0.03
Crit Moves:	***			****			****			****		
Green Time:	10.2	62.0	62.0	18.0	69.8	69.8	11.5	18.5	18.5	9.5	16.5	16.5
Volume/Cap:	0.38	0.39	0.39	0.03	0.38	0.38	0.24	0.38	0.38	0.38	0.21	0.21
Delay/Veh:	52.8	17.6	17.6	43.6	13.6	13.6	50.9	46.5	46.5	54.2	46.4	46.4
User DelAdj:	1.00	1.00	1.00	1.00	1.00	1.00	1.00	1.00	1.00	1.00	1.00	1.00
AdjDel/Veh:	52.8	17.6	17.6	43.6	13.6	13.6	50.9	46.5	46.5	54.2	46.4	46.4
LOS by Move:	D-	B	B	D	B	B	D	D	D	D-	D	D
HCM2kAvgQ:	2	8	8	0	8	8	2	4	4	2	2	2

Note: Queue reported is the number of cars per lane.

Hamptons Apartment Complex TIA
 SJ15-1612
 Existing AM

Level Of Service Computation Report
 2000 HCM Operations (Future Volume Alternative)
 Existing PP AM

Intersection #7: Wolfe Road / Pruneridge Avenue

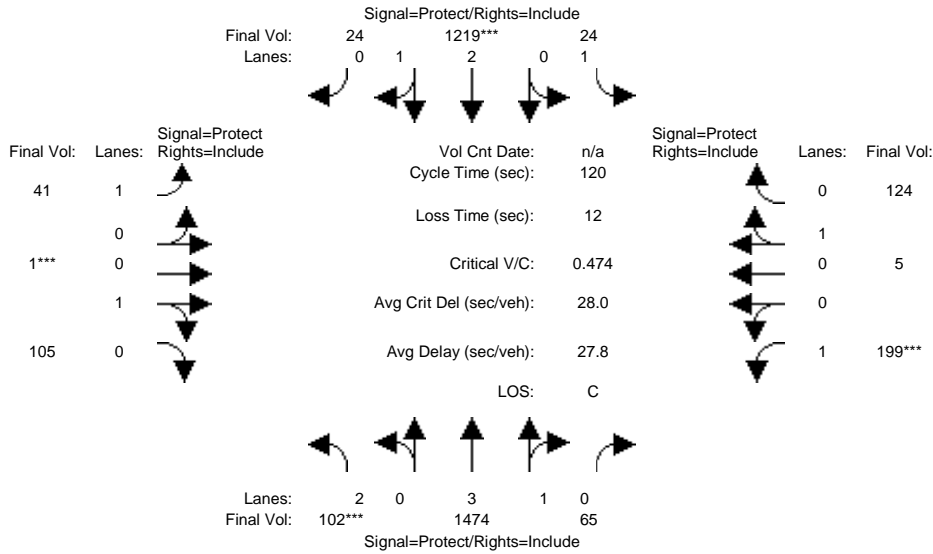

Street Name:	Wolfe Road						Pruneridge Avenue					
	North Bound			South Bound			East Bound			West Bound		
Approach:	L	T	R	L	T	R	L	T	R	L	T	R
Min. Green:	7	10	10	7	10	10	7	10	10	7	10	10
Y+R:	4.0	4.0	4.0	4.0	4.0	4.0	4.0	4.0	4.0	4.0	4.0	4.0

Volume Module:												
Base Vol:	102	1474	34	7	1219	24	41	1	105	53	5	46
Growth Adj:	1.00	1.00	1.00	1.00	1.00	1.00	1.00	1.00	1.00	1.00	1.00	1.00
Initial Bse:	102	1474	34	7	1219	24	41	1	105	53	5	46
Added Vol:	0	0	31	17	0	0	0	0	0	146	0	78
PasserByVol:	0	0	0	0	0	0	0	0	0	0	0	0
Initial Fut:	102	1474	65	24	1219	24	41	1	105	199	5	124
User Adj:	1.00	1.00	1.00	1.00	1.00	1.00	1.00	1.00	1.00	1.00	1.00	1.00
PHF Adj:	1.00	1.00	1.00	1.00	1.00	1.00	1.00	1.00	1.00	1.00	1.00	1.00
PHF Volume:	102	1474	65	24	1219	24	41	1	105	199	5	124
Reduct Vol:	0	0	0	0	0	0	0	0	0	0	0	0
Reduced Vol:	102	1474	65	24	1219	24	41	1	105	199	5	124
PCE Adj:	1.00	1.00	1.00	1.00	1.00	1.00	1.00	1.00	1.00	1.00	1.00	1.00
MLF Adj:	1.00	1.00	1.00	1.00	1.00	1.00	1.00	1.00	1.00	1.00	1.00	1.00
Final Volume:	102	1474	65	24	1219	24	41	1	105	199	5	124

Saturation Flow Module:												
Sat/Lane:	1900	1900	1900	1900	1900	1900	1900	1900	1900	1900	1900	1900
Adjustment:	0.83	0.99	0.95	0.92	0.98	0.95	0.92	0.95	0.95	0.92	0.95	0.95
Lanes:	2.00	3.82	0.18	1.00	2.94	0.06	1.00	0.01	0.99	1.00	0.04	0.96
Final Sat.:	3150	7183	317	1750	5492	108	1750	17	1783	1750	70	1730

Capacity Analysis Module:												
Vol/Sat:	0.03	0.21	0.21	0.01	0.22	0.22	0.02	0.06	0.06	0.11	0.07	0.07
Crit Moves:	***			****			****			****		
Green Time:	8.2	50.1	50.1	14.2	56.1	56.1	18.0	14.9	14.9	28.8	25.7	25.7
Volume/Cap:	0.47	0.49	0.49	0.12	0.47	0.47	0.16	0.47	0.47	0.47	0.33	0.33
Delay/Veh:	55.5	25.7	25.7	47.5	22.0	22.0	44.7	50.5	50.5	40.0	40.4	40.4
User DelAdj:	1.00	1.00	1.00	1.00	1.00	1.00	1.00	1.00	1.00	1.00	1.00	1.00
AdjDel/Veh:	55.5	25.7	25.7	47.5	22.0	22.0	44.7	50.5	50.5	40.0	40.4	40.4
LOS by Move:	E+	C	C	D	C+	C+	D	D	D	D	D	D
HCM2kAvgQ:	2	10	10	1	10	10	1	4	4	7	4	4

Note: Queue reported is the number of cars per lane.

Hamptons Apartment Complex TIA
 SJ15-1612
 Existing AM

Level Of Service Computation Report
 2000 HCM Operations (Future Volume Alternative)
 Existing AM

Intersection #8: Wolfe Road / I-280 NB Ramps

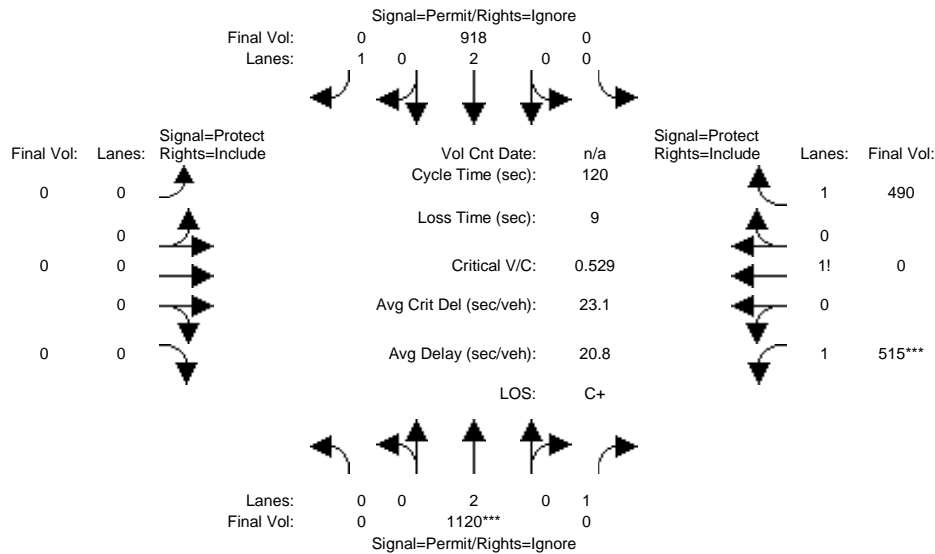

Street Name:	Wolfe Road						I-280 NB Ramps					
Approach:	North Bound			South Bound			East Bound			West Bound		
Movement:	L	T	R	L	T	R	L	T	R	L	T	R
Min. Green:	7	10	10	7	10	10	0	0	0	10	10	10
Y+R:	5.0	5.0	5.0	5.0	5.0	5.0	5.0	5.0	5.0	5.0	5.0	5.0
Volume Module:												
Base Vol:	0	1120	410	0	918	459	0	0	0	515	0	490
Growth Adj:	1.00	1.00	1.00	1.00	1.00	1.00	1.00	1.00	1.00	1.00	1.00	1.00
Initial Bse:	0	1120	410	0	918	459	0	0	0	515	0	490
Added Vol:	0	0	0	0	0	0	0	0	0	0	0	0
PasserByVol:	0	0	0	0	0	0	0	0	0	0	0	0
Initial Fut:	0	1120	410	0	918	459	0	0	0	515	0	490
User Adj:	1.00	1.00	0.00	1.00	1.00	0.00	1.00	1.00	1.00	1.00	1.00	1.00
PHF Adj:	1.00	1.00	0.00	1.00	1.00	0.00	1.00	1.00	1.00	1.00	1.00	1.00
PHF Volume:	0	1120	0	0	918	0	0	0	0	515	0	490
Reduct Vol:	0	0	0	0	0	0	0	0	0	0	0	0
Reduced Vol:	0	1120	0	0	918	0	0	0	0	515	0	490
PCE Adj:	1.00	1.00	0.00	1.00	1.00	0.00	1.00	1.00	1.00	1.00	1.00	1.00
MLF Adj:	1.00	1.00	0.00	1.00	1.00	0.00	1.00	1.00	1.00	1.00	1.00	1.00
Final Volume:	0	1120	0	0	918	0	0	0	0	515	0	490
Saturation Flow Module:												
Sat/Lane:	1900	1900	1900	1900	1900	1900	1900	1900	1900	1900	1900	1900
Adjustment:	0.92	1.00	0.92	0.92	1.00	0.92	0.92	1.00	0.92	0.92	1.00	0.92
Lanes:	0.00	2.00	1.00	0.00	2.00	1.00	0.00	0.00	0.00	1.51	0.00	1.49
Final Sat.:	0	3800	1750	0	3800	1750	0	0	0	2647	0	2603
Capacity Analysis Module:												
Vol/Sat:	0.00	0.29	0.00	0.00	0.24	0.00	0.00	0.00	0.00	0.19	0.00	0.19
Crit Moves:	****									****		
Green Time:	0.0	66.9	0.0	0.0	66.9	0.0	0.0	0.0	0.0	44.1	0.0	44.1
Volume/Cap:	0.00	0.53	0.00	0.00	0.43	0.00	0.00	0.00	0.00	0.53	0.00	0.51
Delay/Veh:	0.0	16.9	0.0	0.0	15.7	0.0	0.0	0.0	0.0	30.1	0.0	29.8
User DelAdj:	1.00	1.00	1.00	1.00	1.00	1.00	1.00	1.00	1.00	1.00	1.00	1.00
AdjDel/Veh:	0.0	16.9	0.0	0.0	15.7	0.0	0.0	0.0	0.0	30.1	0.0	29.8
LOS by Move:	A	B	A	A	B	A	A	A	A	C	A	C
HCM2kAvgQ:	0	3	0	0	2	0	0	0	0	11	0	10

Note: Queue reported is the number of cars per lane.

Hamptons Apartment Complex TIA
 SJ15-1612
 Existing AM

Level Of Service Computation Report
 2000 HCM Operations (Future Volume Alternative)
 Existing PP AM

Intersection #8: Wolfe Road / I-280 NB Ramps

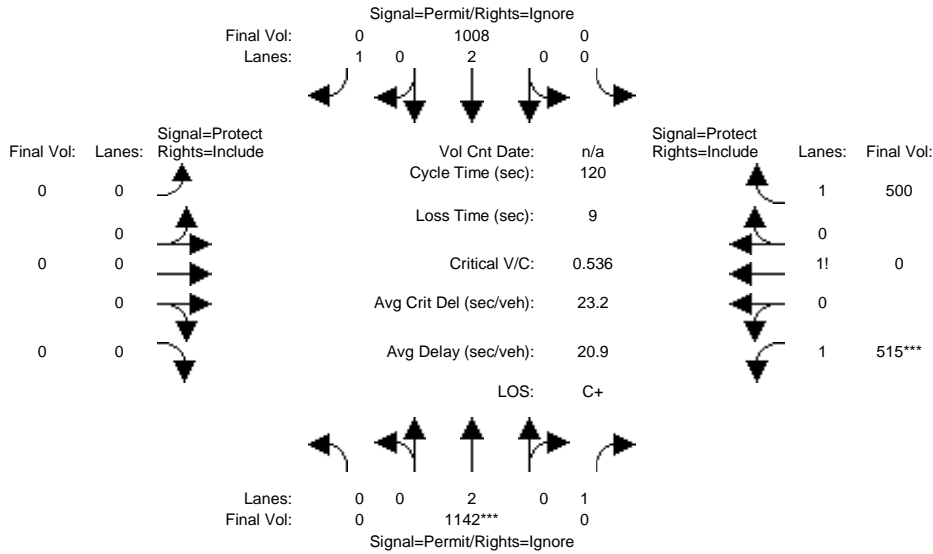

Street Name:	Wolfe Road						I-280 NB Ramps					
Approach:	North Bound			South Bound			East Bound			West Bound		
Movement:	L	T	R	L	T	R	L	T	R	L	T	R
Min. Green:	7	10	10	7	10	10	0	0	0	10	10	10
Y+R:	5.0	5.0	5.0	5.0	5.0	5.0	5.0	5.0	5.0	5.0	5.0	5.0
Volume Module:												
Base Vol:	0	1120	410	0	918	459	0	0	0	515	0	490
Growth Adj:	1.00	1.00	1.00	1.00	1.00	1.00	1.00	1.00	1.00	1.00	1.00	1.00
Initial Bse:	0	1120	410	0	918	459	0	0	0	515	0	490
Added Vol:	0	22	0	0	90	56	0	0	0	0	0	10
PasserByVol:	0	0	0	0	0	0	0	0	0	0	0	0
Initial Fut:	0	1142	410	0	1008	515	0	0	0	515	0	500
User Adj:	1.00	1.00	0.00	1.00	1.00	0.00	1.00	1.00	1.00	1.00	1.00	1.00
PHF Adj:	1.00	1.00	0.00	1.00	1.00	0.00	1.00	1.00	1.00	1.00	1.00	1.00
PHF Volume:	0	1142	0	0	1008	0	0	0	0	515	0	500
Reduct Vol:	0	0	0	0	0	0	0	0	0	0	0	0
Reduced Vol:	0	1142	0	0	1008	0	0	0	0	515	0	500
PCE Adj:	1.00	1.00	0.00	1.00	1.00	0.00	1.00	1.00	1.00	1.00	1.00	1.00
MLF Adj:	1.00	1.00	0.00	1.00	1.00	0.00	1.00	1.00	1.00	1.00	1.00	1.00
Final Volume:	0	1142	0	0	1008	0	0	0	0	515	0	500
Saturation Flow Module:												
Sat/Lane:	1900	1900	1900	1900	1900	1900	1900	1900	1900	1900	1900	1900
Adjustment:	0.92	1.00	0.92	0.92	1.00	0.92	0.92	1.00	0.92	0.92	1.00	0.92
Lanes:	0.00	2.00	1.00	0.00	2.00	1.00	0.00	0.00	0.00	1.51	0.00	1.49
Final Sat.:	0	3800	1750	0	3800	1750	0	0	0	2638	0	2612
Capacity Analysis Module:												
Vol/Sat:	0.00	0.30	0.00	0.00	0.27	0.00	0.00	0.00	0.00	0.20	0.00	0.19
Crit Moves:	****									****		
Green Time:	0.0	67.3	0.0	0.0	67.3	0.0	0.0	0.0	0.0	43.7	0.0	43.7
Volume/Cap:	0.00	0.54	0.00	0.00	0.47	0.00	0.00	0.00	0.00	0.54	0.00	0.53
Delay/Veh:	0.0	16.8	0.0	0.0	15.9	0.0	0.0	0.0	0.0	30.4	0.0	30.3
User DelAdj:	1.00	1.00	1.00	1.00	1.00	1.00	1.00	1.00	1.00	1.00	1.00	1.00
AdjDel/Veh:	0.0	16.8	0.0	0.0	15.9	0.0	0.0	0.0	0.0	30.4	0.0	30.3
LOS by Move:	A	B	A	A	B	A	A	A	A	C	A	C
HCM2kAvgQ:	0	3	0	0	3	0	0	0	0	11	0	11

Note: Queue reported is the number of cars per lane.

Hamptons Apartment Complex TIA
SJ15-1612
Existing AM

Level Of Service Computation Report
2000 HCM Operations (Future Volume Alternative)
Existing AM

Intersection #9: Wolfe Road / I-280 SB Ramps

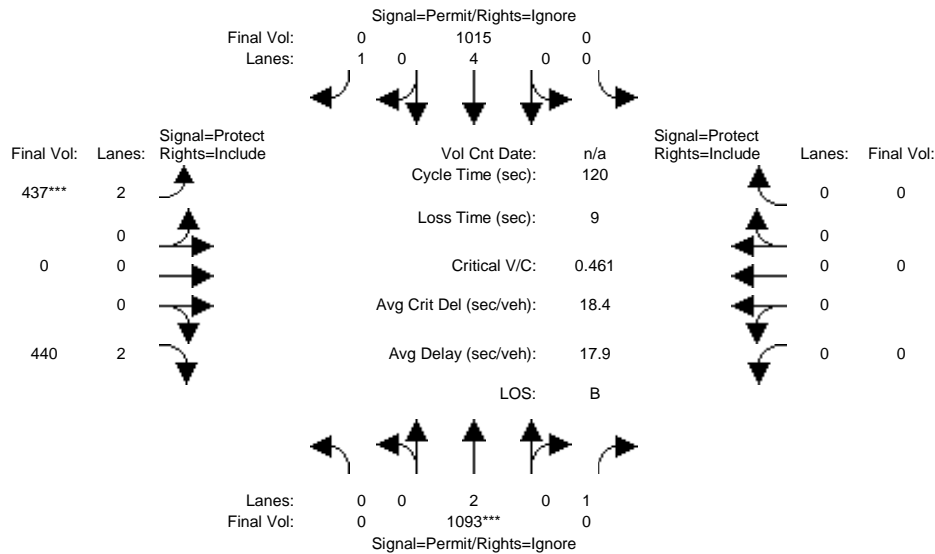

Street Name:	Wolfe Road						I-280 SB Ramps					
Approach:	North Bound			South Bound			East Bound			West Bound		
Movement:	L	T	R	L	T	R	L	T	R	L	T	R
Min. Green:	7	10	10	7	10	10	7	10	10	0	0	0
Y+R:	5.0	5.0	5.0	5.0	5.0	5.0	5.0	5.0	5.0	5.0	5.0	5.0
Volume Module:												
Base Vol:	0	1093	365	0	1015	418	437	0	440	0	0	0
Growth Adj:	1.00	1.00	1.00	1.00	1.00	1.00	1.00	1.00	1.00	1.00	1.00	1.00
Initial Bse:	0	1093	365	0	1015	418	437	0	440	0	0	0
Added Vol:	0	0	0	0	0	0	0	0	0	0	0	0
PasserByVol:	0	0	0	0	0	0	0	0	0	0	0	0
Initial Fut:	0	1093	365	0	1015	418	437	0	440	0	0	0
User Adj:	1.00	1.00	0.00	1.00	1.00	0.00	1.00	1.00	1.00	1.00	1.00	1.00
PHF Adj:	1.00	1.00	0.00	1.00	1.00	0.00	1.00	1.00	1.00	1.00	1.00	1.00
PHF Volume:	0	1093	0	0	1015	0	437	0	440	0	0	0
Reduct Vol:	0	0	0	0	0	0	0	0	0	0	0	0
Reduced Vol:	0	1093	0	0	1015	0	437	0	440	0	0	0
PCE Adj:	1.00	1.00	0.00	1.00	1.00	0.00	1.00	1.00	1.00	1.00	1.00	1.00
MLF Adj:	1.00	1.00	0.00	1.00	1.00	0.00	1.00	1.00	1.00	1.00	1.00	1.00
Final Volume:	0	1093	0	0	1015	0	437	0	440	0	0	0
Saturation Flow Module:												
Sat/Lane:	1900	1900	1900	1900	1900	1900	1900	1900	1900	1900	1900	1900
Adjustment:	0.92	1.00	0.92	0.92	1.00	0.92	0.83	1.00	0.83	0.92	1.00	0.92
Lanes:	0.00	2.00	1.00	0.00	4.00	1.00	2.00	0.00	2.00	0.00	0.00	0.00
Final Sat.:	0	3800	1750	0	7600	1750	3150	0	3150	0	0	0
Capacity Analysis Module:												
Vol/Sat:	0.00	0.29	0.00	0.00	0.13	0.00	0.14	0.00	0.14	0.00	0.00	0.00
Crit Moves:	****			****			****			****		
Green Time:	0.0	74.9	0.0	0.0	74.9	0.0	36.1	0.0	36.1	0.0	0.0	0.0
Volume/Cap:	0.00	0.46	0.00	0.00	0.21	0.00	0.46	0.00	0.46	0.00	0.00	0.00
Delay/Veh:	0.0	12.0	0.0	0.0	9.8	0.0	34.4	0.0	34.4	0.0	0.0	0.0
User DelAdj:	1.00	1.00	1.00	1.00	1.00	1.00	1.00	1.00	1.00	1.00	1.00	1.00
AdjDel/Veh:	0.0	12.0	0.0	0.0	9.8	0.0	34.4	0.0	34.4	0.0	0.0	0.0
LOS by Move:	A	B	A	A	A	A	C-	A	C-	A	A	A
HCM2kAvgQ:	0	1	0	0	0	0	8	0	8	0	0	0

Note: Queue reported is the number of cars per lane.

Hamptons Apartment Complex TIA
SJ15-1612
Existing AM

Level Of Service Computation Report
2000 HCM Operations (Future Volume Alternative)
Existing PP AM

Intersection #9: Wolfe Road / I-280 SB Ramps

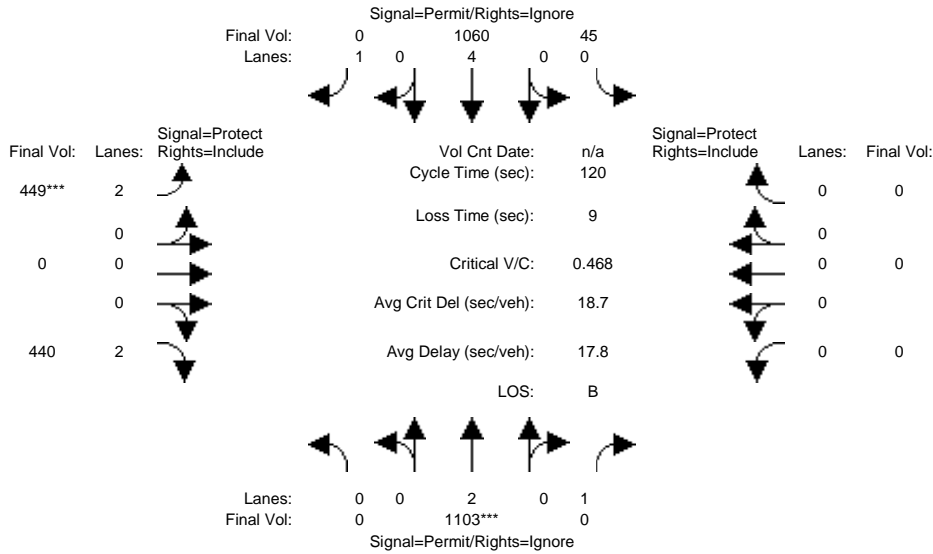

Street Name:	Wolfe Road						I-280 SB Ramps					
Approach:	North Bound			South Bound			East Bound			West Bound		
Movement:	L	T	R	L	T	R	L	T	R	L	T	R
Min. Green:	7	10	10	7	10	10	7	10	10	0	0	0
Y+R:	5.0	5.0	5.0	5.0	5.0	5.0	5.0	5.0	5.0	5.0	5.0	5.0
Volume Module:												
Base Vol:	0	1093	365	0	1015	418	437	0	440	0	0	0
Growth Adj:	1.00	1.00	1.00	1.00	1.00	1.00	1.00	1.00	1.00	1.00	1.00	1.00
Initial Bse:	0	1093	365	0	1015	418	437	0	440	0	0	0
Added Vol:	0	10	0	45	45	0	12	0	0	0	0	0
PasserByVol:	0	0	0	0	0	0	0	0	0	0	0	0
Initial Fut:	0	1103	365	45	1060	418	449	0	440	0	0	0
User Adj:	1.00	1.00	0.00	1.00	1.00	0.00	1.00	1.00	1.00	1.00	1.00	1.00
PHF Adj:	1.00	1.00	0.00	1.00	1.00	0.00	1.00	1.00	1.00	1.00	1.00	1.00
PHF Volume:	0	1103	0	45	1060	0	449	0	440	0	0	0
Reduct Vol:	0	0	0	0	0	0	0	0	0	0	0	0
Reduced Vol:	0	1103	0	45	1060	0	449	0	440	0	0	0
PCE Adj:	1.00	1.00	0.00	1.00	1.00	0.00	1.00	1.00	1.00	1.00	1.00	1.00
MLF Adj:	1.00	1.00	0.00	1.00	1.00	0.00	1.00	1.00	1.00	1.00	1.00	1.00
Final Volume:	0	1103	0	45	1060	0	449	0	440	0	0	0
Saturation Flow Module:												
Sat/Lane:	1900	1900	1900	1900	1900	1900	1900	1900	1900	1900	1900	1900
Adjustment:	0.92	1.00	0.92	0.95	0.99	0.92	0.83	1.00	0.83	0.92	1.00	0.92
Lanes:	0.00	2.00	1.00	0.17	3.83	1.00	2.00	0.00	2.00	0.00	0.00	0.00
Final Sat.:	0	3800	1750	305	7194	1750	3150	0	3150	0	0	0
Capacity Analysis Module:												
Vol/Sat:	0.00	0.29	0.00	0.15	0.15	0.00	0.14	0.00	0.14	0.00	0.00	0.00
Crit Moves:	****						****					
Green Time:	0.0	74.4	0.0	74.4	74.4	0.0	36.6	0.0	36.6	0.0	0.0	0.0
Volume/Cap:	0.00	0.47	0.00	0.24	0.24	0.00	0.47	0.00	0.46	0.00	0.00	0.00
Delay/Veh:	0.0	12.3	0.0	10.2	10.2	0.0	34.2	0.0	34.1	0.0	0.0	0.0
User DelAdj:	1.00	1.00	1.00	1.00	1.00	1.00	1.00	1.00	1.00	1.00	1.00	1.00
AdjDel/Veh:	0.0	12.3	0.0	10.2	10.2	0.0	34.2	0.0	34.1	0.0	0.0	0.0
LOS by Move:	A	B	A	B+	B+	A	C-	A	C-	A	A	A
HCM2kAvgQ:	0	1	0	0	0	0	8	0	8	0	0	0

Note: Queue reported is the number of cars per lane.

Hamptons Apartment Complex TIA
 SJ15-1612
 Existing AM

Level Of Service Computation Report
 2000 HCM Operations (Future Volume Alternative)
 Existing AM

Intersection #10: Wolfe Road / Vallco Parkway

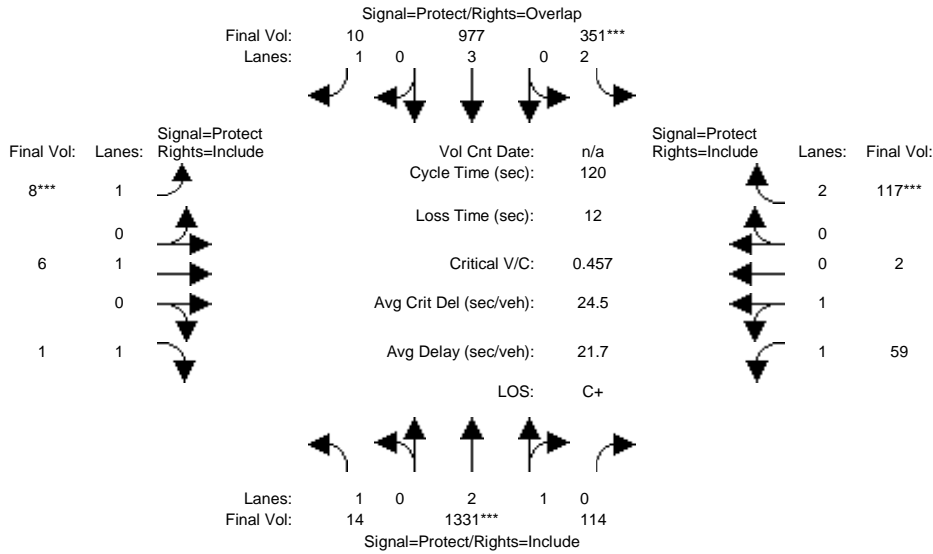

Street Name:	Wolfe Road						Vallco Parkway					
	North Bound			South Bound			East Bound			West Bound		
Approach:	North Bound			South Bound			East Bound			West Bound		
Movement:	L	T	R	L	T	R	L	T	R	L	T	R
Min. Green:	7	10	10	7	10	10	7	10	10	7	10	10
Y+R:	4.0	4.0	4.0	4.0	4.0	4.0	4.0	4.0	4.0	4.0	4.0	4.0

Volume Module:												
Base Vol:	14	1331	114	351	977	10	8	6	1	59	2	117
Growth Adj:	1.00	1.00	1.00	1.00	1.00	1.00	1.00	1.00	1.00	1.00	1.00	1.00
Initial Bse:	14	1331	114	351	977	10	8	6	1	59	2	117
Added Vol:	0	0	0	0	0	0	0	0	0	0	0	0
PasserByVol:	0	0	0	0	0	0	0	0	0	0	0	0
Initial Fut:	14	1331	114	351	977	10	8	6	1	59	2	117
User Adj:	1.00	1.00	1.00	1.00	1.00	1.00	1.00	1.00	1.00	1.00	1.00	1.00
PHF Adj:	1.00	1.00	1.00	1.00	1.00	1.00	1.00	1.00	1.00	1.00	1.00	1.00
PHF Volume:	14	1331	114	351	977	10	8	6	1	59	2	117
Reduct Vol:	0	0	0	0	0	0	0	0	0	0	0	0
Reduced Vol:	14	1331	114	351	977	10	8	6	1	59	2	117
PCE Adj:	1.00	1.00	1.00	1.00	1.00	1.00	1.00	1.00	1.00	1.00	1.00	1.00
MLF Adj:	1.00	1.00	1.00	1.00	1.00	1.00	1.00	1.00	1.00	1.00	1.00	1.00
Final Volume:	14	1331	114	351	977	10	8	6	1	59	2	117

Saturation Flow Module:												
Sat/Lane:	1900	1900	1900	1900	1900	1900	1900	1900	1900	1900	1900	1900
Adjustment:	0.92	0.99	0.95	0.83	1.00	0.92	0.92	1.00	0.92	0.93	0.95	0.83
Lanes:	1.00	2.75	0.25	2.00	3.00	1.00	1.00	1.00	1.00	1.94	0.06	2.00
Final Sat.:	1750	5158	442	3150	5700	1750	1750	1900	1750	3434	116	3150

Capacity Analysis Module:												
Vol/Sat:	0.01	0.26	0.26	0.11	0.17	0.01	0.00	0.00	0.00	0.02	0.02	0.04
Crit Moves:	****			****			****			****		
Green Time:	23.1	63.6	63.6	27.4	67.9	74.9	7.0	10.0	10.0	7.0	10.0	10.0
Volume/Cap:	0.04	0.49	0.49	0.49	0.30	0.01	0.08	0.04	0.01	0.29	0.21	0.45
Delay/Veh:	39.5	18.0	18.0	40.7	13.7	8.5	53.8	50.7	50.5	54.9	51.6	53.6
User DelAdj:	1.00	1.00	1.00	1.00	1.00	1.00	1.00	1.00	1.00	1.00	1.00	1.00
AdjDel/Veh:	39.5	18.0	18.0	40.7	13.7	8.5	53.8	50.7	50.5	54.9	51.6	53.6
LOS by Move:	D	B-	B-	D	B	A	D-	D	D	D-	D-	D-
HCM2kAvgQ:	0	11	11	7	6	0	0	0	0	1	1	2

Note: Queue reported is the number of cars per lane.

Hamptons Apartment Complex TIA
 SJ15-1612
 Existing AM

Level Of Service Computation Report
 2000 HCM Operations (Future Volume Alternative)
 Existing PP AM

Intersection #10: Wolfe Road / Vallco Parkway

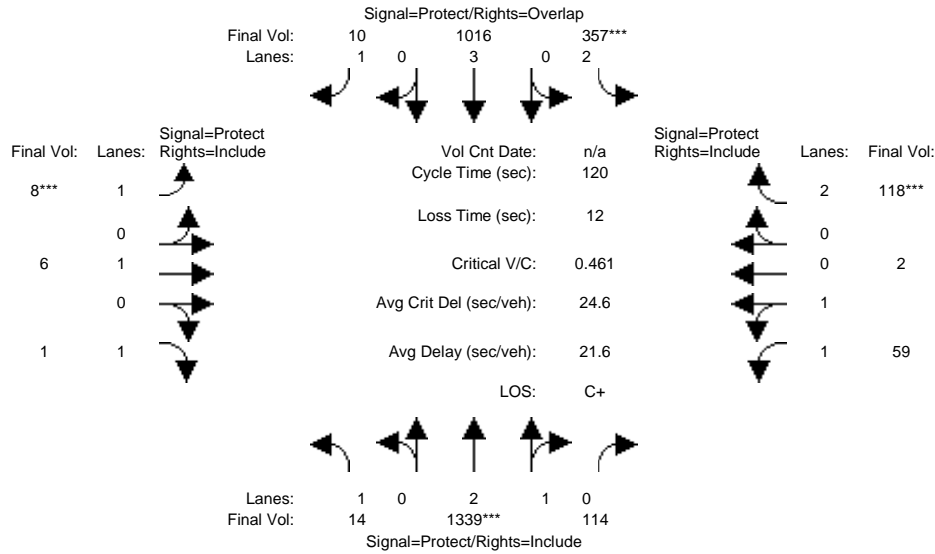

Street Name:	Wolfe Road						Vallco Parkway					
	North Bound			South Bound			East Bound			West Bound		
Approach:	North Bound			South Bound			East Bound			West Bound		
Movement:	L	T	R	L	T	R	L	T	R	L	T	R
Min. Green:	7	10	10	7	10	10	7	10	10	7	10	10
Y+R:	4.0	4.0	4.0	4.0	4.0	4.0	4.0	4.0	4.0	4.0	4.0	4.0

Volume Module:												
Base Vol:	14	1331	114	351	977	10	8	6	1	59	2	117
Growth Adj:	1.00	1.00	1.00	1.00	1.00	1.00	1.00	1.00	1.00	1.00	1.00	1.00
Initial Bse:	14	1331	114	351	977	10	8	6	1	59	2	117
Added Vol:	0	8	0	6	39	0	0	0	0	0	0	1
PasserByVol:	0	0	0	0	0	0	0	0	0	0	0	0
Initial Fut:	14	1339	114	357	1016	10	8	6	1	59	2	118
User Adj:	1.00	1.00	1.00	1.00	1.00	1.00	1.00	1.00	1.00	1.00	1.00	1.00
PHF Adj:	1.00	1.00	1.00	1.00	1.00	1.00	1.00	1.00	1.00	1.00	1.00	1.00
PHF Volume:	14	1339	114	357	1016	10	8	6	1	59	2	118
Reduct Vol:	0	0	0	0	0	0	0	0	0	0	0	0
Reduced Vol:	14	1339	114	357	1016	10	8	6	1	59	2	118
PCE Adj:	1.00	1.00	1.00	1.00	1.00	1.00	1.00	1.00	1.00	1.00	1.00	1.00
MLF Adj:	1.00	1.00	1.00	1.00	1.00	1.00	1.00	1.00	1.00	1.00	1.00	1.00
Final Volume:	14	1339	114	357	1016	10	8	6	1	59	2	118

Saturation Flow Module:												
Sat/Lane:	1900	1900	1900	1900	1900	1900	1900	1900	1900	1900	1900	1900
Adjustment:	0.92	0.99	0.95	0.83	1.00	0.92	0.92	1.00	0.92	0.93	0.95	0.83
Lanes:	1.00	2.76	0.24	2.00	3.00	1.00	1.00	1.00	1.00	1.94	0.06	2.00
Final Sat.:	1750	5160	439	3150	5700	1750	1750	1900	1750	3434	116	3150

Capacity Analysis Module:												
Vol/Sat:	0.01	0.26	0.26	0.11	0.18	0.01	0.00	0.00	0.00	0.02	0.02	0.04
Crit Moves:	****			****			****			****		
Green Time:	22.4	63.3	63.3	27.7	68.6	75.6	7.0	10.0	10.0	7.0	10.0	10.0
Volume/Cap:	0.04	0.49	0.49	0.49	0.31	0.01	0.08	0.04	0.01	0.29	0.21	0.45
Delay/Veh:	40.0	18.2	18.2	40.6	13.5	8.3	53.8	50.7	50.5	54.9	51.6	53.6
User DelAdj:	1.00	1.00	1.00	1.00	1.00	1.00	1.00	1.00	1.00	1.00	1.00	1.00
AdjDel/Veh:	40.0	18.2	18.2	40.6	13.5	8.3	53.8	50.7	50.5	54.9	51.6	53.6
LOS by Move:	D	B-	B-	D	B	A	D-	D	D	D-	D-	D-
HCM2kAvgQ:	0	11	11	7	6	0	0	0	0	1	1	2

Note: Queue reported is the number of cars per lane.

Hamptons Apartment Complex TIA
 SJ15-1612
 Existing AM

Level Of Service Computation Report
 2000 HCM Operations (Future Volume Alternative)
 Existing AM

Intersection #11: Wolfe Road / Stevens Creek Boulevard

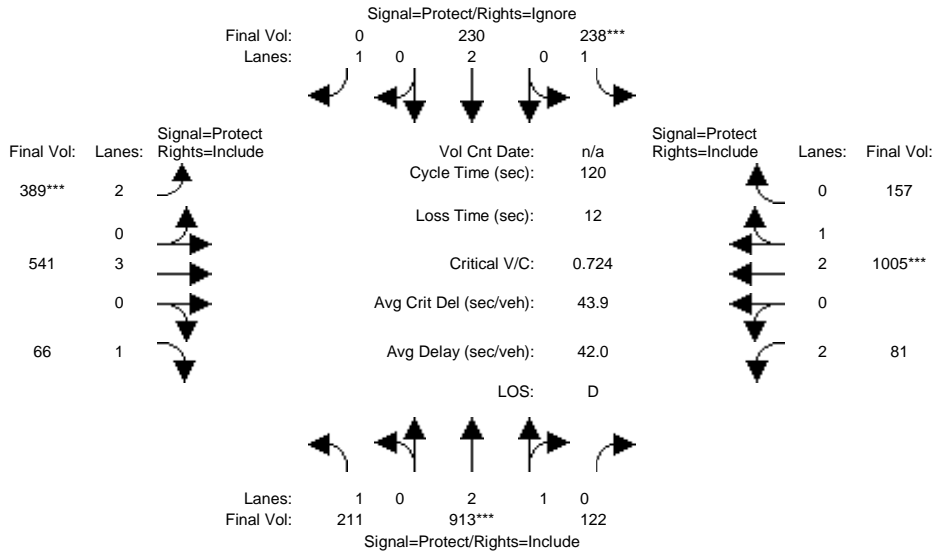

Street Name:	Wolfe Road						Stevens Creek Boulevard					
	North Bound			South Bound			East Bound			West Bound		
Approach:	L	T	R	L	T	R	L	T	R	L	T	R
Min. Green:	7	10	10	7	10	10	7	10	10	7	10	10
Y+R:	5.0	5.0	5.0	5.0	5.0	5.0	5.0	5.0	5.0	5.0	5.0	5.0

Volume Module:												
Base Vol:	211	913	122	238	230	536	389	541	66	81	1005	157
Growth Adj:	1.00	1.00	1.00	1.00	1.00	1.00	1.00	1.00	1.00	1.00	1.00	1.00
Initial Bse:	211	913	122	238	230	536	389	541	66	81	1005	157
Added Vol:	0	0	0	0	0	0	0	0	0	0	0	0
PasserByVol:	0	0	0	0	0	0	0	0	0	0	0	0
Initial Fut:	211	913	122	238	230	536	389	541	66	81	1005	157
User Adj:	1.00	1.00	1.00	1.00	1.00	0.00	1.00	1.00	1.00	1.00	1.00	1.00
PHF Adj:	1.00	1.00	1.00	1.00	1.00	0.00	1.00	1.00	1.00	1.00	1.00	1.00
PHF Volume:	211	913	122	238	230	0	389	541	66	81	1005	157
Reduct Vol:	0	0	0	0	0	0	0	0	0	0	0	0
Reduced Vol:	211	913	122	238	230	0	389	541	66	81	1005	157
PCE Adj:	1.00	1.00	1.00	1.00	1.00	0.00	1.00	1.00	1.00	1.00	1.00	1.00
MLF Adj:	1.00	1.00	1.00	1.00	1.00	0.00	1.00	1.00	1.00	1.00	1.00	1.00
Final Volume:	211	913	122	238	230	0	389	541	66	81	1005	157

Saturation Flow Module:												
Sat/Lane:	1900	1900	1900	1900	1900	1900	1900	1900	1900	1900	1900	1900
Adjustment:	0.92	0.99	0.95	0.92	1.00	0.92	0.83	1.00	0.92	0.83	0.99	0.95
Lanes:	1.00	2.63	0.37	1.00	2.00	1.00	2.00	3.00	1.00	2.00	2.58	0.42
Final Sat.:	1750	4939	660	1750	3800	1750	3150	5700	1750	3150	4842	756

Capacity Analysis Module:												
Vol/Sat:	0.12	0.18	0.18	0.14	0.06	0.00	0.12	0.09	0.04	0.03	0.21	0.21
Crit Moves:	****			****			****			****		
Green Time:	31.4	30.6	30.6	22.5	21.7	0.0	20.5	34.0	34.0	20.9	34.4	34.4
Volume/Cap:	0.46	0.72	0.72	0.72	0.33	0.00	0.72	0.34	0.13	0.15	0.72	0.72
Delay/Veh:	37.9	42.7	42.7	53.6	43.1	0.0	52.0	34.2	32.2	42.1	40.2	40.2
User DelAdj:	1.00	1.00	1.00	1.00	1.00	1.00	1.00	1.00	1.00	1.00	1.00	1.00
AdjDel/Veh:	37.9	42.7	42.7	53.6	43.1	0.0	52.0	34.2	32.2	42.1	40.2	40.2
LOS by Move:	D+	D	D	D-	D	A	D-	C-	C-	D	D	D
HCM2kAvgQ:	7	13	13	9	3	0	8	4	1	1	12	12

Note: Queue reported is the number of cars per lane.

Hamptons Apartment Complex TIA
 SJ15-1612
 Existing AM

Level Of Service Computation Report
 2000 HCM Operations (Future Volume Alternative)
 Existing PP AM

Intersection #11: Wolfe Road / Stevens Creek Boulevard

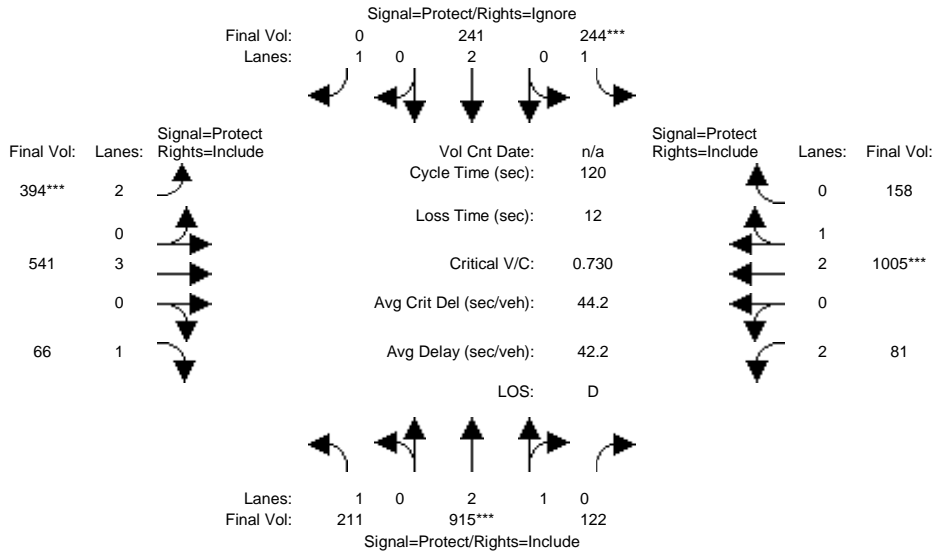

Street Name:	Wolfe Road						Stevens Creek Boulevard					
	North Bound			South Bound			East Bound			West Bound		
Approach:												
Movement:	L	T	R	L	T	R	L	T	R	L	T	R
Min. Green:	7	10	10	7	10	10	7	10	10	7	10	10
Y+R:	5.0	5.0	5.0	5.0	5.0	5.0	5.0	5.0	5.0	5.0	5.0	5.0

Volume Module:												
Base Vol:	211	913	122	238	230	536	389	541	66	81	1005	157
Growth Adj:	1.00	1.00	1.00	1.00	1.00	1.00	1.00	1.00	1.00	1.00	1.00	1.00
Initial Bse:	211	913	122	238	230	536	389	541	66	81	1005	157
Added Vol:	0	2	0	6	11	22	5	0	0	0	0	1
PasserByVol:	0	0	0	0	0	0	0	0	0	0	0	0
Initial Fut:	211	915	122	244	241	558	394	541	66	81	1005	158
User Adj:	1.00	1.00	1.00	1.00	1.00	0.00	1.00	1.00	1.00	1.00	1.00	1.00
PHF Adj:	1.00	1.00	1.00	1.00	1.00	0.00	1.00	1.00	1.00	1.00	1.00	1.00
PHF Volume:	211	915	122	244	241	0	394	541	66	81	1005	158
Reduct Vol:	0	0	0	0	0	0	0	0	0	0	0	0
Reduced Vol:	211	915	122	244	241	0	394	541	66	81	1005	158
PCE Adj:	1.00	1.00	1.00	1.00	1.00	0.00	1.00	1.00	1.00	1.00	1.00	1.00
MLF Adj:	1.00	1.00	1.00	1.00	1.00	0.00	1.00	1.00	1.00	1.00	1.00	1.00
Final Volume:	211	915	122	244	241	0	394	541	66	81	1005	158

Saturation Flow Module:												
Sat/Lane:	1900	1900	1900	1900	1900	1900	1900	1900	1900	1900	1900	1900
Adjustment:	0.92	0.99	0.95	0.92	1.00	0.92	0.83	1.00	0.92	0.83	0.99	0.95
Lanes:	1.00	2.63	0.37	1.00	2.00	1.00	2.00	3.00	1.00	2.00	2.58	0.42
Final Sat.:	1750	4940	659	1750	3800	1750	3150	5700	1750	3150	4838	761

Capacity Analysis Module:												
Vol/Sat:	0.12	0.19	0.19	0.14	0.06	0.00	0.13	0.09	0.04	0.03	0.21	0.21
Crit Moves:	****			****			****			****		
Green Time:	31.5	30.4	30.4	22.9	21.8	0.0	20.5	33.9	33.9	20.8	34.1	34.1
Volume/Cap:	0.46	0.73	0.73	0.73	0.35	0.00	0.73	0.34	0.13	0.15	0.73	0.73
Delay/Veh:	37.8	43.0	43.0	53.6	43.2	0.0	52.2	34.3	32.3	42.2	40.5	40.5
User DelAdj:	1.00	1.00	1.00	1.00	1.00	1.00	1.00	1.00	1.00	1.00	1.00	1.00
AdjDel/Veh:	37.8	43.0	43.0	53.6	43.2	0.0	52.2	34.3	32.3	42.2	40.5	40.5
LOS by Move:	D+	D	D	D-	D	A	D-	C-	C-	D	D	D
HCM2kAvgQ:	7	13	13	9	4	0	8	4	1	1	12	12

Note: Queue reported is the number of cars per lane.

Hamptons Apartment Complex TIA
 SJ15-1612
 Existing AM

Level Of Service Computation Report
 2000 HCM Operations (Future Volume Alternative)
 Existing AM

Intersection #12: De Anza Boulevard / Stevens Creek Boulevard

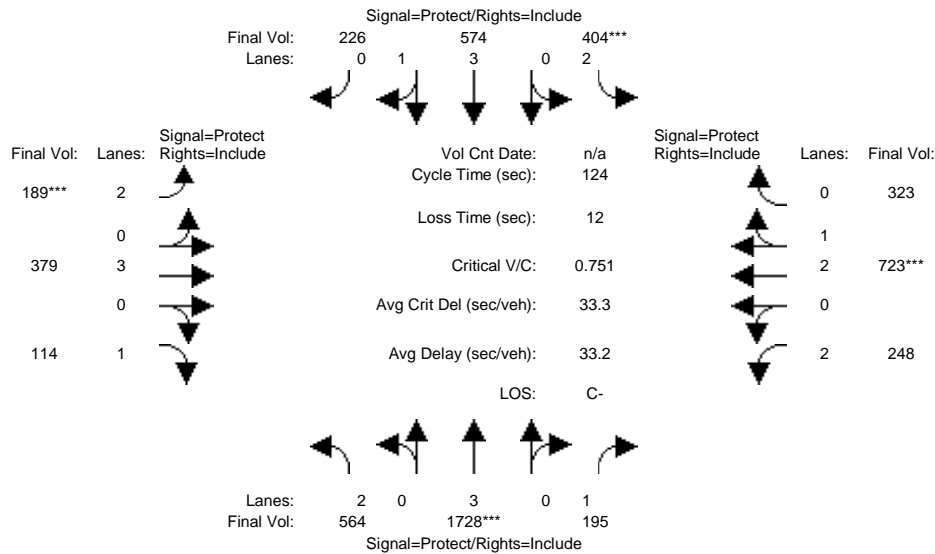

Street Name:	De Anza Boulevard						Stevens Creek Boulevard					
	North Bound			South Bound			East Bound			West Bound		
Approach:	North Bound			South Bound			East Bound			West Bound		
Movement:	L	T	R	L	T	R	L	T	R	L	T	R
Min. Green:	7	10	10	7	10	10	7	10	10	7	10	10
Y+R:	5.0	5.0	5.0	5.0	5.0	5.0	5.0	5.0	5.0	5.0	5.0	5.0

Volume Module:												
Base Vol:	564	1728	195	404	574	226	189	379	114	248	723	323
Growth Adj:	1.00	1.00	1.00	1.00	1.00	1.00	1.00	1.00	1.00	1.00	1.00	1.00
Initial Bse:	564	1728	195	404	574	226	189	379	114	248	723	323
Added Vol:	0	0	0	0	0	0	0	0	0	0	0	0
PasserByVol:	0	0	0	0	0	0	0	0	0	0	0	0
Initial Fut:	564	1728	195	404	574	226	189	379	114	248	723	323
User Adj:	1.00	1.00	1.00	1.00	1.00	1.00	1.00	1.00	1.00	1.00	1.00	1.00
PHF Adj:	1.00	1.00	1.00	1.00	1.00	1.00	1.00	1.00	1.00	1.00	1.00	1.00
PHF Volume:	564	1728	195	404	574	226	189	379	114	248	723	323
Reduct Vol:	0	0	0	0	0	0	0	0	0	0	0	0
Reduced Vol:	564	1728	195	404	574	226	189	379	114	248	723	323
PCE Adj:	1.00	1.00	1.00	1.00	1.00	1.00	1.00	1.00	1.00	1.00	1.00	1.00
MLF Adj:	1.00	1.00	1.00	1.00	1.00	1.00	1.00	1.00	1.00	1.00	1.00	1.00
Final Volume:	564	1728	195	404	574	226	189	379	114	248	723	323

Saturation Flow Module:												
Sat/Lane:	1900	1900	1900	1900	1900	1900	1900	1900	1900	1900	1900	1900
Adjustment:	0.83	1.00	0.92	0.83	1.00	0.92	0.83	1.00	0.92	0.83	1.00	0.95
Lanes:	2.00	3.00	1.00	2.00	3.00	1.00	2.00	3.00	1.00	2.00	2.04	0.96
Final Sat.:	3150	5700	1750	3150	5700	1750	3150	5700	1750	3150	3868	1728

Capacity Analysis Module:												
Vol/Sat:	0.18	0.30	0.11	0.13	0.10	0.13	0.06	0.07	0.07	0.08	0.19	0.19
Crit Moves:	****			****			****			****		
Green Time:	41.4	50.1	50.1	21.2	29.8	29.8	9.9	20.6	20.6	20.1	30.9	30.9
Volume/Cap:	0.54	0.75	0.28	0.75	0.42	0.54	0.75	0.40	0.39	0.48	0.75	0.75
Delay/Veh:	22.9	18.8	13.8	48.1	31.5	32.8	67.8	46.4	47.0	47.9	45.4	45.4
User DelAdj:	1.00	1.00	1.00	1.00	1.00	1.00	1.00	1.00	1.00	1.00	1.00	1.00
AdjDel/Veh:	22.9	18.8	13.8	48.1	31.5	32.8	67.8	46.4	47.0	47.9	45.4	45.4
LOS by Move:	C+	B-	B	D	C	C-	E	D	D	D	D	D
HCM2kAvgQ:	9	16	3	10	5	8	6	4	4	5	12	12

Note: Queue reported is the number of cars per lane.

Hamptons Apartment Complex TIA
 SJ15-1612
 Existing AM

Level Of Service Computation Report
 2000 HCM Operations (Future Volume Alternative)
 Existing PP AM

Intersection #12: De Anza Boulevard / Stevens Creek Boulevard

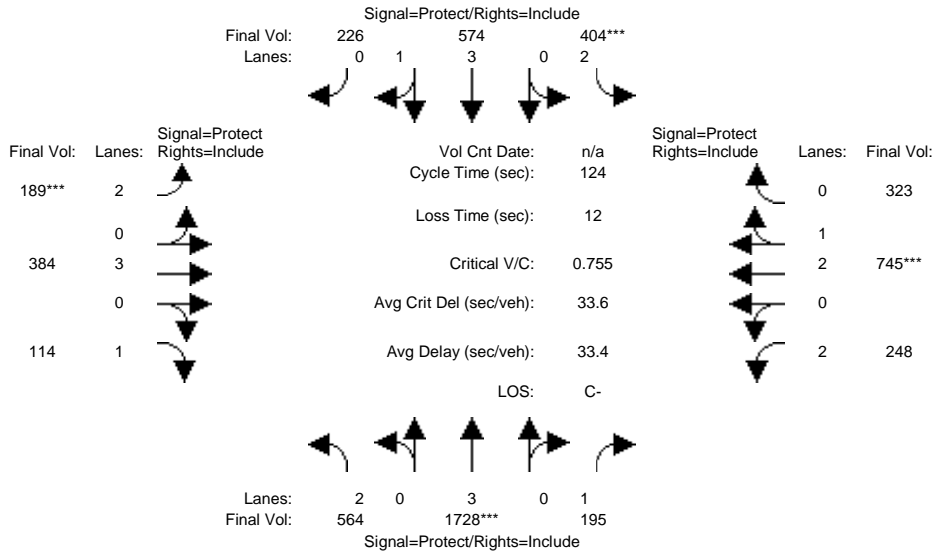

Street Name:	De Anza Boulevard						Stevens Creek Boulevard					
	North Bound			South Bound			East Bound			West Bound		
Approach:												
Movement:	L	T	R	L	T	R	L	T	R	L	T	R
Min. Green:	7	10	10	7	10	10	7	10	10	7	10	10
Y+R:	5.0	5.0	5.0	5.0	5.0	5.0	5.0	5.0	5.0	5.0	5.0	5.0

Volume Module:												
Base Vol:	564	1728	195	404	574	226	189	379	114	248	723	323
Growth Adj:	1.00	1.00	1.00	1.00	1.00	1.00	1.00	1.00	1.00	1.00	1.00	1.00
Initial Bse:	564	1728	195	404	574	226	189	379	114	248	723	323
Added Vol:	0	0	0	0	0	0	0	5	0	0	22	0
PasserByVol:	0	0	0	0	0	0	0	0	0	0	0	0
Initial Fut:	564	1728	195	404	574	226	189	384	114	248	745	323
User Adj:	1.00	1.00	1.00	1.00	1.00	1.00	1.00	1.00	1.00	1.00	1.00	1.00
PHF Adj:	1.00	1.00	1.00	1.00	1.00	1.00	1.00	1.00	1.00	1.00	1.00	1.00
PHF Volume:	564	1728	195	404	574	226	189	384	114	248	745	323
Reduct Vol:	0	0	0	0	0	0	0	0	0	0	0	0
Reduced Vol:	564	1728	195	404	574	226	189	384	114	248	745	323
PCE Adj:	1.00	1.00	1.00	1.00	1.00	1.00	1.00	1.00	1.00	1.00	1.00	1.00
MLF Adj:	1.00	1.00	1.00	1.00	1.00	1.00	1.00	1.00	1.00	1.00	1.00	1.00
Final Volume:	564	1728	195	404	574	226	189	384	114	248	745	323

Saturation Flow Module:												
Sat/Lane:	1900	1900	1900	1900	1900	1900	1900	1900	1900	1900	1900	1900
Adjustment:	0.83	1.00	0.92	0.83	1.00	0.92	0.83	1.00	0.92	0.83	1.00	0.95
Lanes:	2.00	3.00	1.00	2.00	3.00	1.00	2.00	3.00	1.00	2.00	2.06	0.94
Final Sat.:	3150	5700	1750	3150	5700	1750	3150	5700	1750	3150	3904	1693

Capacity Analysis Module:												
Vol/Sat:	0.18	0.30	0.11	0.13	0.10	0.13	0.06	0.07	0.07	0.08	0.19	0.19
Crit Moves:	****			****			****			****		
Green Time:	41.1	49.8	49.8	21.1	29.7	29.7	9.8	20.8	20.8	20.3	31.3	31.3
Volume/Cap:	0.54	0.76	0.28	0.76	0.42	0.54	0.76	0.40	0.39	0.48	0.76	0.76
Delay/Veh:	23.1	19.1	14.0	48.4	31.7	33.0	68.2	46.3	46.8	47.7	45.2	45.2
User DelAdj:	1.00	1.00	1.00	1.00	1.00	1.00	1.00	1.00	1.00	1.00	1.00	1.00
AdjDel/Veh:	23.1	19.1	14.0	48.4	31.7	33.0	68.2	46.3	46.8	47.7	45.2	45.2
LOS by Move:	C	B-	B	D	C	C-	E	D	D	D	D	D
HCM2kAvgQ:	9	16	3	10	5	8	6	4	4	5	12	12

Note: Queue reported is the number of cars per lane.

Hamptons Apartment Complex TIA
 SJ15-1612
 Existing AM

Level Of Service Computation Report
 2000 HCM Operations (Future Volume Alternative)
 Existing AM

Intersection #13: Tantau Avenue / Homestead Road

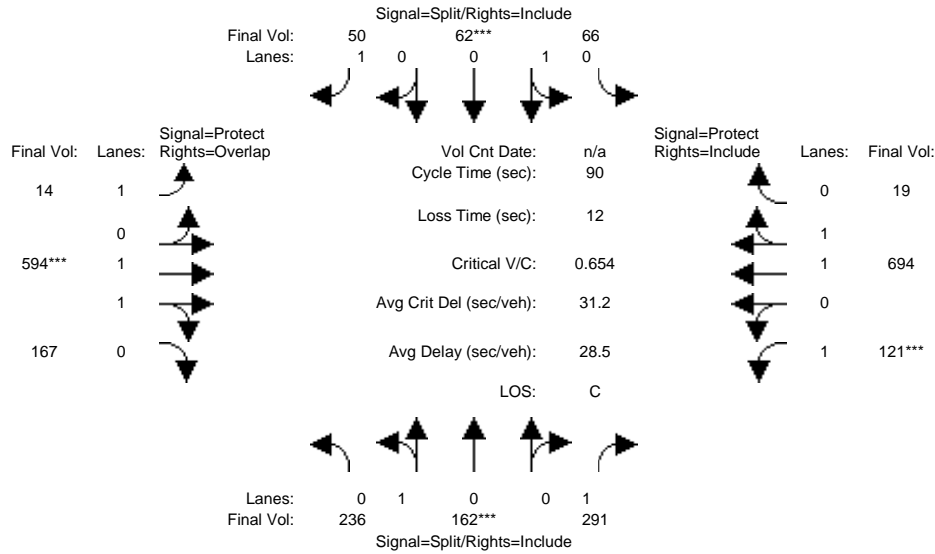

Street Name:	Tantau Avenue						Homestead Road					
	North Bound			South Bound			East Bound			West Bound		
Approach:	North Bound			South Bound			East Bound			West Bound		
Movement:	L	T	R	L	T	R	L	T	R	L	T	R
Min. Green:	10	10	10	10	10	10	7	10	10	7	10	10
Y+R:	4.0	4.0	4.0	4.0	4.0	4.0	4.0	4.0	4.0	4.0	4.0	4.0

Volume Module:												
Base Vol:	236	162	291	66	62	50	14	594	167	121	694	19
Growth Adj:	1.00	1.00	1.00	1.00	1.00	1.00	1.00	1.00	1.00	1.00	1.00	1.00
Initial Bse:	236	162	291	66	62	50	14	594	167	121	694	19
Added Vol:	0	0	0	0	0	0	0	0	0	0	0	0
PasserByVol:	0	0	0	0	0	0	0	0	0	0	0	0
Initial Fut:	236	162	291	66	62	50	14	594	167	121	694	19
User Adj:	1.00	1.00	1.00	1.00	1.00	1.00	1.00	1.00	1.00	1.00	1.00	1.00
PHF Adj:	1.00	1.00	1.00	1.00	1.00	1.00	1.00	1.00	1.00	1.00	1.00	1.00
PHF Volume:	236	162	291	66	62	50	14	594	167	121	694	19
Reduct Vol:	0	0	0	0	0	0	0	0	0	0	0	0
Reduced Vol:	236	162	291	66	62	50	14	594	167	121	694	19
PCE Adj:	1.00	1.00	1.00	1.00	1.00	1.00	1.00	1.00	1.00	1.00	1.00	1.00
MLF Adj:	1.00	1.00	1.00	1.00	1.00	1.00	1.00	1.00	1.00	1.00	1.00	1.00
Final Volume:	236	162	291	66	62	50	14	594	167	121	694	19

Saturation Flow Module:												
Sat/Lane:	1900	1900	1900	1900	1900	1900	1900	1900	1900	1900	1900	1900
Adjustment:	0.95	0.95	0.92	0.95	0.95	0.92	0.92	0.98	0.95	0.92	0.97	0.95
Lanes:	0.59	0.41	1.00	0.52	0.48	1.00	1.00	1.55	0.45	1.00	1.95	0.05
Final Sat.:	1067	733	1750	928	872	1750	1750	2887	812	1750	3601	99

Capacity Analysis Module:												
Vol/Sat:	0.22	0.22	0.17	0.07	0.07	0.03	0.01	0.21	0.21	0.07	0.19	0.19
Crit Moves:	****			****			****			****		
Green Time:	30.3	30.3	30.3	10.0	10.0	10.0	10.8	28.2	58.5	9.5	26.8	26.8
Volume/Cap:	0.66	0.66	0.49	0.64	0.64	0.26	0.07	0.66	0.32	0.66	0.65	0.65
Delay/Veh:	28.0	28.0	24.4	45.1	45.1	37.3	35.2	28.1	7.0	47.0	28.8	28.8
User DelAdj:	1.00	1.00	1.00	1.00	1.00	1.00	1.00	1.00	1.00	1.00	1.00	1.00
AdjDel/Veh:	28.0	28.0	24.4	45.1	45.1	37.3	35.2	28.1	7.0	47.0	28.8	28.8
LOS by Move:	C	C	C	D	D	D+	D+	C	A	D	C	C
HCM2kAvgQ:	11	11	7	5	5	2	0	9	5	3	8	8

Note: Queue reported is the number of cars per lane.

Hamptons Apartment Complex TIA
 SJ15-1612
 Existing AM

Level Of Service Computation Report
 2000 HCM Operations (Future Volume Alternative)
 Existing PP AM

Intersection #13: Tantau Avenue / Homestead Road

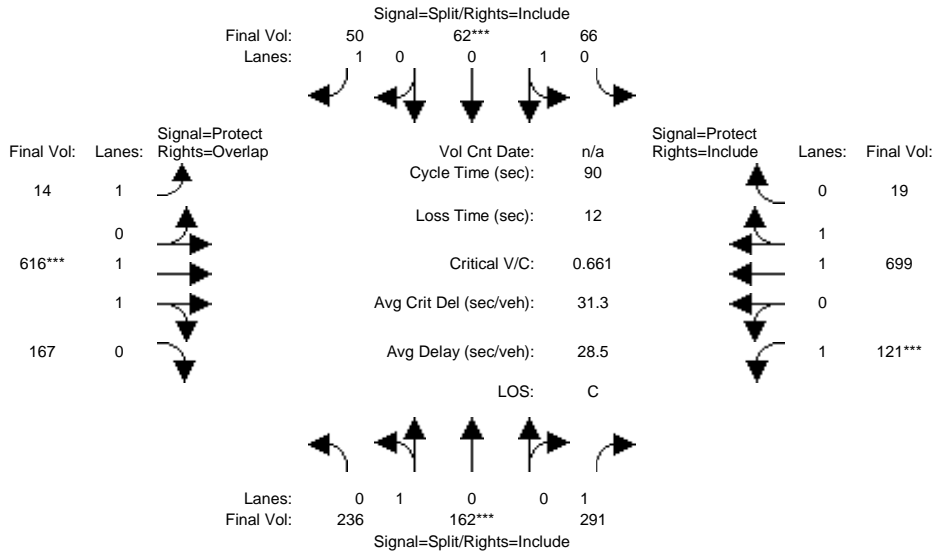

Street Name:	Tantau Avenue						Homestead Road					
Approach:	North Bound			South Bound			East Bound			West Bound		
Movement:	L	T	R	L	T	R	L	T	R	L	T	R
Min. Green:	10	10	10	10	10	10	7	10	10	7	10	10
Y+R:	4.0	4.0	4.0	4.0	4.0	4.0	4.0	4.0	4.0	4.0	4.0	4.0

Volume Module:	North Bound			South Bound			East Bound			West Bound		
Base Vol:	236	162	291	66	62	50	14	594	167	121	694	19
Growth Adj:	1.00	1.00	1.00	1.00	1.00	1.00	1.00	1.00	1.00	1.00	1.00	1.00
Initial Bse:	236	162	291	66	62	50	14	594	167	121	694	19
Added Vol:	0	0	0	0	0	0	0	22	0	0	5	0
PasserByVol:	0	0	0	0	0	0	0	0	0	0	0	0
Initial Fut:	236	162	291	66	62	50	14	616	167	121	699	19
User Adj:	1.00	1.00	1.00	1.00	1.00	1.00	1.00	1.00	1.00	1.00	1.00	1.00
PHF Adj:	1.00	1.00	1.00	1.00	1.00	1.00	1.00	1.00	1.00	1.00	1.00	1.00
PHF Volume:	236	162	291	66	62	50	14	616	167	121	699	19
Reduct Vol:	0	0	0	0	0	0	0	0	0	0	0	0
Reduced Vol:	236	162	291	66	62	50	14	616	167	121	699	19
PCE Adj:	1.00	1.00	1.00	1.00	1.00	1.00	1.00	1.00	1.00	1.00	1.00	1.00
MLF Adj:	1.00	1.00	1.00	1.00	1.00	1.00	1.00	1.00	1.00	1.00	1.00	1.00
Final Volume:	236	162	291	66	62	50	14	616	167	121	699	19

Saturation Flow Module:	North Bound			South Bound			East Bound			West Bound		
Sat/Lane:	1900	1900	1900	1900	1900	1900	1900	1900	1900	1900	1900	1900
Adjustment:	0.95	0.95	0.92	0.95	0.95	0.92	0.92	0.98	0.95	0.92	0.97	0.95
Lanes:	0.59	0.41	1.00	0.52	0.48	1.00	1.00	1.56	0.44	1.00	1.95	0.05
Final Sat.:	1067	733	1750	928	872	1750	1750	2910	789	1750	3602	98

Capacity Analysis Module:	North Bound			South Bound			East Bound			West Bound		
Vol/Sat:	0.22	0.22	0.17	0.07	0.07	0.03	0.01	0.21	0.21	0.07	0.19	0.19
Crit Moves:	****			****			****			****		
Green Time:	30.0	30.0	30.0	10.0	10.0	10.0	10.9	28.7	58.6	9.4	27.2	27.2
Volume/Cap:	0.66	0.66	0.50	0.64	0.64	0.26	0.07	0.66	0.32	0.66	0.64	0.64
Delay/Veh:	28.5	28.5	24.7	45.1	45.1	37.3	35.2	27.9	7.0	47.7	28.5	28.5
User DelAdj:	1.00	1.00	1.00	1.00	1.00	1.00	1.00	1.00	1.00	1.00	1.00	1.00
AdjDel/Veh:	28.5	28.5	24.7	45.1	45.1	37.3	35.2	27.9	7.0	47.7	28.5	28.5
LOS by Move:	C	C	C	D	D	D+	D+	C	A	D	C	C
HCM2kAvgQ:	11	11	7	5	5	2	0	10	5	3	8	8

Note: Queue reported is the number of cars per lane.

Hamptons Apartment Complex TIA
SJ15-1612
Existing AM

Level Of Service Computation Report
2000 HCM Operations (Future Volume Alternative)
Existing AM

Intersection #14: Tantau Avenue / Vallco Parkway

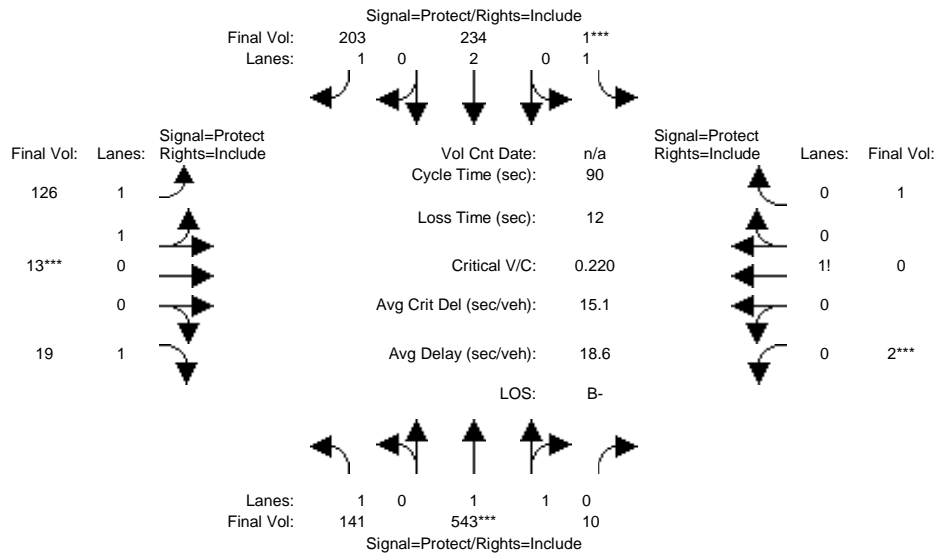

Street Name:	Tantau Avenue						Vallco Parkway					
Approach:	North Bound			South Bound			East Bound			West Bound		
Movement:	L	T	R	L	T	R	L	T	R	L	T	R
Min. Green:	7	10	10	7	10	10	7	10	10	7	10	10
Y+R:	4.0	4.0	4.0	4.0	4.0	4.0	4.0	4.0	4.0	4.0	4.0	4.0

Volume Module:	Tantau NB			Tantau SB			Vallco EB			Vallco WB		
Base Vol:	141	543	10	1	234	203	126	13	19	2	0	1
Growth Adj:	1.00	1.00	1.00	1.00	1.00	1.00	1.00	1.00	1.00	1.00	1.00	1.00
Initial Bse:	141	543	10	1	234	203	126	13	19	2	0	1
Added Vol:	0	0	0	0	0	0	0	0	0	0	0	0
PasserByVol:	0	0	0	0	0	0	0	0	0	0	0	0
Initial Fut:	141	543	10	1	234	203	126	13	19	2	0	1
User Adj:	1.00	1.00	1.00	1.00	1.00	1.00	1.00	1.00	1.00	1.00	1.00	1.00
PHF Adj:	1.00	1.00	1.00	1.00	1.00	1.00	1.00	1.00	1.00	1.00	1.00	1.00
PHF Volume:	141	543	10	1	234	203	126	13	19	2	0	1
Reduct Vol:	0	0	0	0	0	0	0	0	0	0	0	0
Reduced Vol:	141	543	10	1	234	203	126	13	19	2	0	1
PCE Adj:	1.00	1.00	1.00	1.00	1.00	1.00	1.00	1.00	1.00	1.00	1.00	1.00
MLF Adj:	1.00	1.00	1.00	1.00	1.00	1.00	1.00	1.00	1.00	1.00	1.00	1.00
Final Volume:	141	543	10	1	234	203	126	13	19	2	0	1

Saturation Flow Module:	Tantau NB			Tantau SB			Vallco EB			Vallco WB		
Sat/Lane:	1900	1900	1900	1900	1900	1900	1900	1900	1900	1900	1900	1900
Adjustment:	0.92	0.97	0.95	0.92	1.00	0.92	0.93	0.95	0.92	0.92	0.92	0.92
Lanes:	1.00	1.96	0.04	1.00	2.00	1.00	1.82	0.18	1.00	0.67	0.00	0.33
Final Sat.:	1750	3633	67	1750	3800	1750	3218	332	1750	1167	0	583

Capacity Analysis Module:	Tantau NB			Tantau SB			Vallco EB			Vallco WB		
Vol/Sat:	0.08	0.15	0.15	0.00	0.06	0.12	0.04	0.04	0.01	0.00	0.00	0.00
Crit Moves:	****			****			****			****		
Green Time:	23.7	50.7	50.7	7.0	34.1	34.1	8.4	13.3	13.3	7.0	0.0	7.0
Volume/Cap:	0.31	0.27	0.27	0.01	0.16	0.31	0.42	0.27	0.07	0.02	0.00	0.02
Delay/Veh:	27.0	10.1	10.1	38.3	18.6	19.9	39.4	34.3	33.2	38.4	0.0	38.4
User DelAdj:	1.00	1.00	1.00	1.00	1.00	1.00	1.00	1.00	1.00	1.00	1.00	1.00
AdjDel/Veh:	27.0	10.1	10.1	38.3	18.6	19.9	39.4	34.3	33.2	38.4	0.0	38.4
LOS by Move:	C	B+	B+	D+	B-	B-	D	C-	C-	D+	A	D+
HCM2kAvgQ:	3	4	4	0	2	4	2	2	0	0	0	0

Note: Queue reported is the number of cars per lane.

Hamptons Apartment Complex TIA
 SJ15-1612
 Existing AM

Level Of Service Computation Report
 2000 HCM Operations (Future Volume Alternative)
 Existing PP AM

Intersection #14: Tantau Avenue / Vallco Parkway

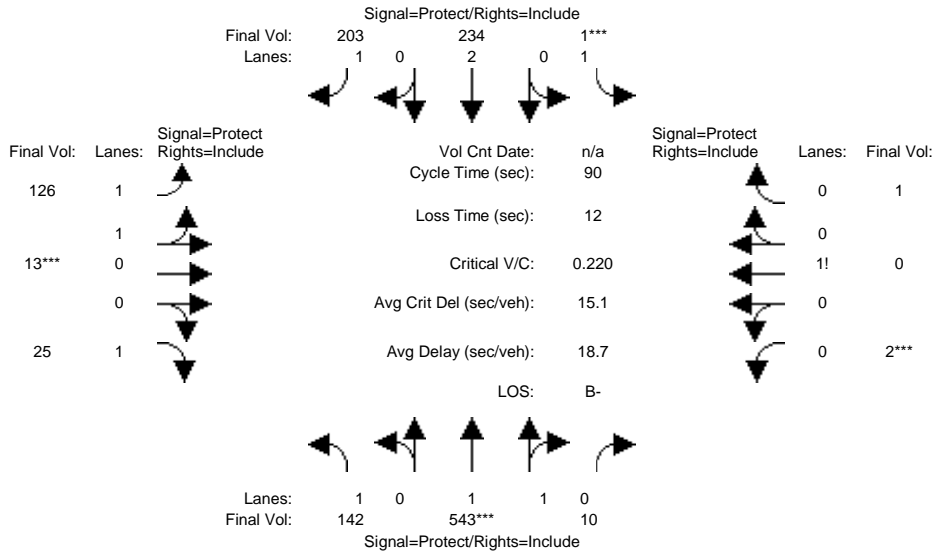

Street Name:	Tantau Avenue						Vallco Parkway					
	North Bound			South Bound			East Bound			West Bound		
Approach:	North Bound			South Bound			East Bound			West Bound		
Movement:	L	T	R	L	T	R	L	T	R	L	T	R
Min. Green:	7	10	10	7	10	10	7	10	10	7	10	10
Y+R:	4.0	4.0	4.0	4.0	4.0	4.0	4.0	4.0	4.0	4.0	4.0	4.0

Volume Module:												
Base Vol:	141	543	10	1	234	203	126	13	19	2	0	1
Growth Adj:	1.00	1.00	1.00	1.00	1.00	1.00	1.00	1.00	1.00	1.00	1.00	1.00
Initial Bse:	141	543	10	1	234	203	126	13	19	2	0	1
Added Vol:	1	0	0	0	0	0	0	0	6	0	0	0
PasserByVol:	0	0	0	0	0	0	0	0	0	0	0	0
Initial Fut:	142	543	10	1	234	203	126	13	25	2	0	1
User Adj:	1.00	1.00	1.00	1.00	1.00	1.00	1.00	1.00	1.00	1.00	1.00	1.00
PHF Adj:	1.00	1.00	1.00	1.00	1.00	1.00	1.00	1.00	1.00	1.00	1.00	1.00
PHF Volume:	142	543	10	1	234	203	126	13	25	2	0	1
Reduct Vol:	0	0	0	0	0	0	0	0	0	0	0	0
Reduced Vol:	142	543	10	1	234	203	126	13	25	2	0	1
PCE Adj:	1.00	1.00	1.00	1.00	1.00	1.00	1.00	1.00	1.00	1.00	1.00	1.00
MLF Adj:	1.00	1.00	1.00	1.00	1.00	1.00	1.00	1.00	1.00	1.00	1.00	1.00
Final Volume:	142	543	10	1	234	203	126	13	25	2	0	1

Saturation Flow Module:												
Sat/Lane:	1900	1900	1900	1900	1900	1900	1900	1900	1900	1900	1900	1900
Adjustment:	0.92	0.97	0.95	0.92	1.00	0.92	0.93	0.95	0.92	0.92	0.92	0.92
Lanes:	1.00	1.96	0.04	1.00	2.00	1.00	1.82	0.18	1.00	0.67	0.00	0.33
Final Sat.:	1750	3633	67	1750	3800	1750	3218	332	1750	1167	0	583

Capacity Analysis Module:												
Vol/Sat:	0.08	0.15	0.15	0.00	0.06	0.12	0.04	0.04	0.01	0.00	0.00	0.00
Crit Moves:	****			****			****			****		
Green Time:	23.8	50.7	50.7	7.0	34.0	34.0	8.4	13.3	13.3	7.0	0.0	7.0
Volume/Cap:	0.31	0.27	0.27	0.01	0.16	0.31	0.42	0.27	0.10	0.02	0.00	0.02
Delay/Veh:	26.9	10.1	10.1	38.3	18.6	20.0	39.4	34.3	33.3	38.4	0.0	38.4
User DelAdj:	1.00	1.00	1.00	1.00	1.00	1.00	1.00	1.00	1.00	1.00	1.00	1.00
AdjDel/Veh:	26.9	10.1	10.1	38.3	18.6	20.0	39.4	34.3	33.3	38.4	0.0	38.4
LOS by Move:	C	B+	B+	D+	B-	C+	D	C-	C-	D+	A	D+
HCM2kAvgQ:	3	4	4	0	2	4	2	2	1	0	0	0

Note: Queue reported is the number of cars per lane.

Hamptons Apartment Complex TIA
 SJ15-1612
 Existing AM

Level Of Service Computation Report
 2000 HCM Operations (Future Volume Alternative)
 Existing AM

Intersection #15: Tantau Avenue / Stevens Creek Boulevard

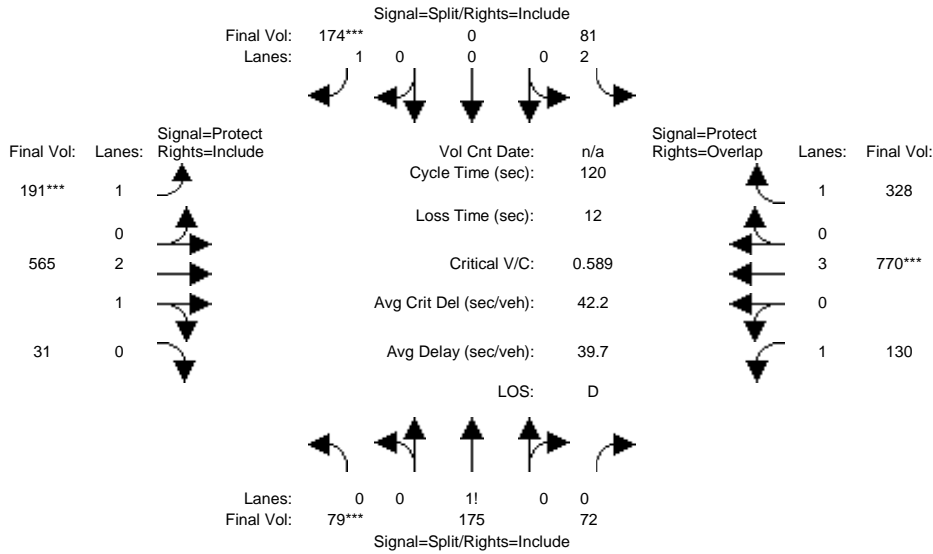

Street Name:	Tantau Avenue						Stevens Creek Boulevard					
	North Bound			South Bound			East Bound			West Bound		
Approach:												
Movement:	L	T	R	L	T	R	L	T	R	L	T	R
Min. Green:	10	10	10	10	10	10	7	10	10	7	10	10
Y+R:	4.0	4.0	4.0	4.0	4.0	4.0	4.0	4.0	4.0	4.0	4.0	4.0

Volume Module:												
Base Vol:	79	175	72	81	0	174	191	565	31	130	770	328
Growth Adj:	1.00	1.00	1.00	1.00	1.00	1.00	1.00	1.00	1.00	1.00	1.00	1.00
Initial Bse:	79	175	72	81	0	174	191	565	31	130	770	328
Added Vol:	0	0	0	0	0	0	0	0	0	0	0	0
PasserByVol:	0	0	0	0	0	0	0	0	0	0	0	0
Initial Fut:	79	175	72	81	0	174	191	565	31	130	770	328
User Adj:	1.00	1.00	1.00	1.00	1.00	1.00	1.00	1.00	1.00	1.00	1.00	1.00
PHF Adj:	1.00	1.00	1.00	1.00	1.00	1.00	1.00	1.00	1.00	1.00	1.00	1.00
PHF Volume:	79	175	72	81	0	174	191	565	31	130	770	328
Reduct Vol:	0	0	0	0	0	0	0	0	0	0	0	0
Reduced Vol:	79	175	72	81	0	174	191	565	31	130	770	328
PCE Adj:	1.00	1.00	1.00	1.00	1.00	1.00	1.00	1.00	1.00	1.00	1.00	1.00
MLF Adj:	1.00	1.00	1.00	1.00	1.00	1.00	1.00	1.00	1.00	1.00	1.00	1.00
Final Volume:	79	175	72	81	0	174	191	565	31	130	770	328

Saturation Flow Module:												
Sat/Lane:	1900	1900	1900	1900	1900	1900	1900	1900	1900	1900	1900	1900
Adjustment:	0.92	0.92	0.92	0.83	1.00	0.92	0.92	0.98	0.95	0.92	1.00	0.92
Lanes:	0.24	0.54	0.22	2.00	0.00	1.00	1.00	2.84	0.16	1.00	3.00	1.00
Final Sat.:	424	939	387	3150	0	1750	1750	5308	291	1750	5700	1750

Capacity Analysis Module:												
Vol/Sat:	0.19	0.19	0.19	0.03	0.00	0.10	0.11	0.11	0.11	0.07	0.14	0.19
Crit Moves:	***					***	***				***	
Green Time:	38.0	38.0	38.0	20.3	0.0	20.3	22.2	29.3	29.3	20.5	27.5	47.8
Volume/Cap:	0.59	0.59	0.59	0.15	0.00	0.59	0.59	0.44	0.44	0.44	0.59	0.47
Delay/Veh:	36.1	36.1	36.1	42.7	0.0	49.1	47.5	38.6	38.6	45.6	41.9	27.2
User DelAdj:	1.00	1.00	1.00	1.00	1.00	1.00	1.00	1.00	1.00	1.00	1.00	1.00
AdjDel/Veh:	36.1	36.1	36.1	42.7	0.0	49.1	47.5	38.6	38.6	45.6	41.9	27.2
LOS by Move:	D+	D+	D+	D	A	D	D	D+	D+	D	D	C
HCM2kAvgQ:	11	11	11	1	0	6	7	6	6	5	9	10

Note: Queue reported is the number of cars per lane.

Hamptons Apartment Complex TIA
 SJ15-1612
 Existing AM

Level Of Service Computation Report
 2000 HCM Operations (Future Volume Alternative)
 Existing PP AM

Intersection #15: Tantau Avenue / Stevens Creek Boulevard

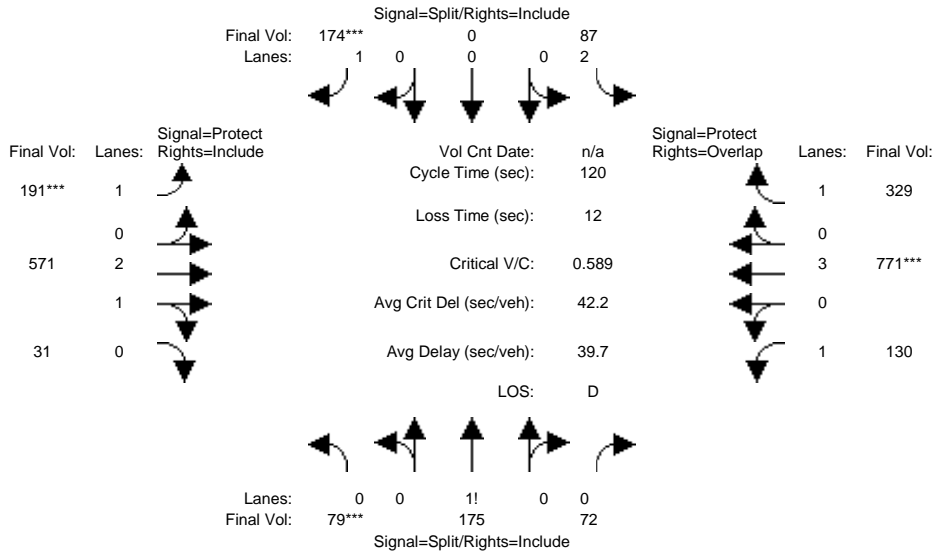

Street Name:	Tantau Avenue						Stevens Creek Boulevard					
	North Bound			South Bound			East Bound			West Bound		
Approach:	North Bound			South Bound			East Bound			West Bound		
Movement:	L	T	R	L	T	R	L	T	R	L	T	R
Min. Green:	10	10	10	10	10	10	7	10	10	7	10	10
Y+R:	4.0	4.0	4.0	4.0	4.0	4.0	4.0	4.0	4.0	4.0	4.0	4.0

Volume Module:												
Base Vol:	79	175	72	81	0	174	191	565	31	130	770	328
Growth Adj:	1.00	1.00	1.00	1.00	1.00	1.00	1.00	1.00	1.00	1.00	1.00	1.00
Initial Bse:	79	175	72	81	0	174	191	565	31	130	770	328
Added Vol:	0	0	0	6	0	0	0	6	0	0	1	1
PasserByVol:	0	0	0	0	0	0	0	0	0	0	0	0
Initial Fut:	79	175	72	87	0	174	191	571	31	130	771	329
User Adj:	1.00	1.00	1.00	1.00	1.00	1.00	1.00	1.00	1.00	1.00	1.00	1.00
PHF Adj:	1.00	1.00	1.00	1.00	1.00	1.00	1.00	1.00	1.00	1.00	1.00	1.00
PHF Volume:	79	175	72	87	0	174	191	571	31	130	771	329
Reduct Vol:	0	0	0	0	0	0	0	0	0	0	0	0
Reduced Vol:	79	175	72	87	0	174	191	571	31	130	771	329
PCE Adj:	1.00	1.00	1.00	1.00	1.00	1.00	1.00	1.00	1.00	1.00	1.00	1.00
MLF Adj:	1.00	1.00	1.00	1.00	1.00	1.00	1.00	1.00	1.00	1.00	1.00	1.00
Final Volume:	79	175	72	87	0	174	191	571	31	130	771	329

Saturation Flow Module:												
Sat/Lane:	1900	1900	1900	1900	1900	1900	1900	1900	1900	1900	1900	1900
Adjustment:	0.92	0.92	0.92	0.83	1.00	0.92	0.92	0.98	0.95	0.92	1.00	0.92
Lanes:	0.24	0.54	0.22	2.00	0.00	1.00	1.00	2.84	0.16	1.00	3.00	1.00
Final Sat.:	424	939	387	3150	0	1750	1750	5311	288	1750	5700	1750

Capacity Analysis Module:												
Vol/Sat:	0.19	0.19	0.19	0.03	0.00	0.10	0.11	0.11	0.11	0.07	0.14	0.19
Crit Moves:	***					***	***				***	
Green Time:	38.0	38.0	38.0	20.3	0.0	20.3	22.2	29.4	29.4	20.3	27.6	47.8
Volume/Cap:	0.59	0.59	0.59	0.16	0.00	0.59	0.59	0.44	0.44	0.44	0.59	0.47
Delay/Veh:	36.1	36.1	36.1	42.8	0.0	49.1	47.5	38.5	38.5	45.7	41.9	27.2
User DelAdj:	1.00	1.00	1.00	1.00	1.00	1.00	1.00	1.00	1.00	1.00	1.00	1.00
AdjDel/Veh:	36.1	36.1	36.1	42.8	0.0	49.1	47.5	38.5	38.5	45.7	41.9	27.2
LOS by Move:	D+	D+	D+	D	A	D	D	D+	D+	D	D	C
HCM2kAvgQ:	11	11	11	2	0	6	7	6	6	5	9	10

Note: Queue reported is the number of cars per lane.

Hamptons Apartment Complex TIA
SJ15-1612
Existing AM

Level Of Service Computation Report
2000 HCM Operations (Future Volume Alternative)
Existing AM

Intersection #16: Lawrence Expressway / Homestead Road

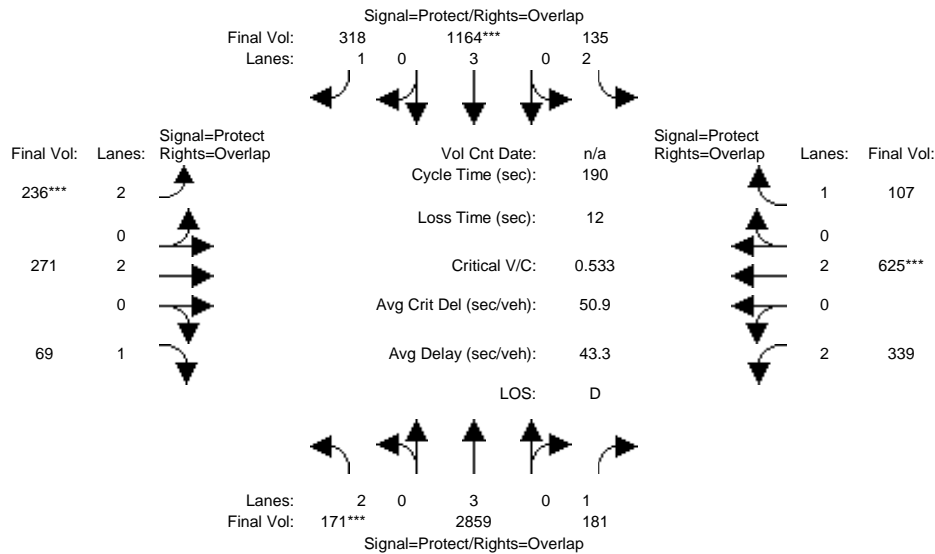

Street Name:	Lawrence Expressway						Homestead Road					
	North Bound			South Bound			East Bound			West Bound		
Approach:												
Movement:	L	T	R	L	T	R	L	T	R	L	T	R
Min. Green:	14	85	10	14	107	10	14	10	10	14	10	10
Y+R:	4.0	4.0	4.0	4.0	4.0	4.0	4.0	4.0	4.0	4.0	4.0	4.0

Volume Module:												
Base Vol:	171	3363	181	135	1369	318	236	271	69	339	625	107
Growth Adj:	1.00	1.00	1.00	1.00	1.00	1.00	1.00	1.00	1.00	1.00	1.00	1.00
Initial Bse:	171	3363	181	135	1369	318	236	271	69	339	625	107
Added Vol:	0	0	0	0	0	0	0	0	0	0	0	0
PasserByVol:	0	0	0	0	0	0	0	0	0	0	0	0
Initial Fut:	171	3363	181	135	1369	318	236	271	69	339	625	107
User Adj:	1.00	0.85	1.00	1.00	0.85	1.00	1.00	1.00	1.00	1.00	1.00	1.00
PHF Adj:	1.00	1.00	1.00	1.00	1.00	1.00	1.00	1.00	1.00	1.00	1.00	1.00
PHF Volume:	171	2859	181	135	1164	318	236	271	69	339	625	107
Reduct Vol:	0	0	0	0	0	0	0	0	0	0	0	0
Reduced Vol:	171	2859	181	135	1164	318	236	271	69	339	625	107
PCE Adj:	1.00	1.00	1.00	1.00	1.00	1.00	1.00	1.00	1.00	1.00	1.00	1.00
MLF Adj:	1.00	1.00	1.00	1.00	1.00	1.00	1.00	1.00	1.00	1.00	1.00	1.00
Final Volume:	171	2859	181	135	1164	318	236	271	69	339	625	107

Saturation Flow Module:												
Sat/Lane:	1900	1900	1900	1900	1900	1900	1900	1900	1900	1900	1900	1900
Adjustment:	0.83	1.00	0.92	0.83	1.00	0.92	0.83	1.00	0.92	0.83	1.00	0.92
Lanes:	2.00	3.00	1.00	2.00	3.00	1.00	2.00	2.00	1.00	2.00	2.00	1.00
Final Sat.:	3150	5700	1750	3150	5700	1750	3150	3800	1750	3150	3800	1750

Capacity Analysis Module:												
Vol/Sat:	0.05	0.50	0.10	0.04	0.20	0.18	0.07	0.07	0.04	0.11	0.16	0.06
Crit Moves:	***			****			****			****		
Green Time:	14.8	111	140.4	17.1	113	128.5	15.5	19.8	34.6	29.8	34.1	51.2
Volume/Cap:	0.70	0.86	0.14	0.47	0.34	0.27	0.92	0.69	0.22	0.69	0.92	0.23
Delay/Veh:	89.5	34.1	6.9	79.1	11.0	4.2	116.7	82.7	63.1	75.6	89.8	51.4
User DelAdj:	1.00	1.00	1.00	1.00	1.00	1.00	1.00	1.00	1.00	1.00	1.00	1.00
AdjDel/Veh:	89.5	34.1	6.9	79.1	11.0	4.2	116.7	82.7	63.1	75.6	89.8	51.4
LOS by Move:	F	C-	A	E-	B+	A	F	F	E	E-	F	D-
HCM2kAvgQ:	7	45	3	5	6	3	9	7	4	12	20	6

Note: Queue reported is the number of cars per lane.

Hamptons Apartment Complex TIA
 SJ15-1612
 Existing AM

Level Of Service Computation Report
 2000 HCM Operations (Future Volume Alternative)
 Existing PP AM

Intersection #16: Lawrence Expressway / Homestead Road

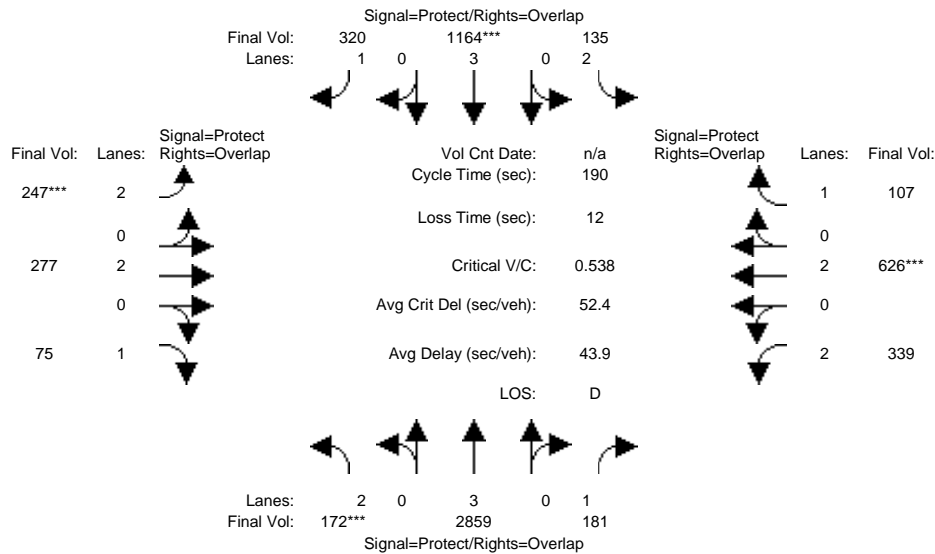

Street Name:	Lawrence Expressway						Homestead Road					
	North Bound			South Bound			East Bound			West Bound		
Approach:	North Bound			South Bound			East Bound			West Bound		
Movement:	L	T	R	L	T	R	L	T	R	L	T	R
Min. Green:	14	85	10	14	107	10	14	10	10	14	10	10
Y+R:	4.0	4.0	4.0	4.0	4.0	4.0	4.0	4.0	4.0	4.0	4.0	4.0

Volume Module:												
Base Vol:	171	3363	181	135	1369	318	236	271	69	339	625	107
Growth Adj:	1.00	1.00	1.00	1.00	1.00	1.00	1.00	1.00	1.00	1.00	1.00	1.00
Initial Bse:	171	3363	181	135	1369	318	236	271	69	339	625	107
Added Vol:	1	0	0	0	0	2	11	6	6	0	1	0
PasserByVol:	0	0	0	0	0	0	0	0	0	0	0	0
Initial Fut:	172	3363	181	135	1369	320	247	277	75	339	626	107
User Adj:	1.00	0.85	1.00	1.00	0.85	1.00	1.00	1.00	1.00	1.00	1.00	1.00
PHF Adj:	1.00	1.00	1.00	1.00	1.00	1.00	1.00	1.00	1.00	1.00	1.00	1.00
PHF Volume:	172	2859	181	135	1164	320	247	277	75	339	626	107
Reduct Vol:	0	0	0	0	0	0	0	0	0	0	0	0
Reduced Vol:	172	2859	181	135	1164	320	247	277	75	339	626	107
PCE Adj:	1.00	1.00	1.00	1.00	1.00	1.00	1.00	1.00	1.00	1.00	1.00	1.00
MLF Adj:	1.00	1.00	1.00	1.00	1.00	1.00	1.00	1.00	1.00	1.00	1.00	1.00
Final Volume:	172	2859	181	135	1164	320	247	277	75	339	626	107

Saturation Flow Module:												
Sat/Lane:	1900	1900	1900	1900	1900	1900	1900	1900	1900	1900	1900	1900
Adjustment:	0.83	1.00	0.92	0.83	1.00	0.92	0.83	1.00	0.92	0.83	1.00	0.92
Lanes:	2.00	3.00	1.00	2.00	3.00	1.00	2.00	2.00	1.00	2.00	2.00	1.00
Final Sat.:	3150	5700	1750	3150	5700	1750	3150	3800	1750	3150	3800	1750

Capacity Analysis Module:												
Vol/Sat:	0.05	0.50	0.10	0.04	0.20	0.18	0.08	0.07	0.04	0.11	0.16	0.06
Crit Moves:	***			****			****			****		
Green Time:	14.8	111	140.2	17.1	113	128.9	16.0	20.0	34.8	29.6	33.6	50.8
Volume/Cap:	0.70	0.86	0.14	0.47	0.34	0.27	0.93	0.69	0.23	0.69	0.93	0.23
Delay/Veh:	89.8	34.1	7.0	79.1	11.0	4.0	119.1	82.8	63.1	76.1	92.7	51.7
User DelAdj:	1.00	1.00	1.00	1.00	1.00	1.00	1.00	1.00	1.00	1.00	1.00	1.00
AdjDel/Veh:	89.8	34.1	7.0	79.1	11.0	4.0	119.1	82.8	63.1	76.1	92.7	51.7
LOS by Move:	F	C-	A	E-	B+	A	F	F	E	E-	F	D-
HCM2kAvgQ:	7	45	3	5	6	3	9	7	4	12	21	6

Note: Queue reported is the number of cars per lane.

Hamptons Apartments Complex TIA
 SJ15-1612
 Existing PM / Existing PP PM

Summary Scenario Comparison Report (With Average Critical Delay)
 Future Volume Alternative

Intersection	???				Existing PM				Existing PP PM					???				
	LOS	Avg Del (sec)	Crit V/C	Avg Crit Del (sec)	LOS	Avg Del (sec)	Crit V/C	Avg Crit Del (sec)	LOS	Avg Del (sec)	Crit V/C	Crit V/C Change	Avg Crit Del (sec)	Avg Crit Del Change	LOS	Avg Del (sec)	Crit V/C	Avg Crit Del (sec)
#1 Wolfe Road / El Camino Real	?	xx.x	x.xxx	xx.x	D+	38.4	0.699	41.5	D+	38.6	0.705	+ 0.006	41.8	+ 0.3	?	xx.x	x.xxx	xx.x
#2 Wolfe Road / Fremont Avenue	?	xx.x	x.xxx	xx.x	D+	36.4	0.687	34.2	D+	36.7	0.696	+ 0.008	34.4	+ 0.2	?	xx.x	x.xxx	xx.x
#3 Wolfe Road / Marion Way	?	xx.x	x.xxx	xx.x	C+	21.5	0.557	32.1	C+	21.4	0.563	+ 0.007	31.9	- 0.1	?	xx.x	x.xxx	xx.x
#4 Wolfe Road / Inverness Avenue	?	xx.x	x.xxx	xx.x	B	17.8	0.494	15.1	B	17.6	0.506	+ 0.012	15.0	- 0.1	?	xx.x	x.xxx	xx.x
#5 Wolfe Road / Homestead Road	?	xx.x	x.xxx	xx.x	D+	36.4	0.624	37.5	D+	37.4	0.657	+ 0.033	38.8	+ 1.3	?	xx.x	x.xxx	xx.x
#6 Wolfe Road / Apple Campus 2	?	xx.x	x.xxx	xx.x	A	0.9	0.333	0.9	A	0.9	0.351	+ 0.018	0.9	+ 0.0	?	xx.x	x.xxx	xx.x
#7 Wolfe Road / Pruneridge Avenue	?	xx.x	x.xxx	xx.x	B-	19.6	0.507	22.3	C	24.5	0.582	+ 0.075	26.4	+ 4.1	?	xx.x	x.xxx	xx.x
#8 Wolfe Road / I-280 NB Ramps	?	xx.x	x.xxx	xx.x	C+	22.7	0.627	25.0	C	23.3	0.663	+ 0.036	25.8	+ 0.8	?	xx.x	x.xxx	xx.x
#9 Wolfe Road / I-280 SB Ramps	?	xx.x	x.xxx	xx.x	B+	12.0	0.423	13.7	B	12.4	0.439	+ 0.015	13.4	- 0.3	?	xx.x	x.xxx	xx.x
#10 Wolfe Road / Vallco Parkway	?	xx.x	x.xxx	xx.x	C	28.5	0.487	26.7	C	28.5	0.494	+ 0.008	26.7	+ 0.0	?	xx.x	x.xxx	xx.x
#11 Wolfe Road / Stevens Creek Boulevard	?	xx.x	x.xxx	xx.x	D	42.8	0.761	46.3	D	43.1	0.774	+ 0.013	46.9	+ 0.6	?	xx.x	x.xxx	xx.x
#12 De Anza Boulevard / Stevens Creek Boulevard	?	xx.x	x.xxx	xx.x	D	44.6	0.882	47.6	D	44.7	0.882	+ 0.000	47.6	+ 0.0	?	xx.x	x.xxx	xx.x
#13 Tantau Avenue / Homestead Road	?	xx.x	x.xxx	xx.x	D+	36.8	0.856	44.3	D+	37.0	0.861	+ 0.005	44.7	+ 0.4	?	xx.x	x.xxx	xx.x
#14 Tantau Avenue / Vallco Parkway	?	xx.x	x.xxx	xx.x	C	24.0	0.310	22.0	C	24.4	0.317	+ 0.007	22.6	+ 0.6	?	xx.x	x.xxx	xx.x
#15 Tantau Avenue / Stevens Creek Boulevard	?	xx.x	x.xxx	xx.x	D+	38.2	0.691	39.9	D+	38.1	0.693	+ 0.002	39.9	+ 0.1	?	xx.x	x.xxx	xx.x
#16 Lawrence Expressway / Homestead Road	?	xx.x	x.xxx	xx.x	D	48.3	0.780	50.5	D	48.9	0.784	+ 0.004	51.0	+ 0.5	?	xx.x	x.xxx	xx.x

Hamptons Apartments Complex TIA
 SJ15-1612
 Existing PM

Level Of Service Computation Report
 2000 HCM Operations (Future Volume Alternative)
 Existing PM

Intersection #0:

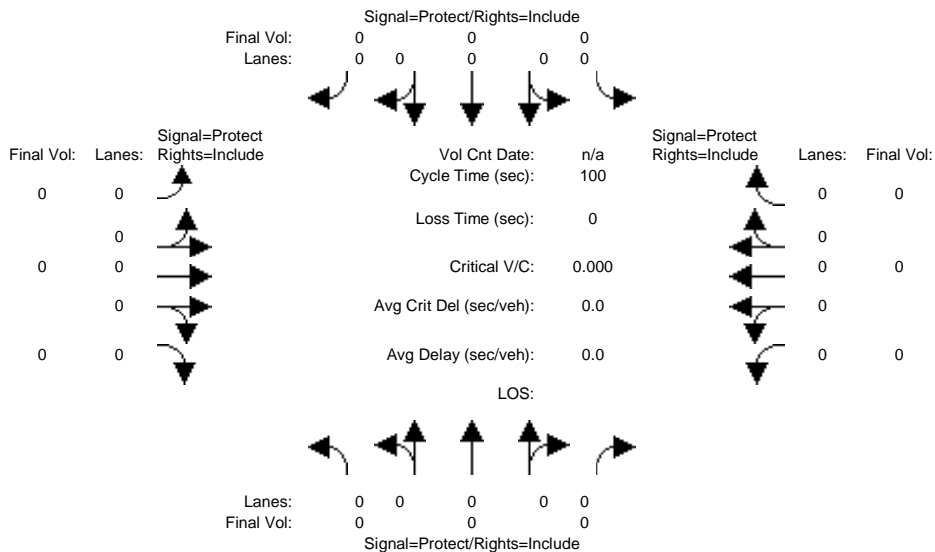

Approach:	North Bound			South Bound			East Bound			West Bound		
	L	T	R	L	T	R	L	T	R	L	T	R
Min. Green:	7	10	10	7	10	10	7	10	10	7	10	10
Y+R:	4.0	4.0	4.0	4.0	4.0	4.0	4.0	4.0	4.0	4.0	4.0	4.0

Volume Module:												
Base Vol:	0	0	0	0	0	0	0	0	0	0	0	0
Growth Adj:	0.00	0.00	0.00	0.00	0.00	0.00	0.00	0.00	0.00	0.00	0.00	0.00
Initial Bse:	0	0	0	0	0	0	0	0	0	0	0	0
Added Vol:	0	0	0	0	0	0	0	0	0	0	0	0
PasserByVol:	0	0	0	0	0	0	0	0	0	0	0	0
Initial Fut:	0	0	0	0	0	0	0	0	0	0	0	0
User Adj:	0.00	0.00	0.00	0.00	0.00	0.00	0.00	0.00	0.00	0.00	0.00	0.00
PHF Adj:	0.00	0.00	0.00	0.00	0.00	0.00	0.00	0.00	0.00	0.00	0.00	0.00
PHF Volume:	0	0	0	0	0	0	0	0	0	0	0	0
Reduct Vol:	0	0	0	0	0	0	0	0	0	0	0	0
Reduced Vol:	0	0	0	0	0	0	0	0	0	0	0	0
PCE Adj:	0.00	0.00	0.00	0.00	0.00	0.00	0.00	0.00	0.00	0.00	0.00	0.00
MLF Adj:	0.00	0.00	0.00	0.00	0.00	0.00	0.00	0.00	0.00	0.00	0.00	0.00
Final Volume:	0	0	0	0	0	0	0	0	0	0	0	0

Saturation Flow Module:												
Sat/Lane:	0	0	0	0	0	0	0	0	0	0	0	0
Adjustment:	1.00	1.00	1.00	1.00	1.00	1.00	1.00	1.00	1.00	1.00	1.00	1.00
Lanes:	0.00	0.00	0.00	0.00	0.00	0.00	0.00	0.00	0.00	0.00	0.00	0.00
Final Sat.:	0	0	0	0	0	0	0	0	0	0	0	0

Capacity Analysis Module:												
Vol/Sat:	0.00	0.00	0.00	0.00	0.00	0.00	0.00	0.00	0.00	0.00	0.00	0.00
Crit Moves:												
Green Time:	0.0	0.0	0.0	0.0	0.0	0.0	0.0	0.0	0.0	0.0	0.0	0.0
Volume/Cap:	0.00	0.00	0.00	0.00	0.00	0.00	0.00	0.00	0.00	0.00	0.00	0.00
Delay/Veh:	0.0	0.0	0.0	0.0	0.0	0.0	0.0	0.0	0.0	0.0	0.0	0.0
User DelAdj:	1.00	1.00	1.00	1.00	1.00	1.00	1.00	1.00	1.00	1.00	1.00	1.00
AdjDel/Veh:	0.0	0.0	0.0	0.0	0.0	0.0	0.0	0.0	0.0	0.0	0.0	0.0
LOS by Move:												
HCM2kAvgQ:	0	0	0	0	0	0	0	0	0	0	0	0

Note: Queue reported is the number of cars per lane.

Hamptons Apartments Complex TIA
 SJ15-1612
 Existing PM

Level Of Service Computation Report
 2000 HCM Operations (Future Volume Alternative)
 Existing PP PM

Intersection #0:

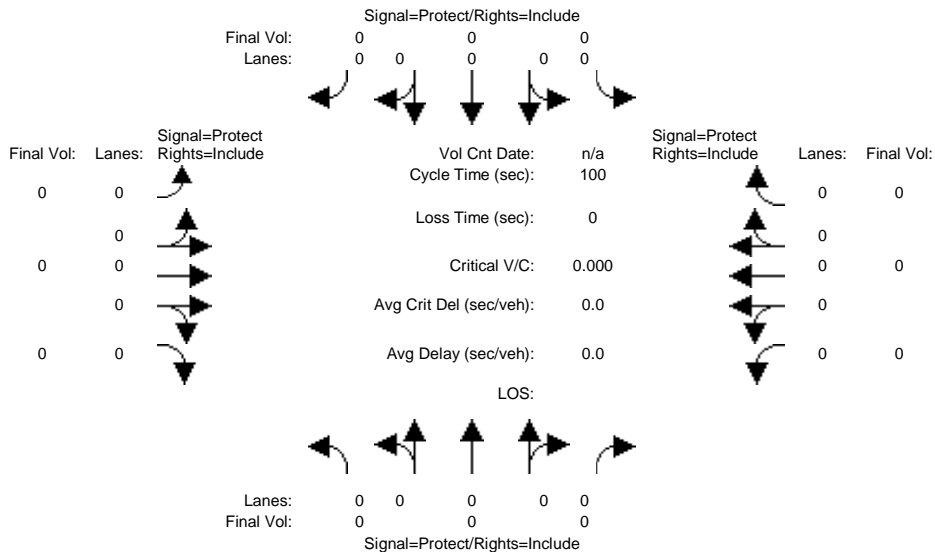

Approach:	North Bound			South Bound			East Bound			West Bound		
	L	T	R	L	T	R	L	T	R	L	T	R
Min. Green:	7	10	10	7	10	10	7	10	10	7	10	10
Y+R:	4.0	4.0	4.0	4.0	4.0	4.0	4.0	4.0	4.0	4.0	4.0	4.0

Volume Module:

Base Vol:	0	0	0	0	0	0	0	0	0	0	0	0
Growth Adj:	0.00	0.00	0.00	0.00	0.00	0.00	0.00	0.00	0.00	0.00	0.00	0.00
Initial Bse:	0	0	0	0	0	0	0	0	0	0	0	0
Added Vol:	0	0	0	0	0	0	0	0	0	0	0	0
PasserByVol:	0	0	0	0	0	0	0	0	0	0	0	0
Initial Fut:	0	0	0	0	0	0	0	0	0	0	0	0
User Adj:	0.00	0.00	0.00	0.00	0.00	0.00	0.00	0.00	0.00	0.00	0.00	0.00
PHF Adj:	0.00	0.00	0.00	0.00	0.00	0.00	0.00	0.00	0.00	0.00	0.00	0.00
PHF Volume:	0	0	0	0	0	0	0	0	0	0	0	0
Reduct Vol:	0	0	0	0	0	0	0	0	0	0	0	0
Reduced Vol:	0	0	0	0	0	0	0	0	0	0	0	0
PCE Adj:	0.00	0.00	0.00	0.00	0.00	0.00	0.00	0.00	0.00	0.00	0.00	0.00
MLF Adj:	0.00	0.00	0.00	0.00	0.00	0.00	0.00	0.00	0.00	0.00	0.00	0.00
FinalVolume:	0	0	0	0	0	0	0	0	0	0	0	0

Saturation Flow Module:

Sat/Lane:	0	0	0	0	0	0	0	0	0	0	0	0
Adjustment:	1.00	1.00	1.00	1.00	1.00	1.00	1.00	1.00	1.00	1.00	1.00	1.00
Lanes:	0.00	0.00	0.00	0.00	0.00	0.00	0.00	0.00	0.00	0.00	0.00	0.00
Final Sat.:	0	0	0	0	0	0	0	0	0	0	0	0

Capacity Analysis Module:

Vol/Sat:	0.00	0.00	0.00	0.00	0.00	0.00	0.00	0.00	0.00	0.00	0.00	0.00
Crit Moves:												
Green Time:	0.0	0.0	0.0	0.0	0.0	0.0	0.0	0.0	0.0	0.0	0.0	0.0
Volume/Cap:	0.00	0.00	0.00	0.00	0.00	0.00	0.00	0.00	0.00	0.00	0.00	0.00
Delay/Veh:	0.0	0.0	0.0	0.0	0.0	0.0	0.0	0.0	0.0	0.0	0.0	0.0
User DelAdj:	1.00	1.00	1.00	1.00	1.00	1.00	1.00	1.00	1.00	1.00	1.00	1.00
AdjDel/Veh:	0.0	0.0	0.0	0.0	0.0	0.0	0.0	0.0	0.0	0.0	0.0	0.0
LOS by Move:												
HCM2kAvgQ:	0	0	0	0	0	0	0	0	0	0	0	0

Note: Queue reported is the number of cars per lane.

Hamptons Apartments Complex TIA
 SJ15-1612
 Existing PM

Level Of Service Computation Report
 2000 HCM Operations (Future Volume Alternative)
 Existing PM

Intersection #1: Wolfe Road / El Camino Real

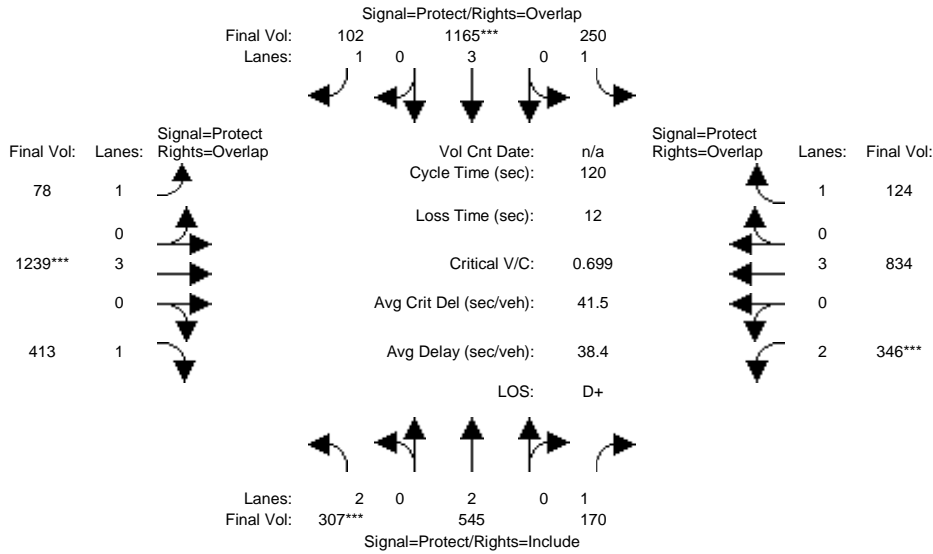

Street Name:	Wolfe Road						El Camino Real					
	North Bound			South Bound			East Bound			West Bound		
Approach:	North Bound			South Bound			East Bound			West Bound		
Movement:	L	T	R	L	T	R	L	T	R	L	T	R
Min. Green:	7	10	10	7	10	10	7	10	10	7	10	10
Y+R:	4.0	4.0	4.0	4.0	4.0	4.0	4.0	4.0	4.0	4.0	4.0	4.0

Volume Module:												
Base Vol:	307	545	170	250	1165	102	78	1239	413	346	834	124
Growth Adj:	1.00	1.00	1.00	1.00	1.00	1.00	1.00	1.00	1.00	1.00	1.00	1.00
Initial Bse:	307	545	170	250	1165	102	78	1239	413	346	834	124
Added Vol:	0	0	0	0	0	0	0	0	0	0	0	0
PasserByVol:	0	0	0	0	0	0	0	0	0	0	0	0
Initial Fut:	307	545	170	250	1165	102	78	1239	413	346	834	124
User Adj:	1.00	1.00	1.00	1.00	1.00	1.00	1.00	1.00	1.00	1.00	1.00	1.00
PHF Adj:	1.00	1.00	1.00	1.00	1.00	1.00	1.00	1.00	1.00	1.00	1.00	1.00
PHF Volume:	307	545	170	250	1165	102	78	1239	413	346	834	124
Reduct Vol:	0	0	0	0	0	0	0	0	0	0	0	0
Reduced Vol:	307	545	170	250	1165	102	78	1239	413	346	834	124
PCE Adj:	1.00	1.00	1.00	1.00	1.00	1.00	1.00	1.00	1.00	1.00	1.00	1.00
MLF Adj:	1.00	1.00	1.00	1.00	1.00	1.00	1.00	1.00	1.00	1.00	1.00	1.00
Final Volume:	307	545	170	250	1165	102	78	1239	413	346	834	124

Saturation Flow Module:												
Sat/Lane:	1900	1900	1900	1900	1900	1900	1900	1900	1900	1900	1900	1900
Adjustment:	0.83	1.00	0.92	0.92	1.00	0.92	0.92	1.00	0.92	0.83	1.00	0.92
Lanes:	2.00	2.00	1.00	1.00	3.00	1.00	1.00	3.00	1.00	2.00	3.00	1.00
Final Sat.:	3150	3800	1750	1750	5700	1750	1750	5700	1750	3150	5700	1750

Capacity Analysis Module:												
Vol/Sat:	0.10	0.14	0.10	0.14	0.20	0.06	0.04	0.22	0.24	0.11	0.15	0.07
Crit Moves:	***			****			****			****		
Green Time:	16.7	26.0	26.0	25.9	35.1	51.1	16.0	37.3	54.1	18.9	40.2	66.0
Volume/Cap:	0.70	0.66	0.45	0.66	0.70	0.14	0.33	0.70	0.52	0.70	0.44	0.13
Delay/Veh:	54.2	45.1	41.7	47.5	39.1	21.1	48.0	37.7	24.4	52.3	31.3	13.1
User DelAdj:	1.00	1.00	1.00	1.00	1.00	1.00	1.00	1.00	1.00	1.00	1.00	1.00
AdjDel/Veh:	54.2	45.1	41.7	47.5	39.1	21.1	48.0	37.7	24.4	52.3	31.3	13.1
LOS by Move:	D-	D	D	D	D	C+	D	D+	C	D-	C	B
HCM2kAvgQ:	6	9	6	10	14	2	3	14	12	9	8	2

Note: Queue reported is the number of cars per lane.

Hamptons Apartments Complex TIA
 SJ15-1612
 Existing PM

Level Of Service Computation Report
 2000 HCM Operations (Future Volume Alternative)
 Existing PP PM

Intersection #1: Wolfe Road / El Camino Real

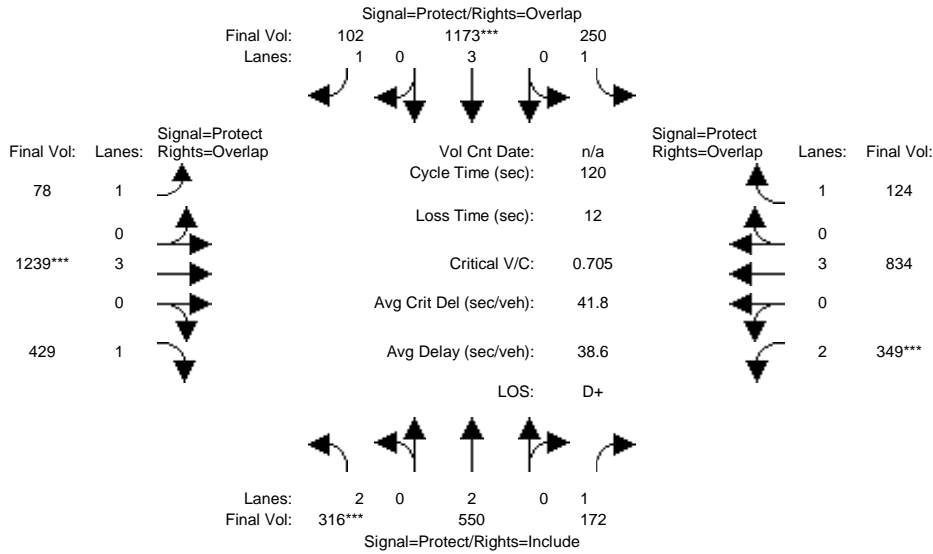

Street Name:	Wolfe Road						El Camino Real					
	North Bound			South Bound			East Bound			West Bound		
Approach:												
Movement:	L	T	R	L	T	R	L	T	R	L	T	R
Min. Green:	7	10	10	7	10	10	7	10	10	7	10	10
Y+R:	4.0	4.0	4.0	4.0	4.0	4.0	4.0	4.0	4.0	4.0	4.0	4.0

Volume Module:												
Base Vol:	307	545	170	250	1165	102	78	1239	413	346	834	124
Growth Adj:	1.00	1.00	1.00	1.00	1.00	1.00	1.00	1.00	1.00	1.00	1.00	1.00
Initial Bse:	307	545	170	250	1165	102	78	1239	413	346	834	124
Added Vol:	9	5	2	0	8	0	0	0	16	3	0	0
PasserByVol:	0	0	0	0	0	0	0	0	0	0	0	0
Initial Fut:	316	550	172	250	1173	102	78	1239	429	349	834	124
User Adj:	1.00	1.00	1.00	1.00	1.00	1.00	1.00	1.00	1.00	1.00	1.00	1.00
PHF Adj:	1.00	1.00	1.00	1.00	1.00	1.00	1.00	1.00	1.00	1.00	1.00	1.00
PHF Volume:	316	550	172	250	1173	102	78	1239	429	349	834	124
Reduct Vol:	0	0	0	0	0	0	0	0	0	0	0	0
Reduced Vol:	316	550	172	250	1173	102	78	1239	429	349	834	124
PCE Adj:	1.00	1.00	1.00	1.00	1.00	1.00	1.00	1.00	1.00	1.00	1.00	1.00
MLF Adj:	1.00	1.00	1.00	1.00	1.00	1.00	1.00	1.00	1.00	1.00	1.00	1.00
Final Volume:	316	550	172	250	1173	102	78	1239	429	349	834	124

Saturation Flow Module:												
Sat/Lane:	1900	1900	1900	1900	1900	1900	1900	1900	1900	1900	1900	1900
Adjustment:	0.83	1.00	0.92	0.92	1.00	0.92	0.92	1.00	0.92	0.83	1.00	0.92
Lanes:	2.00	2.00	1.00	1.00	3.00	1.00	1.00	3.00	1.00	2.00	3.00	1.00
Final Sat.:	3150	3800	1750	1750	5700	1750	1750	5700	1750	3150	5700	1750

Capacity Analysis Module:												
Vol/Sat:	0.10	0.14	0.10	0.14	0.21	0.06	0.04	0.22	0.25	0.11	0.15	0.07
Crit Moves:	***			****			****			****		
Green Time:	17.1	26.2	26.2	25.9	35.0	51.0	15.9	37.0	54.1	18.9	40.0	65.8
Volume/Cap:	0.70	0.66	0.45	0.66	0.70	0.14	0.34	0.70	0.54	0.70	0.44	0.13
Delay/Veh:	54.1	44.8	41.5	47.4	39.3	21.2	48.1	38.0	24.8	52.5	31.4	13.2
User DelAdj:	1.00	1.00	1.00	1.00	1.00	1.00	1.00	1.00	1.00	1.00	1.00	1.00
AdjDel/Veh:	54.1	44.8	41.5	47.4	39.3	21.2	48.1	38.0	24.8	52.5	31.4	13.2
LOS by Move:	D-	D	D	D	D	C+	D	D+	C	D-	C	B
HCM2kAvgQ:	7	9	6	10	14	2	3	14	12	9	8	2

Note: Queue reported is the number of cars per lane.

Hamptons Apartments Complex TIA
 SJ15-1612
 Existing PM

Level Of Service Computation Report
 2000 HCM Operations (Future Volume Alternative)
 Existing PM

Intersection #2: Wolfe Road / Fremont Avenue

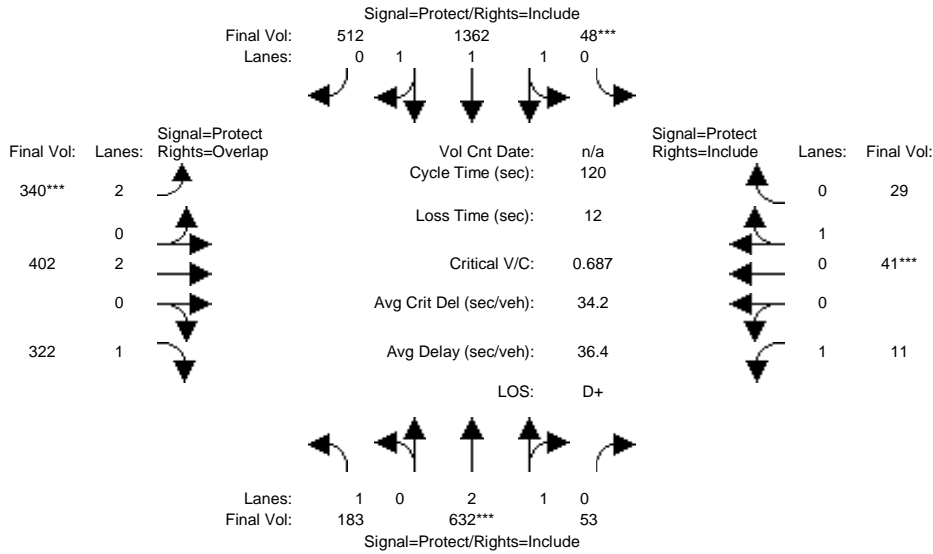

Street Name:	Wolfe Road						Fremont Avenue					
	North Bound			South Bound			East Bound			West Bound		
Approach:	L	T	R	L	T	R	L	T	R	L	T	R
Min. Green:	7	10	10	7	10	10	7	10	10	7	10	10
Y+R:	4.0	4.0	4.0	4.0	4.0	4.0	4.0	4.0	4.0	4.0	4.0	4.0

Volume Module:												
Base Vol:	183	632	53	48	1362	512	340	402	322	11	41	29
Growth Adj:	1.00	1.00	1.00	1.00	1.00	1.00	1.00	1.00	1.00	1.00	1.00	1.00
Initial Bse:	183	632	53	48	1362	512	340	402	322	11	41	29
Added Vol:	0	0	0	0	0	0	0	0	0	0	0	0
PasserByVol:	0	0	0	0	0	0	0	0	0	0	0	0
Initial Fut:	183	632	53	48	1362	512	340	402	322	11	41	29
User Adj:	1.00	1.00	1.00	1.00	1.00	1.00	1.00	1.00	1.00	1.00	1.00	1.00
PHF Adj:	1.00	1.00	1.00	1.00	1.00	1.00	1.00	1.00	1.00	1.00	1.00	1.00
PHF Volume:	183	632	53	48	1362	512	340	402	322	11	41	29
Reduct Vol:	0	0	0	0	0	0	0	0	0	0	0	0
Reduced Vol:	183	632	53	48	1362	512	340	402	322	11	41	29
PCE Adj:	1.00	1.00	1.00	1.00	1.00	1.00	1.00	1.00	1.00	1.00	1.00	1.00
MLF Adj:	1.00	1.00	1.00	1.00	1.00	1.00	1.00	1.00	1.00	1.00	1.00	1.00
Final Volume:	183	632	53	48	1362	512	340	402	322	11	41	29

Saturation Flow Module:												
Sat/Lane:	1900	1900	1900	1900	1900	1900	1900	1900	1900	1900	1900	1900
Adjustment:	0.92	0.99	0.95	0.95	0.97	0.95	0.83	1.00	0.92	0.92	0.95	0.95
Lanes:	1.00	2.76	0.24	0.08	2.11	0.81	2.00	2.00	1.00	1.00	0.59	0.41
Final Sat.:	1750	5166	433	137	3897	1465	3150	3800	1750	1750	1054	746

Capacity Analysis Module:												
Vol/Sat:	0.10	0.12	0.12	0.35	0.35	0.35	0.11	0.11	0.18	0.01	0.04	0.04
Crit Moves:	****			****			****			****		
Green Time:	18.4	20.7	20.7	59.1	61.4	61.4	18.2	18.2	36.6	10.0	10.0	10.0
Volume/Cap:	0.68	0.71	0.71	0.71	0.68	0.68	0.71	0.70	0.60	0.08	0.47	0.47
Delay/Veh:	55.1	49.3	49.3	24.7	22.7	22.7	53.3	52.0	37.5	50.9	54.7	54.7
User DelAdj:	1.00	1.00	1.00	1.00	1.00	1.00	1.00	1.00	1.00	1.00	1.00	1.00
AdjDel/Veh:	55.1	49.3	49.3	24.7	22.7	22.7	53.3	52.0	37.5	50.9	54.7	54.7
LOS by Move:	E+	D	D	C	C+	C+	D-	D-	D+	D	D-	D-
HCM2kAvgQ:	7	8	8	18	18	18	9	8	11	0	3	3

Note: Queue reported is the number of cars per lane.

Hamptons Apartments Complex TIA
 SJ15-1612
 Existing PM

Level Of Service Computation Report
 2000 HCM Operations (Future Volume Alternative)
 Existing PP PM

Intersection #2: Wolfe Road / Fremont Avenue

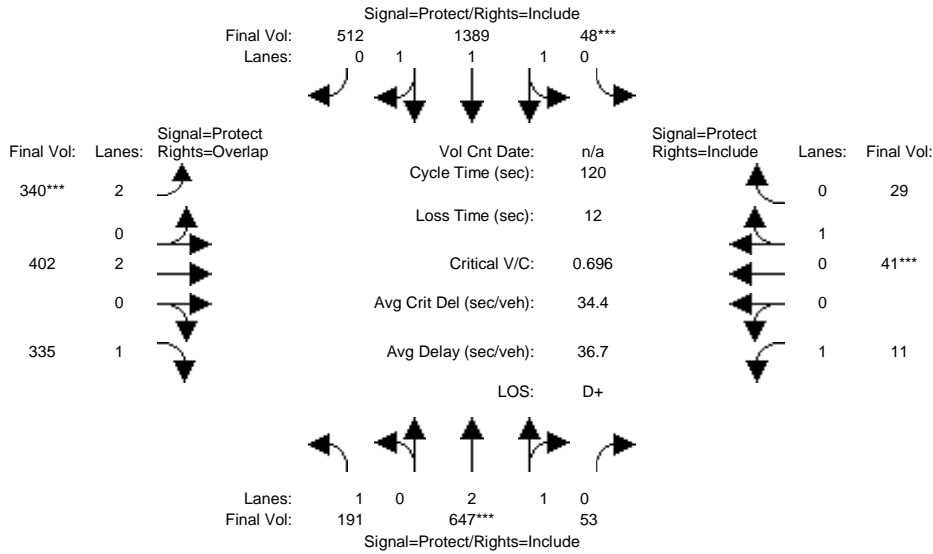

Street Name:	Wolfe Road						Fremont Avenue					
	North Bound			South Bound			East Bound			West Bound		
Approach:	L	T	R	L	T	R	L	T	R	L	T	R
Min. Green:	7	10	10	7	10	10	7	10	10	7	10	10
Y+R:	4.0	4.0	4.0	4.0	4.0	4.0	4.0	4.0	4.0	4.0	4.0	4.0

Volume Module:												
Base Vol:	183	632	53	48	1362	512	340	402	322	11	41	29
Growth Adj:	1.00	1.00	1.00	1.00	1.00	1.00	1.00	1.00	1.00	1.00	1.00	1.00
Initial Bse:	183	632	53	48	1362	512	340	402	322	11	41	29
Added Vol:	8	15	0	0	27	0	0	0	13	0	0	0
PasserByVol:	0	0	0	0	0	0	0	0	0	0	0	0
Initial Fut:	191	647	53	48	1389	512	340	402	335	11	41	29
User Adj:	1.00	1.00	1.00	1.00	1.00	1.00	1.00	1.00	1.00	1.00	1.00	1.00
PHF Adj:	1.00	1.00	1.00	1.00	1.00	1.00	1.00	1.00	1.00	1.00	1.00	1.00
PHF Volume:	191	647	53	48	1389	512	340	402	335	11	41	29
Reduct Vol:	0	0	0	0	0	0	0	0	0	0	0	0
Reduced Vol:	191	647	53	48	1389	512	340	402	335	11	41	29
PCE Adj:	1.00	1.00	1.00	1.00	1.00	1.00	1.00	1.00	1.00	1.00	1.00	1.00
MLF Adj:	1.00	1.00	1.00	1.00	1.00	1.00	1.00	1.00	1.00	1.00	1.00	1.00
Final Volume:	191	647	53	48	1389	512	340	402	335	11	41	29

Saturation Flow Module:												
Sat/Lane:	1900	1900	1900	1900	1900	1900	1900	1900	1900	1900	1900	1900
Adjustment:	0.92	0.99	0.95	0.95	0.97	0.95	0.83	1.00	0.92	0.92	0.95	0.95
Lanes:	1.00	2.76	0.24	0.08	2.12	0.80	2.00	2.00	1.00	1.00	0.59	0.41
Final Sat.:	1750	5175	424	135	3919	1445	3150	3800	1750	1750	1054	746

Capacity Analysis Module:												
Vol/Sat:	0.11	0.13	0.13	0.35	0.35	0.35	0.11	0.11	0.19	0.01	0.04	0.04
Crit Moves:	****			****			****			****		
Green Time:	18.8	20.9	20.9	59.1	61.2	61.2	18.0	18.1	36.9	10.0	10.0	10.0
Volume/Cap:	0.70	0.72	0.72	0.72	0.70	0.70	0.72	0.70	0.62	0.08	0.47	0.47
Delay/Veh:	55.4	49.4	49.4	24.9	23.1	23.1	53.9	52.4	37.9	51.0	54.7	54.7
User DelAdj:	1.00	1.00	1.00	1.00	1.00	1.00	1.00	1.00	1.00	1.00	1.00	1.00
AdjDel/Veh:	55.4	49.4	49.4	24.9	23.1	23.1	53.9	52.4	37.9	51.0	54.7	54.7
LOS by Move:	E+	D	D	C	C	C	D-	D-	D+	D-	D-	D-
HCM2kAvgQ:	7	8	8	19	18	18	9	8	12	0	3	3

Note: Queue reported is the number of cars per lane.

Hamptons Apartments Complex TIA
 SJ15-1612
 Existing PM

Level Of Service Computation Report
 2000 HCM Operations (Future Volume Alternative)
 Existing PM

Intersection #3: Wolfe Road / Marion Way

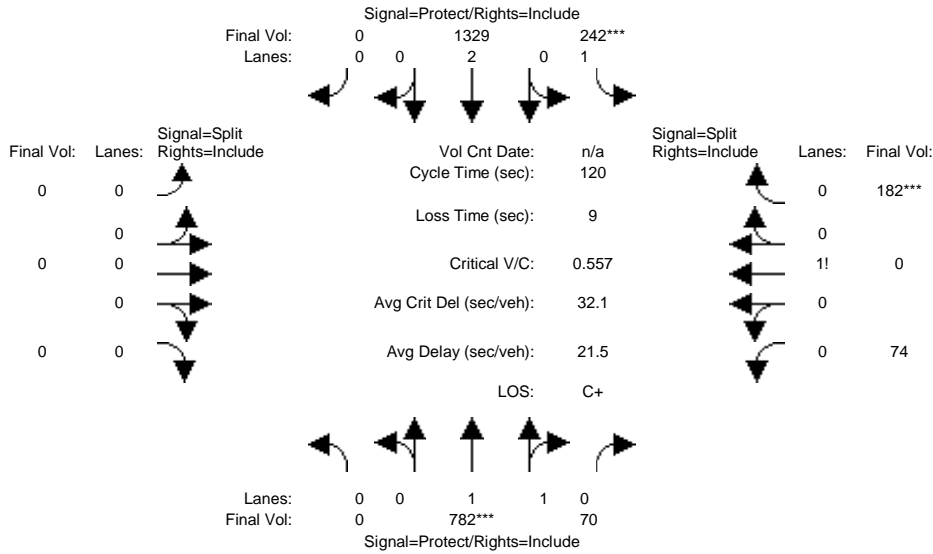

Street Name:	Wolfe Road						Marion Way					
	North Bound			South Bound			East Bound			West Bound		
Approach:	North Bound			South Bound			East Bound			West Bound		
Movement:	L	T	R	L	T	R	L	T	R	L	T	R
Min. Green:	7	10	10	7	10	10	0	0	0	10	10	10
Y+R:	4.0	4.0	4.0	4.0	4.0	4.0	4.0	4.0	4.0	4.0	4.0	4.0

Volume Module:												
Base Vol:	0	782	70	242	1329	0	0	0	0	74	0	182
Growth Adj:	1.00	1.00	1.00	1.00	1.00	1.00	1.00	1.00	1.00	1.00	1.00	1.00
Initial Bse:	0	782	70	242	1329	0	0	0	0	74	0	182
Added Vol:	0	0	0	0	0	0	0	0	0	0	0	0
PasserByVol:	0	0	0	0	0	0	0	0	0	0	0	0
Initial Fut:	0	782	70	242	1329	0	0	0	0	74	0	182
User Adj:	1.00	1.00	1.00	1.00	1.00	1.00	1.00	1.00	1.00	1.00	1.00	1.00
PHF Adj:	1.00	1.00	1.00	1.00	1.00	1.00	1.00	1.00	1.00	1.00	1.00	1.00
PHF Volume:	0	782	70	242	1329	0	0	0	0	74	0	182
Reduct Vol:	0	0	0	0	0	0	0	0	0	0	0	0
Reduced Vol:	0	782	70	242	1329	0	0	0	0	74	0	182
PCE Adj:	1.00	1.00	1.00	1.00	1.00	1.00	1.00	1.00	1.00	1.00	1.00	1.00
MLF Adj:	1.00	1.00	1.00	1.00	1.00	1.00	1.00	1.00	1.00	1.00	1.00	1.00
Final Volume:	0	782	70	242	1329	0	0	0	0	74	0	182

Saturation Flow Module:												
Sat/Lane:	1900	1900	1900	1900	1900	1900	1900	1900	1900	1900	1900	1900
Adjustment:	0.92	0.98	0.95	0.92	1.00	0.92	0.92	1.00	0.92	0.92	0.92	0.92
Lanes:	0.00	1.83	0.17	1.00	2.00	0.00	0.00	0.00	0.00	0.29	0.00	0.71
Final Sat.:	0	3396	304	1750	3800	0	0	0	0	506	0	1244

Capacity Analysis Module:												
Vol/Sat:	0.00	0.23	0.23	0.14	0.35	0.00	0.00	0.00	0.00	0.15	0.00	0.15
Crit Moves:	****			****						****		
Green Time:	0.0	49.6	49.6	29.8	79.5	0.0	0.0	0.0	0.0	31.5	0.0	31.5
Volume/Cap:	0.00	0.56	0.56	0.56	0.53	0.00	0.00	0.00	0.00	0.56	0.00	0.56
Delay/Veh:	0.0	27.2	27.2	40.9	10.7	0.0	0.0	0.0	0.0	39.7	0.0	39.7
User DelAdj:	1.00	1.00	1.00	1.00	1.00	1.00	1.00	1.00	1.00	1.00	1.00	1.00
AdjDel/Veh:	0.0	27.2	27.2	40.9	10.7	0.0	0.0	0.0	0.0	39.7	0.0	39.7
LOS by Move:	A	C	C	D	B+	A	A	A	A	D	A	D
HCM2kAvgQ:	0	12	12	8	12	0	0	0	0	9	0	9

Note: Queue reported is the number of cars per lane.

Hamptons Apartments Complex TIA
 SJ15-1612
 Existing PM

Level Of Service Computation Report
 2000 HCM Operations (Future Volume Alternative)
 Existing PP PM

Intersection #3: Wolfe Road / Marion Way

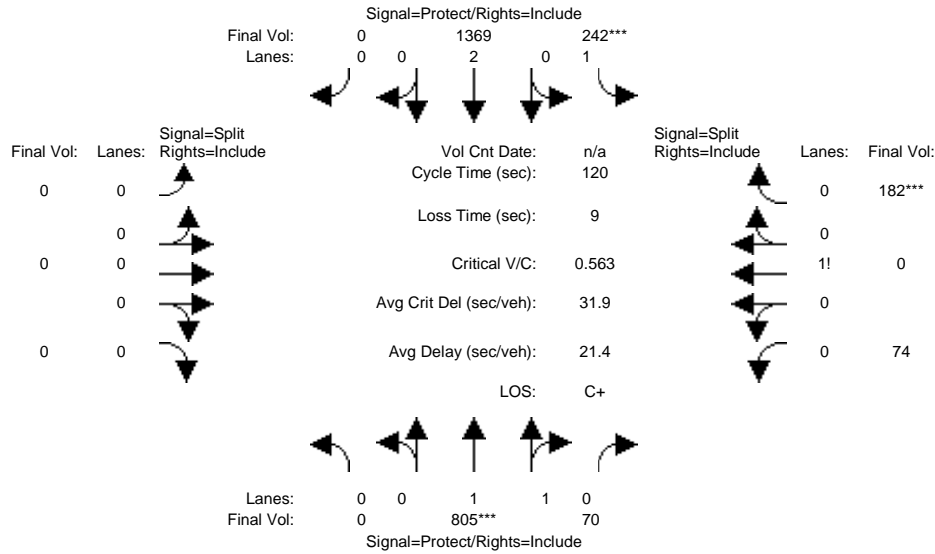

Street Name:	Wolfe Road						Marion Way					
	North Bound			South Bound			East Bound			West Bound		
Approach:	North Bound			South Bound			East Bound			West Bound		
Movement:	L	T	R	L	T	R	L	T	R	L	T	R
Min. Green:	7	10	10	7	10	10	0	0	0	10	10	10
Y+R:	4.0	4.0	4.0	4.0	4.0	4.0	4.0	4.0	4.0	4.0	4.0	4.0

Volume Module:												
Base Vol:	0	782	70	242	1329	0	0	0	0	74	0	182
Growth Adj:	1.00	1.00	1.00	1.00	1.00	1.00	1.00	1.00	1.00	1.00	1.00	1.00
Initial Bse:	0	782	70	242	1329	0	0	0	0	74	0	182
Added Vol:	0	23	0	0	40	0	0	0	0	0	0	0
PasserByVol:	0	0	0	0	0	0	0	0	0	0	0	0
Initial Fut:	0	805	70	242	1369	0	0	0	0	74	0	182
User Adj:	1.00	1.00	1.00	1.00	1.00	1.00	1.00	1.00	1.00	1.00	1.00	1.00
PHF Adj:	1.00	1.00	1.00	1.00	1.00	1.00	1.00	1.00	1.00	1.00	1.00	1.00
PHF Volume:	0	805	70	242	1369	0	0	0	0	74	0	182
Reduct Vol:	0	0	0	0	0	0	0	0	0	0	0	0
Reduced Vol:	0	805	70	242	1369	0	0	0	0	74	0	182
PCE Adj:	1.00	1.00	1.00	1.00	1.00	1.00	1.00	1.00	1.00	1.00	1.00	1.00
MLF Adj:	1.00	1.00	1.00	1.00	1.00	1.00	1.00	1.00	1.00	1.00	1.00	1.00
Final Volume:	0	805	70	242	1369	0	0	0	0	74	0	182

Saturation Flow Module:												
Sat/Lane:	1900	1900	1900	1900	1900	1900	1900	1900	1900	1900	1900	1900
Adjustment:	0.92	0.98	0.95	0.92	1.00	0.92	0.92	1.00	0.92	0.92	0.92	0.92
Lanes:	0.00	1.84	0.16	1.00	2.00	0.00	0.00	0.00	0.00	0.29	0.00	0.71
Final Sat.:	0	3404	296	1750	3800	0	0	0	0	506	0	1244

Capacity Analysis Module:												
Vol/Sat:	0.00	0.24	0.24	0.14	0.36	0.00	0.00	0.00	0.00	0.15	0.00	0.15
Crit Moves:	****			****						****		
Green Time:	0.0	50.4	50.4	29.5	79.8	0.0	0.0	0.0	0.0	31.2	0.0	31.2
Volume/Cap:	0.00	0.56	0.56	0.56	0.54	0.00	0.00	0.00	0.00	0.56	0.00	0.56
Delay/Veh:	0.0	26.9	26.9	41.4	10.7	0.0	0.0	0.0	0.0	40.1	0.0	40.1
User DelAdj:	1.00	1.00	1.00	1.00	1.00	1.00	1.00	1.00	1.00	1.00	1.00	1.00
AdjDel/Veh:	0.0	26.9	26.9	41.4	10.7	0.0	0.0	0.0	0.0	40.1	0.0	40.1
LOS by Move:	A	C	C	D	B+	A	A	A	A	D	A	D
HCM2kAvgQ:	0	12	12	8	13	0	0	0	0	9	0	9

Note: Queue reported is the number of cars per lane.

Hamptons Apartments Complex TIA
 SJ15-1612
 Existing PM

Level Of Service Computation Report
 2000 HCM Operations (Future Volume Alternative)
 Existing PM

Intersection #4: Wolfe Road / Inverness Avenue

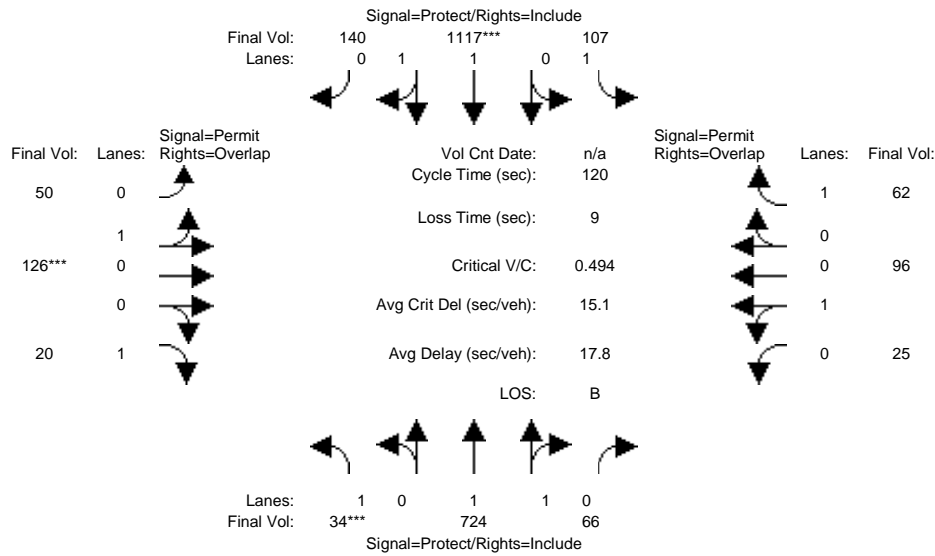

Street Name:	Wolfe Road						Inverness Avenue					
	North Bound			South Bound			East Bound			West Bound		
Approach:	North Bound			South Bound			East Bound			West Bound		
Movement:	L	T	R	L	T	R	L	T	R	L	T	R
Min. Green:	7	10	10	7	10	10	10	10	10	10	10	10
Y+R:	4.0	4.0	4.0	4.0	4.0	4.0	4.0	4.0	4.0	4.0	4.0	4.0

Volume Module:												
Base Vol:	34	724	66	107	1117	140	50	126	20	25	96	62
Growth Adj:	1.00	1.00	1.00	1.00	1.00	1.00	1.00	1.00	1.00	1.00	1.00	1.00
Initial Bse:	34	724	66	107	1117	140	50	126	20	25	96	62
Added Vol:	0	0	0	0	0	0	0	0	0	0	0	0
PasserByVol:	0	0	0	0	0	0	0	0	0	0	0	0
Initial Fut:	34	724	66	107	1117	140	50	126	20	25	96	62
User Adj:	1.00	1.00	1.00	1.00	1.00	1.00	1.00	1.00	1.00	1.00	1.00	1.00
PHF Adj:	1.00	1.00	1.00	1.00	1.00	1.00	1.00	1.00	1.00	1.00	1.00	1.00
PHF Volume:	34	724	66	107	1117	140	50	126	20	25	96	62
Reduct Vol:	0	0	0	0	0	0	0	0	0	0	0	0
Reduced Vol:	34	724	66	107	1117	140	50	126	20	25	96	62
PCE Adj:	1.00	1.00	1.00	1.00	1.00	1.00	1.00	1.00	1.00	1.00	1.00	1.00
MLF Adj:	1.00	1.00	1.00	1.00	1.00	1.00	1.00	1.00	1.00	1.00	1.00	1.00
Final Volume:	34	724	66	107	1117	140	50	126	20	25	96	62

Saturation Flow Module:												
Sat/Lane:	1900	1900	1900	1900	1900	1900	1900	1900	1900	1900	1900	1900
Adjustment:	0.92	0.98	0.95	0.92	0.98	0.95	0.95	0.95	0.92	0.95	0.95	0.92
Lanes:	1.00	1.83	0.17	1.00	1.77	0.23	0.28	0.72	1.00	0.21	0.79	1.00
Final Sat.:	1750	3391	309	1750	3288	412	511	1289	1750	372	1428	1750

Capacity Analysis Module:												
Vol/Sat:	0.02	0.21	0.21	0.06	0.34	0.34	0.10	0.10	0.01	0.07	0.07	0.04
Crit Moves:	***			***			***					
Green Time:	7.0	68.2	68.2	19.5	80.8	80.8	23.2	23.2	30.2	23.2	23.2	42.8
Volume/Cap:	0.33	0.38	0.38	0.38	0.50	0.50	0.50	0.50	0.05	0.35	0.35	0.10
Delay/Veh:	56.2	14.3	14.3	45.6	9.9	9.9	44.4	44.4	34.0	42.4	42.4	25.8
User DelAdj:	1.00	1.00	1.00	1.00	1.00	1.00	1.00	1.00	1.00	1.00	1.00	1.00
AdjDel/Veh:	56.2	14.3	14.3	45.6	9.9	9.9	44.4	44.4	34.0	42.4	42.4	25.8
LOS by Move:	E+	B	B	D	A	A	D	D	C-	D	D	C
HCM2kAvgQ:	1	8	8	4	11	11	7	7	1	4	4	2

Note: Queue reported is the number of cars per lane.

Hamptons Apartments Complex TIA
 SJ15-1612
 Existing PM

Level Of Service Computation Report
 2000 HCM Operations (Future Volume Alternative)
 Existing PP PM

Intersection #4: Wolfe Road / Inverness Avenue

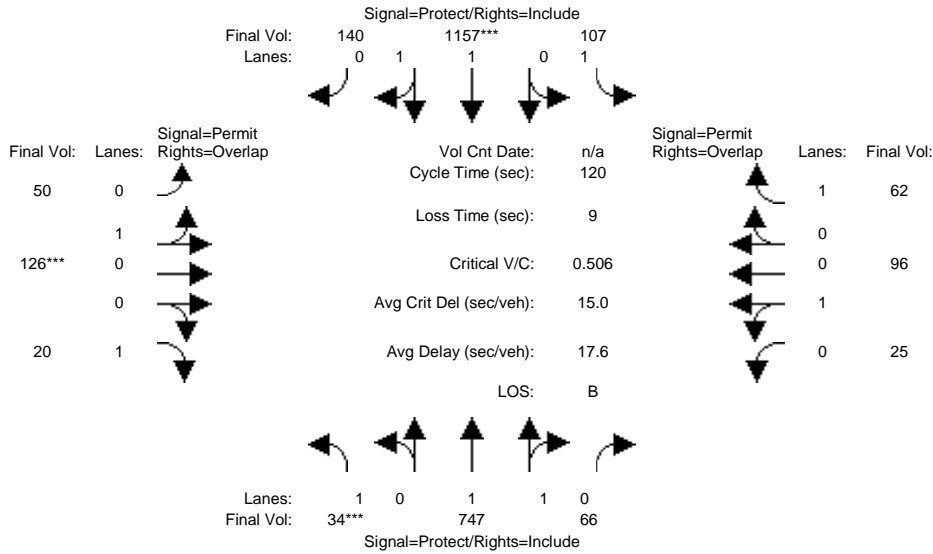

Street Name:	Wolfe Road						Inverness Avenue					
	North Bound			South Bound			East Bound			West Bound		
Approach:												
Movement:	L	T	R	L	T	R	L	T	R	L	T	R
Min. Green:	7	10	10	7	10	10	10	10	10	10	10	10
Y+R:	4.0	4.0	4.0	4.0	4.0	4.0	4.0	4.0	4.0	4.0	4.0	4.0

Volume Module:												
Base Vol:	34	724	66	107	1117	140	50	126	20	25	96	62
Growth Adj:	1.00	1.00	1.00	1.00	1.00	1.00	1.00	1.00	1.00	1.00	1.00	1.00
Initial Bse:	34	724	66	107	1117	140	50	126	20	25	96	62
Added Vol:	0	23	0	0	40	0	0	0	0	0	0	0
PasserByVol:	0	0	0	0	0	0	0	0	0	0	0	0
Initial Fut:	34	747	66	107	1157	140	50	126	20	25	96	62
User Adj:	1.00	1.00	1.00	1.00	1.00	1.00	1.00	1.00	1.00	1.00	1.00	1.00
PHF Adj:	1.00	1.00	1.00	1.00	1.00	1.00	1.00	1.00	1.00	1.00	1.00	1.00
PHF Volume:	34	747	66	107	1157	140	50	126	20	25	96	62
Reduct Vol:	0	0	0	0	0	0	0	0	0	0	0	0
Reduced Vol:	34	747	66	107	1157	140	50	126	20	25	96	62
PCE Adj:	1.00	1.00	1.00	1.00	1.00	1.00	1.00	1.00	1.00	1.00	1.00	1.00
MLF Adj:	1.00	1.00	1.00	1.00	1.00	1.00	1.00	1.00	1.00	1.00	1.00	1.00
Final Volume:	34	747	66	107	1157	140	50	126	20	25	96	62

Saturation Flow Module:												
Sat/Lane:	1900	1900	1900	1900	1900	1900	1900	1900	1900	1900	1900	1900
Adjustment:	0.92	0.98	0.95	0.92	0.98	0.95	0.95	0.95	0.92	0.95	0.95	0.92
Lanes:	1.00	1.83	0.17	1.00	1.78	0.22	0.28	0.72	1.00	0.21	0.79	1.00
Final Sat.:	1750	3399	300	1750	3300	399	511	1289	1750	372	1428	1750

Capacity Analysis Module:												
Vol/Sat:	0.02	0.22	0.22	0.06	0.35	0.35	0.10	0.10	0.01	0.07	0.07	0.04
Crit Moves:	***			***			***			***		
Green Time:	7.0	69.1	69.1	19.2	81.3	81.3	22.7	22.7	29.7	22.7	22.7	41.9
Volume/Cap:	0.33	0.38	0.38	0.38	0.52	0.52	0.52	0.52	0.05	0.36	0.36	0.10
Delay/Veh:	56.2	14.0	14.0	45.9	9.8	9.8	45.1	45.1	34.4	42.9	42.9	26.4
User DelAdj:	1.00	1.00	1.00	1.00	1.00	1.00	1.00	1.00	1.00	1.00	1.00	1.00
AdjDel/Veh:	56.2	14.0	14.0	45.9	9.8	9.8	45.1	45.1	34.4	42.9	42.9	26.4
LOS by Move:	E+	B	B	D	A	A	D	D	C-	D	D	C
HCM2kAvgQ:	1	8	8	4	12	12	7	7	1	4	4	2

Note: Queue reported is the number of cars per lane.

Hamptons Apartments Complex TIA
 SJ15-1612
 Existing PM

Level Of Service Computation Report
 2000 HCM Operations (Future Volume Alternative)
 Existing PM

Intersection #5: Wolfe Road / Homestead Road

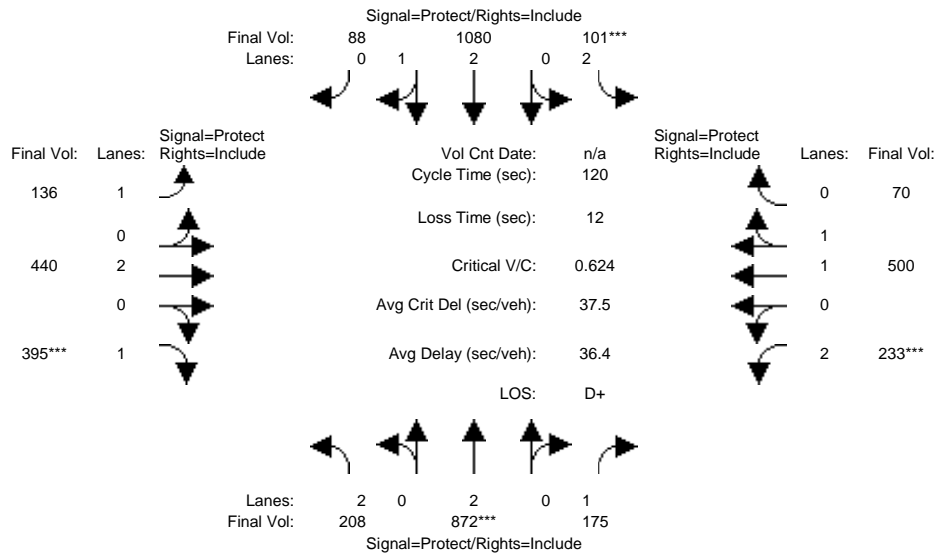

Street Name:	Wolfe Road						Homestead Road					
	North Bound			South Bound			East Bound			West Bound		
Approach:	L	T	R	L	T	R	L	T	R	L	T	R
Min. Green:	7	10	10	7	10	10	10	10	10	10	10	10
Y+R:	4.0	4.0	4.0	4.0	4.0	4.0	4.0	4.0	4.0	4.0	4.0	4.0

Volume Module:												
Base Vol:	208	872	175	101	1080	88	136	440	395	233	500	70
Growth Adj:	1.00	1.00	1.00	1.00	1.00	1.00	1.00	1.00	1.00	1.00	1.00	1.00
Initial Bse:	208	872	175	101	1080	88	136	440	395	233	500	70
Added Vol:	0	0	0	0	0	0	0	0	0	0	0	0
PasserByVol:	0	0	0	0	0	0	0	0	0	0	0	0
Initial Fut:	208	872	175	101	1080	88	136	440	395	233	500	70
User Adj:	1.00	1.00	1.00	1.00	1.00	1.00	1.00	1.00	1.00	1.00	1.00	1.00
PHF Adj:	1.00	1.00	1.00	1.00	1.00	1.00	1.00	1.00	1.00	1.00	1.00	1.00
PHF Volume:	208	872	175	101	1080	88	136	440	395	233	500	70
Reduct Vol:	0	0	0	0	0	0	0	0	0	0	0	0
Reduced Vol:	208	872	175	101	1080	88	136	440	395	233	500	70
PCE Adj:	1.00	1.00	1.00	1.00	1.00	1.00	1.00	1.00	1.00	1.00	1.00	1.00
MLF Adj:	1.00	1.00	1.00	1.00	1.00	1.00	1.00	1.00	1.00	1.00	1.00	1.00
Final Volume:	208	872	175	101	1080	88	136	440	395	233	500	70

Saturation Flow Module:												
Sat/Lane:	1900	1900	1900	1900	1900	1900	1900	1900	1900	1900	1900	1900
Adjustment:	0.83	1.00	0.92	0.83	0.99	0.95	0.92	1.00	0.92	0.83	0.98	0.95
Lanes:	2.00	2.00	1.00	2.00	2.77	0.23	1.00	2.00	1.00	2.00	1.75	0.25
Final Sat.:	3150	3800	1750	3150	5178	422	1750	3800	1750	3150	3245	454

Capacity Analysis Module:												
Vol/Sat:	0.07	0.23	0.10	0.03	0.21	0.21	0.08	0.12	0.23	0.07	0.15	0.15
Crit Moves:	****			****			****			****		
Green Time:	12.2	43.8	43.8	7.0	38.6	38.6	20.1	43.1	43.1	14.1	37.1	37.1
Volume/Cap:	0.65	0.63	0.27	0.55	0.65	0.65	0.46	0.32	0.63	0.63	0.50	0.50
Delay/Veh:	56.4	32.3	27.1	58.5	35.7	35.7	46.3	28.0	33.9	53.9	34.2	34.2
User DelAdj:	1.00	1.00	1.00	1.00	1.00	1.00	1.00	1.00	1.00	1.00	1.00	1.00
AdjDel/Veh:	56.4	32.3	27.1	58.5	35.7	35.7	46.3	28.0	33.9	53.9	34.2	34.2
LOS by Move:	E+	C-	C	E+	D+	D+	D	C	C-	D-	C-	C-
HCM2kAvgQ:	5	13	5	2	12	12	5	6	13	5	8	8

Note: Queue reported is the number of cars per lane.

Hamptons Apartments Complex TIA
 SJ15-1612
 Existing PM

Level Of Service Computation Report
 2000 HCM Operations (Future Volume Alternative)
 Existing PP PM

Intersection #5: Wolfe Road / Homestead Road

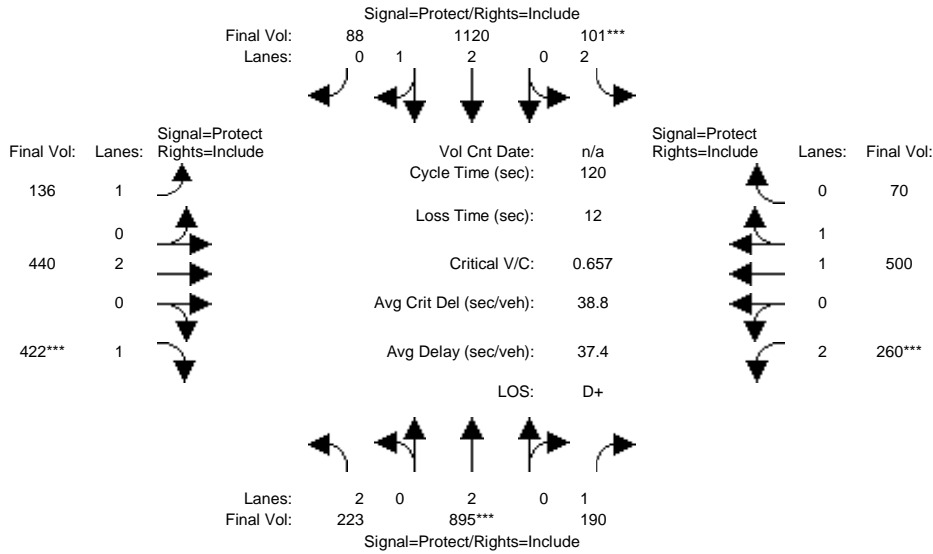

Street Name:	Wolfe Road						Homestead Road					
	North Bound			South Bound			East Bound			West Bound		
Approach:	North Bound			South Bound			East Bound			West Bound		
Movement:	L	T	R	L	T	R	L	T	R	L	T	R
Min. Green:	7	10	10	7	10	10	10	10	10	10	10	10
Y+R:	4.0	4.0	4.0	4.0	4.0	4.0	4.0	4.0	4.0	4.0	4.0	4.0

Volume Module:												
Base Vol:	208	872	175	101	1080	88	136	440	395	233	500	70
Growth Adj:	1.00	1.00	1.00	1.00	1.00	1.00	1.00	1.00	1.00	1.00	1.00	1.00
Initial Bse:	208	872	175	101	1080	88	136	440	395	233	500	70
Added Vol:	15	23	15	0	40	0	0	0	27	27	0	0
PasserByVol:	0	0	0	0	0	0	0	0	0	0	0	0
Initial Fut:	223	895	190	101	1120	88	136	440	422	260	500	70
User Adj:	1.00	1.00	1.00	1.00	1.00	1.00	1.00	1.00	1.00	1.00	1.00	1.00
PHF Adj:	1.00	1.00	1.00	1.00	1.00	1.00	1.00	1.00	1.00	1.00	1.00	1.00
PHF Volume:	223	895	190	101	1120	88	136	440	422	260	500	70
Reduct Vol:	0	0	0	0	0	0	0	0	0	0	0	0
Reduced Vol:	223	895	190	101	1120	88	136	440	422	260	500	70
PCE Adj:	1.00	1.00	1.00	1.00	1.00	1.00	1.00	1.00	1.00	1.00	1.00	1.00
MLF Adj:	1.00	1.00	1.00	1.00	1.00	1.00	1.00	1.00	1.00	1.00	1.00	1.00
Final Volume:	223	895	190	101	1120	88	136	440	422	260	500	70

Saturation Flow Module:												
Sat/Lane:	1900	1900	1900	1900	1900	1900	1900	1900	1900	1900	1900	1900
Adjustment:	0.83	1.00	0.92	0.83	0.99	0.95	0.92	1.00	0.92	0.83	0.98	0.95
Lanes:	2.00	2.00	1.00	2.00	2.77	0.23	1.00	2.00	1.00	2.00	1.75	0.25
Final Sat.:	3150	3800	1750	3150	5192	408	1750	3800	1750	3150	3245	454

Capacity Analysis Module:												
Vol/Sat:	0.07	0.24	0.11	0.03	0.22	0.22	0.08	0.12	0.24	0.08	0.15	0.15
Crit Moves:	****			****			****			****		
Green Time:	12.2	42.5	42.5	7.0	37.3	37.3	20.5	43.6	43.6	14.9	37.9	37.9
Volume/Cap:	0.69	0.66	0.31	0.55	0.69	0.69	0.45	0.32	0.66	0.66	0.49	0.49
Delay/Veh:	58.5	34.0	28.3	58.5	37.6	37.6	45.8	27.7	34.8	54.4	33.5	33.5
User DelAdj:	1.00	1.00	1.00	1.00	1.00	1.00	1.00	1.00	1.00	1.00	1.00	1.00
AdjDel/Veh:	58.5	34.0	28.3	58.5	37.6	37.6	45.8	27.7	34.8	54.4	33.5	33.5
LOS by Move:	E+	C-	C	E+	D+	D+	D	C	C-	D-	C-	C-
HCM2kAvgQ:	5	14	5	2	13	13	5	6	15	5	8	8

Note: Queue reported is the number of cars per lane.

Hamptons Apartments Complex TIA
 SJ15-1612
 Existing PM

Level Of Service Computation Report
 2000 HCM Operations (Future Volume Alternative)
 Existing PM

Intersection #6: Wolfe Road / Apple Campus 2

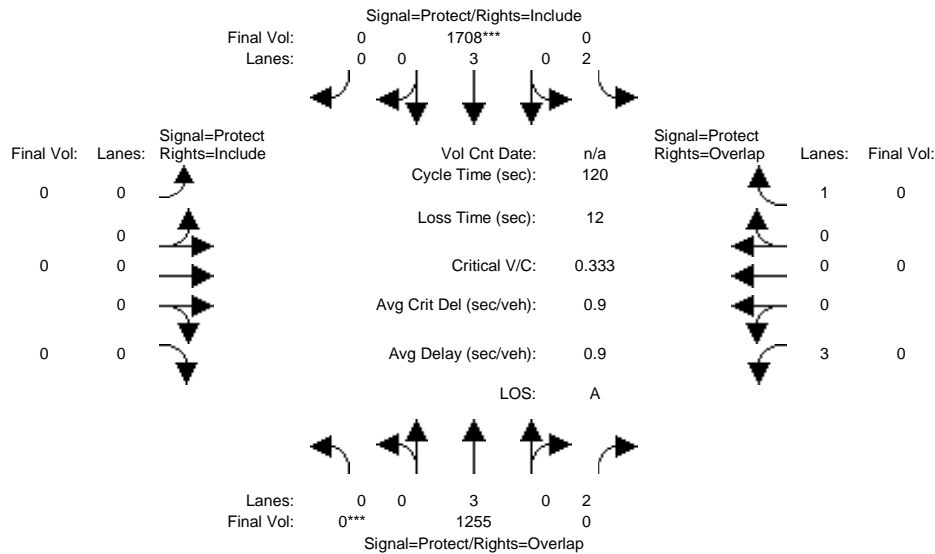

Street Name:	Wolfe Road						Apple Campus 2					
	North Bound			South Bound			East Bound			West Bound		
Approach:	North Bound			South Bound			East Bound			West Bound		
Movement:	L	T	R	L	T	R	L	T	R	L	T	R
Min. Green:	7	10	10	7	10	10	0	0	0	7	10	10
Y+R:	4.0	4.0	4.0	4.0	4.0	4.0	4.0	4.0	4.0	4.0	4.0	4.0

Volume Module:												
Base Vol:	0	1255	0	0	1708	0	0	0	0	0	0	0
Growth Adj:	1.00	1.00	1.00	1.00	1.00	1.00	1.00	1.00	1.00	1.00	1.00	1.00
Initial Bse:	0	1255	0	0	1708	0	0	0	0	0	0	0
Added Vol:	0	0	0	0	0	0	0	0	0	0	0	0
PasserByVol:	0	0	0	0	0	0	0	0	0	0	0	0
Initial Fut:	0	1255	0	0	1708	0	0	0	0	0	0	0
User Adj:	1.00	1.00	1.00	1.00	1.00	1.00	1.00	1.00	1.00	1.00	1.00	1.00
PHF Adj:	1.00	1.00	1.00	1.00	1.00	1.00	1.00	1.00	1.00	1.00	1.00	1.00
PHF Volume:	0	1255	0	0	1708	0	0	0	0	0	0	0
Reduct Vol:	0	0	0	0	0	0	0	0	0	0	0	0
Reduced Vol:	0	1255	0	0	1708	0	0	0	0	0	0	0
PCE Adj:	1.00	1.00	1.00	1.00	1.00	1.00	1.00	1.00	1.00	1.00	1.00	1.00
MLF Adj:	1.00	1.00	1.00	1.00	1.00	1.00	1.00	1.00	1.00	1.00	1.00	1.00
Final Volume:	0	1255	0	0	1708	0	0	0	0	0	0	0

Saturation Flow Module:												
Sat/Lane:	1900	1900	1900	1900	1900	1900	1900	1900	1900	1900	1900	1900
Adjustment:	0.92	1.00	0.83	0.83	1.00	0.92	0.92	1.00	0.92	0.80	1.00	0.92
Lanes:	0.00	3.00	2.00	2.00	3.00	0.00	0.00	0.00	0.00	3.00	0.00	1.00
Final Sat.:	0	5700	3150	3150	5700	0	0	0	0	4551	0	1750

Capacity Analysis Module:												
Vol/Sat:	0.00	0.22	0.00	0.00	0.30	0.00	0.00	0.00	0.00	0.00	0.00	0.00
Crit Moves:	***			****								
Green Time:	0.0	108	0.0	0.0	108	0.0	0.0	0.0	0.0	0.0	0.0	0.0
Volume/Cap:	0.00	0.24	0.00	0.00	0.33	0.00	0.00	0.00	0.00	0.00	0.00	0.00
Delay/Veh:	0.0	0.8	0.0	0.0	0.9	0.0	0.0	0.0	0.0	0.0	0.0	0.0
User DelAdj:	1.00	1.00	1.00	1.00	1.00	1.00	1.00	1.00	1.00	1.00	1.00	1.00
AdjDel/Veh:	0.0	0.8	0.0	0.0	0.9	0.0	0.0	0.0	0.0	0.0	0.0	0.0
LOS by Move:	A	A	A	A	A	A	A	A	A	A	A	A
HCM2kAvgQ:	0	2	0	0	3	0	0	0	0	0	0	0

Note: Queue reported is the number of cars per lane.

Hamptons Apartments Complex TIA
 SJ15-1612
 Existing PM

Level Of Service Computation Report
 2000 HCM Operations (Future Volume Alternative)
 Existing PP PM

Intersection #6: Wolfe Road / Apple Campus 2

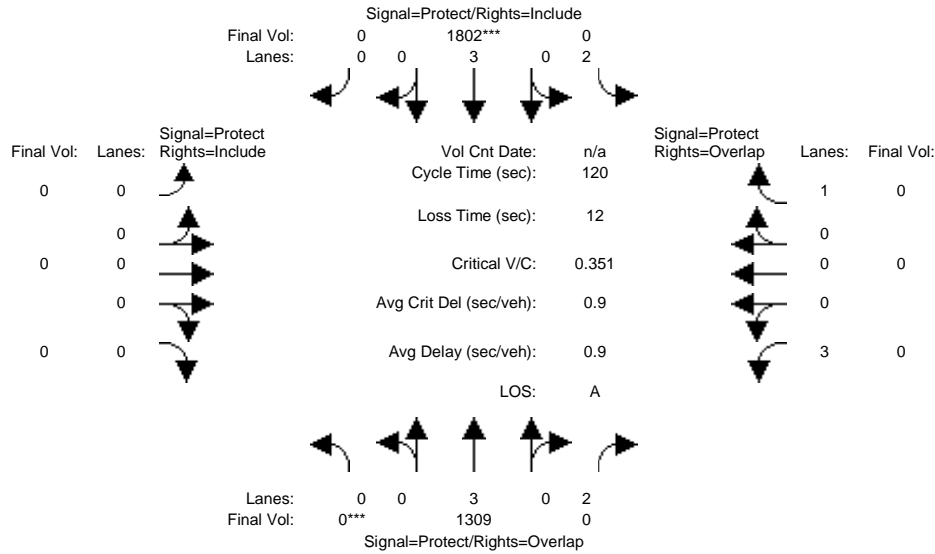

Street Name:	Wolfe Road						Apple Campus 2					
	North Bound			South Bound			East Bound			West Bound		
Approach:	North Bound			South Bound			East Bound			West Bound		
Movement:	L	T	R	L	T	R	L	T	R	L	T	R
Min. Green:	7	10	10	7	10	10	0	0	0	7	10	10
Y+R:	4.0	4.0	4.0	4.0	4.0	4.0	4.0	4.0	4.0	4.0	4.0	4.0

Volume Module:												
Base Vol:	0	1255	0	0	1708	0	0	0	0	0	0	0
Growth Adj:	1.00	1.00	1.00	1.00	1.00	1.00	1.00	1.00	1.00	1.00	1.00	1.00
Initial Bse:	0	1255	0	0	1708	0	0	0	0	0	0	0
Added Vol:	0	54	0	0	94	0	0	0	0	0	0	0
PasserByVol:	0	0	0	0	0	0	0	0	0	0	0	0
Initial Fut:	0	1309	0	0	1802	0	0	0	0	0	0	0
User Adj:	1.00	1.00	1.00	1.00	1.00	1.00	1.00	1.00	1.00	1.00	1.00	1.00
PHF Adj:	1.00	1.00	1.00	1.00	1.00	1.00	1.00	1.00	1.00	1.00	1.00	1.00
PHF Volume:	0	1309	0	0	1802	0	0	0	0	0	0	0
Reduct Vol:	0	0	0	0	0	0	0	0	0	0	0	0
Reduced Vol:	0	1309	0	0	1802	0	0	0	0	0	0	0
PCE Adj:	1.00	1.00	1.00	1.00	1.00	1.00	1.00	1.00	1.00	1.00	1.00	1.00
MLF Adj:	1.00	1.00	1.00	1.00	1.00	1.00	1.00	1.00	1.00	1.00	1.00	1.00
Final Volume:	0	1309	0	0	1802	0	0	0	0	0	0	0

Saturation Flow Module:												
Sat/Lane:	1900	1900	1900	1900	1900	1900	1900	1900	1900	1900	1900	1900
Adjustment:	0.92	1.00	0.83	0.83	1.00	0.92	0.92	1.00	0.92	0.80	1.00	0.92
Lanes:	0.00	3.00	2.00	2.00	3.00	0.00	0.00	0.00	0.00	3.00	0.00	1.00
Final Sat.:	0	5700	3150	3150	5700	0	0	0	0	4551	0	1750

Capacity Analysis Module:												
Vol/Sat:	0.00	0.23	0.00	0.00	0.32	0.00	0.00	0.00	0.00	0.00	0.00	0.00
Crit Moves:	***			****								
Green Time:	0.0	108	0.0	0.0	108	0.0	0.0	0.0	0.0	0.0	0.0	0.0
Volume/Cap:	0.00	0.26	0.00	0.00	0.35	0.00	0.00	0.00	0.00	0.00	0.00	0.00
Delay/Veh:	0.0	0.8	0.0	0.0	0.9	0.0	0.0	0.0	0.0	0.0	0.0	0.0
User DelAdj:	1.00	1.00	1.00	1.00	1.00	1.00	1.00	1.00	1.00	1.00	1.00	1.00
AdjDel/Veh:	0.0	0.8	0.0	0.0	0.9	0.0	0.0	0.0	0.0	0.0	0.0	0.0
LOS by Move:	A	A	A	A	A	A	A	A	A	A	A	A
HCM2kAvgQ:	0	2	0	0	3	0	0	0	0	0	0	0

Note: Queue reported is the number of cars per lane.

Hamptons Apartments Complex TIA
 SJ15-1612
 Existing PM

Level Of Service Computation Report
 2000 HCM Operations (Future Volume Alternative)
 Existing PM

Intersection #7: Wolfe Road / Pruneridge Avenue

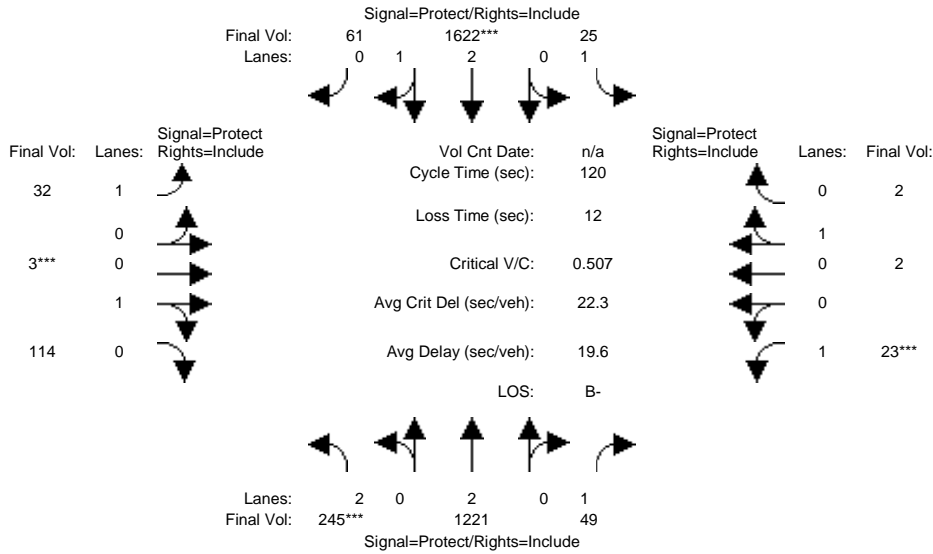

Street Name:	Wolfe Road						Pruneridge Avenue					
	North Bound			South Bound			East Bound			West Bound		
Approach:	L	T	R	L	T	R	L	T	R	L	T	R
Min. Green:	7	10	10	7	10	10	7	10	10	7	10	10
Y+R:	4.0	4.0	4.0	4.0	4.0	4.0	4.0	4.0	4.0	4.0	4.0	4.0

Volume Module:												
Base Vol:	245	1221	49	25	1622	61	32	3	114	23	2	2
Growth Adj:	1.00	1.00	1.00	1.00	1.00	1.00	1.00	1.00	1.00	1.00	1.00	1.00
Initial Bse:	245	1221	49	25	1622	61	32	3	114	23	2	2
Added Vol:	0	0	0	0	0	0	0	0	0	0	0	0
PasserByVol:	0	0	0	0	0	0	0	0	0	0	0	0
Initial Fut:	245	1221	49	25	1622	61	32	3	114	23	2	2
User Adj:	1.00	1.00	1.00	1.00	1.00	1.00	1.00	1.00	1.00	1.00	1.00	1.00
PHF Adj:	1.00	1.00	1.00	1.00	1.00	1.00	1.00	1.00	1.00	1.00	1.00	1.00
PHF Volume:	245	1221	49	25	1622	61	32	3	114	23	2	2
Reduct Vol:	0	0	0	0	0	0	0	0	0	0	0	0
Reduced Vol:	245	1221	49	25	1622	61	32	3	114	23	2	2
PCE Adj:	1.00	1.00	1.00	1.00	1.00	1.00	1.00	1.00	1.00	1.00	1.00	1.00
MLF Adj:	1.00	1.00	1.00	1.00	1.00	1.00	1.00	1.00	1.00	1.00	1.00	1.00
Final Volume:	245	1221	49	25	1622	61	32	3	114	23	2	2

Saturation Flow Module:												
Sat/Lane:	1900	1900	1900	1900	1900	1900	1900	1900	1900	1900	1900	1900
Adjustment:	0.83	1.00	0.92	0.92	0.98	0.95	0.92	0.95	0.95	0.92	0.95	0.95
Lanes:	2.00	2.00	1.00	1.00	2.89	0.11	1.00	0.03	0.97	1.00	0.50	0.50
Final Sat.:	3150	3800	1750	1750	5397	203	1750	46	1754	1750	900	900

Capacity Analysis Module:												
Vol/Sat:	0.08	0.32	0.03	0.01	0.30	0.30	0.02	0.07	0.07	0.01	0.00	0.00
Crit Moves:	***			****			****			****		
Green Time:	17.7	72.9	72.9	13.2	68.5	68.5	9.0	14.8	14.8	7.0	12.8	12.8
Volume/Cap:	0.53	0.53	0.05	0.13	0.53	0.53	0.24	0.53	0.53	0.23	0.02	0.02
Delay/Veh:	48.4	13.8	9.5	48.5	16.0	16.0	53.3	51.7	51.7	55.0	48.0	48.0
User DelAdj:	1.00	1.00	1.00	1.00	1.00	1.00	1.00	1.00	1.00	1.00	1.00	1.00
AdjDel/Veh:	48.4	13.8	9.5	48.5	16.0	16.0	53.3	51.7	51.7	55.0	48.0	48.0
LOS by Move:	D	B	A	D	B	B	D-	D-	D-	E+	D	D
HCM2kAvgQ:	5	13	1	1	13	13	1	5	5	1	0	0

Note: Queue reported is the number of cars per lane.

Hamptons Apartments Complex TIA
 SJ15-1612
 Existing PM

Level Of Service Computation Report
 2000 HCM Operations (Future Volume Alternative)
 Existing PP PM

Intersection #7: Wolfe Road / Pruneridge Avenue

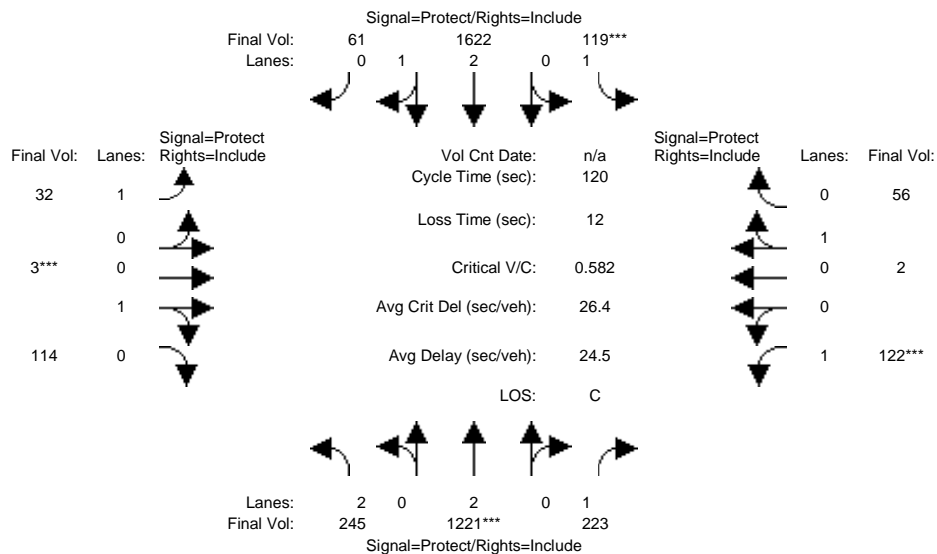

Street Name:	Wolfe Road						Pruneridge Avenue					
	North Bound			South Bound			East Bound			West Bound		
Approach:	L	T	R	L	T	R	L	T	R	L	T	R
Min. Green:	7	10	10	7	10	10	7	10	10	7	10	10
Y+R:	4.0	4.0	4.0	4.0	4.0	4.0	4.0	4.0	4.0	4.0	4.0	4.0

Volume Module:												
Base Vol:	245	1221	49	25	1622	61	32	3	114	23	2	2
Growth Adj:	1.00	1.00	1.00	1.00	1.00	1.00	1.00	1.00	1.00	1.00	1.00	1.00
Initial Bse:	245	1221	49	25	1622	61	32	3	114	23	2	2
Added Vol:	0	0	174	94	0	0	0	0	0	99	0	54
PasserByVol:	0	0	0	0	0	0	0	0	0	0	0	0
Initial Fut:	245	1221	223	119	1622	61	32	3	114	122	2	56
User Adj:	1.00	1.00	1.00	1.00	1.00	1.00	1.00	1.00	1.00	1.00	1.00	1.00
PHF Adj:	1.00	1.00	1.00	1.00	1.00	1.00	1.00	1.00	1.00	1.00	1.00	1.00
PHF Volume:	245	1221	223	119	1622	61	32	3	114	122	2	56
Reduct Vol:	0	0	0	0	0	0	0	0	0	0	0	0
Reduced Vol:	245	1221	223	119	1622	61	32	3	114	122	2	56
PCE Adj:	1.00	1.00	1.00	1.00	1.00	1.00	1.00	1.00	1.00	1.00	1.00	1.00
MLF Adj:	1.00	1.00	1.00	1.00	1.00	1.00	1.00	1.00	1.00	1.00	1.00	1.00
Final Volume:	245	1221	223	119	1622	61	32	3	114	122	2	56

Saturation Flow Module:												
Sat/Lane:	1900	1900	1900	1900	1900	1900	1900	1900	1900	1900	1900	1900
Adjustment:	0.83	1.00	0.92	0.92	0.98	0.95	0.92	0.95	0.95	0.92	0.95	0.95
Lanes:	2.00	2.00	1.00	1.00	2.89	0.11	1.00	0.03	0.97	1.00	0.03	0.97
Final Sat.:	3150	3800	1750	1750	5397	203	1750	46	1754	1750	62	1738

Capacity Analysis Module:												
Vol/Sat:	0.08	0.32	0.13	0.07	0.30	0.30	0.02	0.07	0.07	0.07	0.03	0.03
Crit Moves:	****			****			****			****		
Green Time:	16.5	66.2	66.2	14.0	63.7	63.7	11.4	13.4	13.4	14.4	16.3	16.3
Volume/Cap:	0.57	0.58	0.23	0.58	0.57	0.57	0.19	0.58	0.58	0.58	0.24	0.24
Delay/Veh:	50.2	18.2	13.9	54.4	19.1	19.1	50.6	54.9	54.9	54.1	46.8	46.8
User DelAdj:	1.00	1.00	1.00	1.00	1.00	1.00	1.00	1.00	1.00	1.00	1.00	1.00
AdjDel/Veh:	50.2	18.2	13.9	54.4	19.1	19.1	50.6	54.9	54.9	54.1	46.8	46.8
LOS by Move:	D	B-	B	D-	B-	B-	D	D-	D-	D-	D	D
HCM2kAvgQ:	5	14	4	5	14	14	1	5	5	5	2	2

Note: Queue reported is the number of cars per lane.

Hamptons Apartments Complex TIA
 SJ15-1612
 Existing PM

Level Of Service Computation Report
 2000 HCM Operations (Future Volume Alternative)
 Existing PM

Intersection #8: Wolfe Road / I-280 NB Ramps

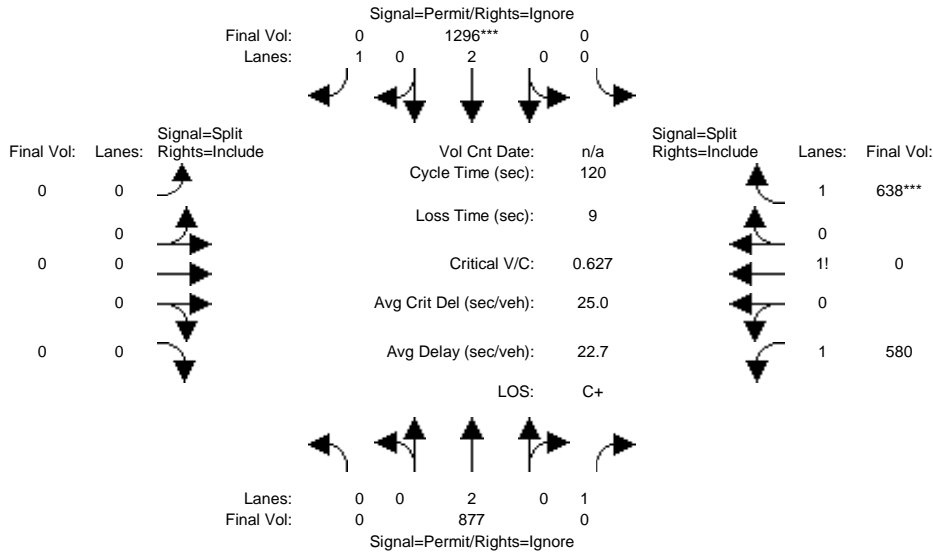

Street Name:	Wolfe Road						I-280 NB Ramps					
Approach:	North Bound			South Bound			East Bound			West Bound		
Movement:	L	T	R	L	T	R	L	T	R	L	T	R
Min. Green:	10	10	10	10	10	10	0	0	0	10	10	10
Y+R:	5.0	5.0	5.0	5.0	5.0	5.0	5.0	5.0	5.0	5.0	5.0	5.0
Volume Module:												
Base Vol:	0	877	465	0	1296	463	0	0	0	580	0	638
Growth Adj:	1.00	1.00	1.00	1.00	1.00	1.00	1.00	1.00	1.00	1.00	1.00	1.00
Initial Bse:	0	877	465	0	1296	463	0	0	0	580	0	638
Added Vol:	0	0	0	0	0	0	0	0	0	0	0	0
PasserByVol:	0	0	0	0	0	0	0	0	0	0	0	0
Initial Fut:	0	877	465	0	1296	463	0	0	0	580	0	638
User Adj:	1.00	1.00	0.00	1.00	1.00	0.00	1.00	1.00	1.00	1.00	1.00	1.00
PHF Adj:	1.00	1.00	0.00	1.00	1.00	0.00	1.00	1.00	1.00	1.00	1.00	1.00
PHF Volume:	0	877	0	0	1296	0	0	0	0	580	0	638
Reduct Vol:	0	0	0	0	0	0	0	0	0	0	0	0
Reduced Vol:	0	877	0	0	1296	0	0	0	0	580	0	638
PCE Adj:	1.00	1.00	0.00	1.00	1.00	0.00	1.00	1.00	1.00	1.00	1.00	1.00
MLF Adj:	1.00	1.00	0.00	1.00	1.00	0.00	1.00	1.00	1.00	1.00	1.00	1.00
Final Volume:	0	877	0	0	1296	0	0	0	0	580	0	638
Saturation Flow Module:												
Sat/Lane:	1900	1900	1900	1900	1900	1900	1900	1900	1900	1900	1900	1900
Adjustment:	0.92	1.00	0.92	0.92	1.00	0.92	0.92	1.00	0.92	0.92	1.00	0.92
Lanes:	0.00	2.00	1.00	0.00	2.00	1.00	0.00	0.00	0.00	1.48	0.00	1.52
Final Sat.:	0	3800	1750	0	3800	1750	0	0	0	2583	0	2667
Capacity Analysis Module:												
Vol/Sat:	0.00	0.23	0.00	0.00	0.34	0.00	0.00	0.00	0.00	0.22	0.00	0.24
Crit Moves:					****							****
Green Time:	0.0	65.2	0.0	0.0	65.2	0.0	0.0	0.0	0.0	45.8	0.0	45.8
Volume/Cap:	0.00	0.42	0.00	0.00	0.63	0.00	0.00	0.00	0.00	0.59	0.00	0.63
Delay/Veh:	0.0	16.4	0.0	0.0	19.6	0.0	0.0	0.0	0.0	30.1	0.0	30.8
User DelAdj:	1.00	1.00	1.00	1.00	1.00	1.00	1.00	1.00	1.00	1.00	1.00	1.00
AdjDel/Veh:	0.0	16.4	0.0	0.0	19.6	0.0	0.0	0.0	0.0	30.1	0.0	30.8
LOS by Move:	A	B	A	A	B-	A	A	A	A	C	A	C
HCM2kAvgQ:	0	3	0	0	6	0	0	0	0	13	0	14

Note: Queue reported is the number of cars per lane.

Hamptons Apartments Complex TIA
 SJ15-1612
 Existing PM

Level Of Service Computation Report
 2000 HCM Operations (Future Volume Alternative)
 Existing PP PM

Intersection #8: Wolfe Road / I-280 NB Ramps

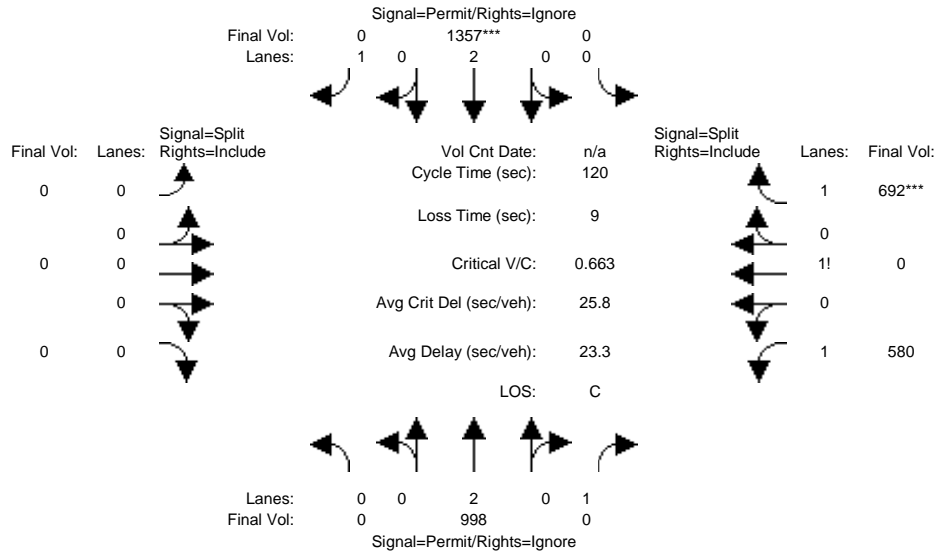

Street Name:	Wolfe Road						I-280 NB Ramps					
Approach:	North Bound			South Bound			East Bound			West Bound		
Movement:	L	T	R	L	T	R	L	T	R	L	T	R
Min. Green:	10	10	10	10	10	10	0	0	0	10	10	10
Y+R:	5.0	5.0	5.0	5.0	5.0	5.0	5.0	5.0	5.0	5.0	5.0	5.0
Volume Module:												
Base Vol:	0	877	465	0	1296	463	0	0	0	580	0	638
Growth Adj:	1.00	1.00	1.00	1.00	1.00	1.00	1.00	1.00	1.00	1.00	1.00	1.00
Initial Bse:	0	877	465	0	1296	463	0	0	0	580	0	638
Added Vol:	0	121	0	0	61	38	0	0	0	0	0	54
PasserByVol:	0	0	0	0	0	0	0	0	0	0	0	0
Initial Fut:	0	998	465	0	1357	501	0	0	0	580	0	692
User Adj:	1.00	1.00	0.00	1.00	1.00	0.00	1.00	1.00	1.00	1.00	1.00	1.00
PHF Adj:	1.00	1.00	0.00	1.00	1.00	0.00	1.00	1.00	1.00	1.00	1.00	1.00
PHF Volume:	0	998	0	0	1357	0	0	0	0	580	0	692
Reduct Vol:	0	0	0	0	0	0	0	0	0	0	0	0
Reduced Vol:	0	998	0	0	1357	0	0	0	0	580	0	692
PCE Adj:	1.00	1.00	0.00	1.00	1.00	0.00	1.00	1.00	1.00	1.00	1.00	1.00
MLF Adj:	1.00	1.00	0.00	1.00	1.00	0.00	1.00	1.00	1.00	1.00	1.00	1.00
Final Volume:	0	998	0	0	1357	0	0	0	0	580	0	692
Saturation Flow Module:												
Sat/Lane:	1900	1900	1900	1900	1900	1900	1900	1900	1900	1900	1900	1900
Adjustment:	0.92	1.00	0.92	0.92	1.00	0.92	0.92	1.00	0.92	0.92	1.00	0.92
Lanes:	0.00	2.00	1.00	0.00	2.00	1.00	0.00	0.00	0.00	1.46	0.00	1.54
Final Sat.:	0	3800	1750	0	3800	1750	0	0	0	2548	0	2702
Capacity Analysis Module:												
Vol/Sat:	0.00	0.26	0.00	0.00	0.36	0.00	0.00	0.00	0.00	0.23	0.00	0.26
Crit Moves:					****							****
Green Time:	0.0	64.6	0.0	0.0	64.6	0.0	0.0	0.0	0.0	46.4	0.0	46.4
Volume/Cap:	0.00	0.49	0.00	0.00	0.66	0.00	0.00	0.00	0.00	0.59	0.00	0.66
Delay/Veh:	0.0	17.5	0.0	0.0	20.7	0.0	0.0	0.0	0.0	29.7	0.0	31.3
User DelAdj:	1.00	1.00	1.00	1.00	1.00	1.00	1.00	1.00	1.00	1.00	1.00	1.00
AdjDel/Veh:	0.0	17.5	0.0	0.0	20.7	0.0	0.0	0.0	0.0	29.7	0.0	31.3
LOS by Move:	A	B	A	A	C+	A	A	A	A	C	A	C
HCM2kAvgQ:	0	4	0	0	7	0	0	0	0	13	0	15

Note: Queue reported is the number of cars per lane.

Hamptons Apartments Complex TIA
 SJ15-1612
 Existing PM

Level Of Service Computation Report
 2000 HCM Operations (Future Volume Alternative)
 Existing PM

Intersection #9: Wolfe Road / I-280 SB Ramps

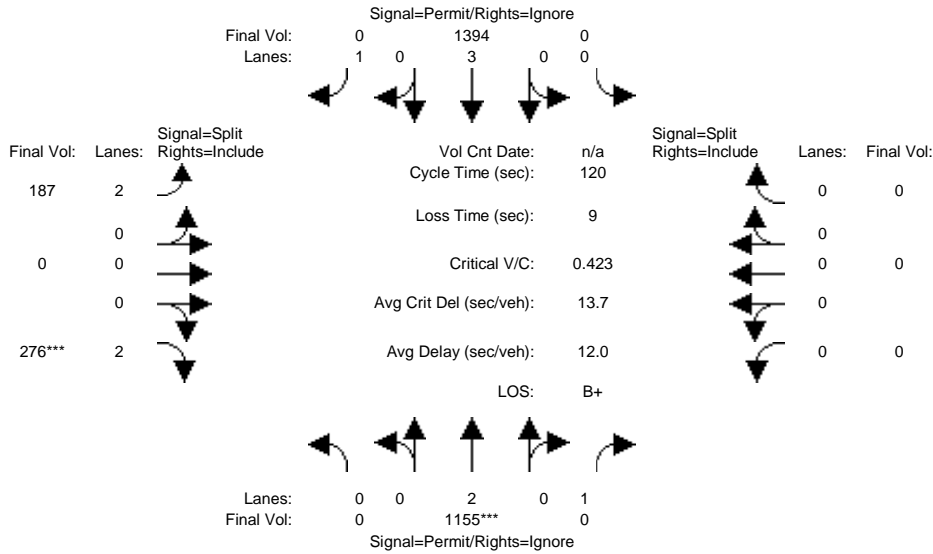

Street Name:	Wolfe Road						I-280 SB Ramps					
Approach:	North Bound			South Bound			East Bound			West Bound		
Movement:	L	T	R	L	T	R	L	T	R	L	T	R
Min. Green:	10	10	10	10	10	10	10	10	10	0	0	0
Y+R:	5.0	5.0	5.0	5.0	5.0	5.0	5.0	5.0	5.0	5.0	5.0	5.0
Volume Module:												
Base Vol:	0	1155	503	0	1394	482	187	0	276	0	0	0
Growth Adj:	1.00	1.00	1.00	1.00	1.00	1.00	1.00	1.00	1.00	1.00	1.00	1.00
Initial Bse:	0	1155	503	0	1394	482	187	0	276	0	0	0
Added Vol:	0	0	0	0	0	0	0	0	0	0	0	0
PasserByVol:	0	0	0	0	0	0	0	0	0	0	0	0
Initial Fut:	0	1155	503	0	1394	482	187	0	276	0	0	0
User Adj:	1.00	1.00	0.00	1.00	1.00	0.00	1.00	1.00	1.00	1.00	1.00	1.00
PHF Adj:	1.00	1.00	0.00	1.00	1.00	0.00	1.00	1.00	1.00	1.00	1.00	1.00
PHF Volume:	0	1155	0	0	1394	0	187	0	276	0	0	0
Reduct Vol:	0	0	0	0	0	0	0	0	0	0	0	0
Reduced Vol:	0	1155	0	0	1394	0	187	0	276	0	0	0
PCE Adj:	1.00	1.00	0.00	1.00	1.00	0.00	1.00	1.00	1.00	1.00	1.00	1.00
MLF Adj:	1.00	1.00	0.00	1.00	1.00	0.00	1.00	1.00	1.00	1.00	1.00	1.00
Final Volume:	0	1155	0	0	1394	0	187	0	276	0	0	0
Saturation Flow Module:												
Sat/Lane:	1900	1900	1900	1900	1900	1900	1900	1900	1900	1900	1900	1900
Adjustment:	0.92	1.00	0.92	0.92	1.00	0.92	0.83	1.00	0.83	0.92	1.00	0.92
Lanes:	0.00	2.00	1.00	0.00	3.00	1.00	2.00	0.00	2.00	0.00	0.00	0.00
Final Sat.:	0	3800	1750	0	5700	1750	3150	0	3150	0	0	0
Capacity Analysis Module:												
Vol/Sat:	0.00	0.30	0.00	0.00	0.24	0.00	0.06	0.00	0.09	0.00	0.00	0.00
Crit Moves:	****						****					
Green Time:	0.0	86.2	0.0	0.0	86.2	0.0	24.8	0.0	24.8	0.0	0.0	0.0
Volume/Cap:	0.00	0.42	0.00	0.00	0.34	0.00	0.29	0.00	0.42	0.00	0.00	0.00
Delay/Veh:	0.0	7.0	0.0	0.0	6.4	0.0	40.4	0.0	41.8	0.0	0.0	0.0
User DelAdj:	1.00	1.00	1.00	1.00	1.00	1.00	1.00	1.00	1.00	1.00	1.00	1.00
AdjDel/Veh:	0.0	7.0	0.0	0.0	6.4	0.0	40.4	0.0	41.8	0.0	0.0	0.0
LOS by Move:	A	A	A	A	A	A	D	A	D	A	A	A
HCM2kAvgQ:	0	1	0	0	0	0	4	0	6	0	0	0

Note: Queue reported is the number of cars per lane.

Hamptons Apartments Complex TIA
 SJ15-1612
 Existing PM

Level Of Service Computation Report
 2000 HCM Operations (Future Volume Alternative)
 Existing PP PM

Intersection #9: Wolfe Road / I-280 SB Ramps

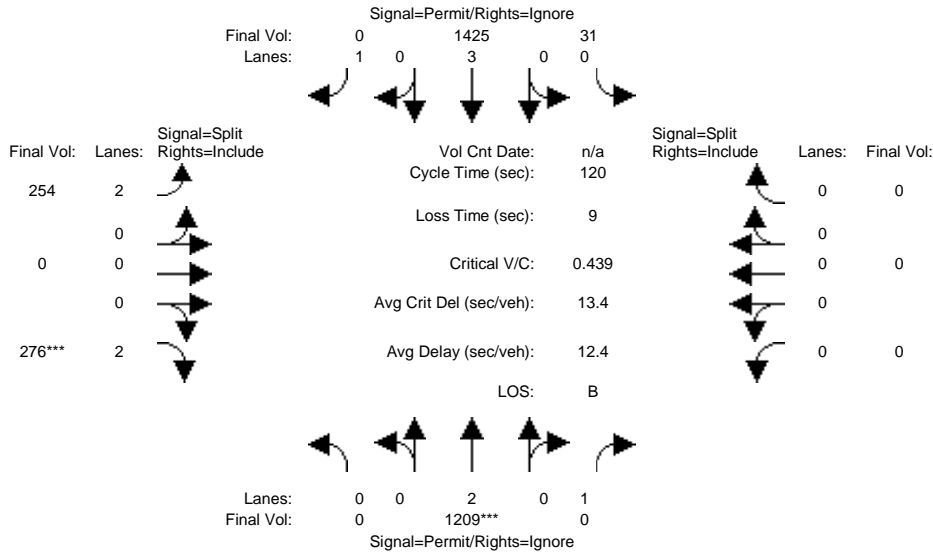

Street Name:	Wolfe Road						I-280 SB Ramps					
Approach:	North Bound			South Bound			East Bound			West Bound		
Movement:	L	T	R	L	T	R	L	T	R	L	T	R
Min. Green:	10	10	10	10	10	10	10	10	10	0	0	0
Y+R:	5.0	5.0	5.0	5.0	5.0	5.0	5.0	5.0	5.0	5.0	5.0	5.0
Volume Module:												
Base Vol:	0	1155	503	0	1394	482	187	0	276	0	0	0
Growth Adj:	1.00	1.00	1.00	1.00	1.00	1.00	1.00	1.00	1.00	1.00	1.00	1.00
Initial Bse:	0	1155	503	0	1394	482	187	0	276	0	0	0
Added Vol:	0	54	0	31	31	0	67	0	0	0	0	0
PasserByVol:	0	0	0	0	0	0	0	0	0	0	0	0
Initial Fut:	0	1209	503	31	1425	482	254	0	276	0	0	0
User Adj:	1.00	1.00	0.00	1.00	1.00	0.00	1.00	1.00	1.00	1.00	1.00	1.00
PHF Adj:	1.00	1.00	0.00	1.00	1.00	0.00	1.00	1.00	1.00	1.00	1.00	1.00
PHF Volume:	0	1209	0	31	1425	0	254	0	276	0	0	0
Reduct Vol:	0	0	0	0	0	0	0	0	0	0	0	0
Reduced Vol:	0	1209	0	31	1425	0	254	0	276	0	0	0
PCE Adj:	1.00	1.00	0.00	1.00	1.00	0.00	1.00	1.00	1.00	1.00	1.00	1.00
MLF Adj:	1.00	1.00	0.00	1.00	1.00	0.00	1.00	1.00	1.00	1.00	1.00	1.00
Final Volume:	0	1209	0	31	1425	0	254	0	276	0	0	0
Saturation Flow Module:												
Sat/Lane:	1900	1900	1900	1900	1900	1900	1900	1900	1900	1900	1900	1900
Adjustment:	0.92	1.00	0.92	0.95	0.98	0.92	0.83	1.00	0.83	0.92	1.00	0.92
Lanes:	0.00	2.00	1.00	0.07	2.93	1.00	2.00	0.00	2.00	0.00	0.00	0.00
Final Sat.:	0	3800	1750	119	5481	1750	3150	0	3150	0	0	0
Capacity Analysis Module:												
Vol/Sat:	0.00	0.32	0.00	0.26	0.26	0.00	0.08	0.00	0.09	0.00	0.00	0.00
Crit Moves:	****						****					
Green Time:	0.0	87.0	0.0	87.0	87.0	0.0	24.0	0.0	24.0	0.0	0.0	0.0
Volume/Cap:	0.00	0.44	0.00	0.36	0.36	0.00	0.40	0.00	0.44	0.00	0.00	0.00
Delay/Veh:	0.0	6.8	0.0	6.2	6.2	0.0	42.2	0.0	42.6	0.0	0.0	0.0
User DelAdj:	1.00	1.00	1.00	1.00	1.00	1.00	1.00	1.00	1.00	1.00	1.00	1.00
AdjDel/Veh:	0.0	6.8	0.0	6.2	6.2	0.0	42.2	0.0	42.6	0.0	0.0	0.0
LOS by Move:	A	A	A	A	A	A	D	A	D	A	A	A
HCM2kAvgQ:	0	1	0	0	0	0	5	0	6	0	0	0

Note: Queue reported is the number of cars per lane.

Hamptons Apartments Complex TIA
 SJ15-1612
 Existing PM

Level Of Service Computation Report
 2000 HCM Operations (Future Volume Alternative)
 Existing PM

Intersection #10: Wolfe Road / Vallco Parkway

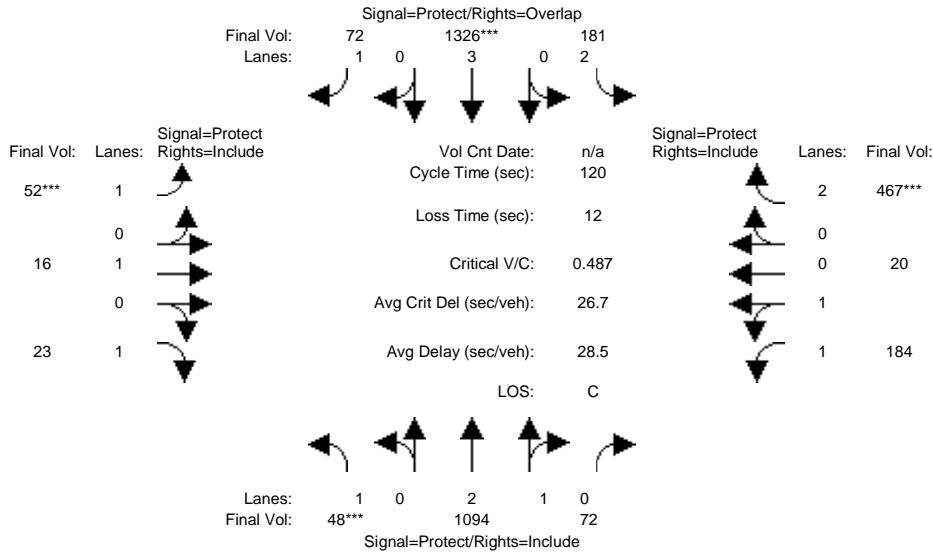

Street Name:	Wolfe Road						Vallco Parkway					
	North Bound			South Bound			East Bound			West Bound		
Approach:	North Bound			South Bound			East Bound			West Bound		
Movement:	L	T	R	L	T	R	L	T	R	L	T	R
Min. Green:	7	10	10	7	10	10	7	10	10	7	10	10
Y+R:	4.0	4.0	4.0	4.0	4.0	4.0	4.0	4.0	4.0	4.0	4.0	4.0

Volume Module:												
Base Vol:	48	1094	72	181	1326	72	52	16	23	184	20	467
Growth Adj:	1.00	1.00	1.00	1.00	1.00	1.00	1.00	1.00	1.00	1.00	1.00	1.00
Initial Bse:	48	1094	72	181	1326	72	52	16	23	184	20	467
Added Vol:	0	0	0	0	0	0	0	0	0	0	0	0
PasserByVol:	0	0	0	0	0	0	0	0	0	0	0	0
Initial Fut:	48	1094	72	181	1326	72	52	16	23	184	20	467
User Adj:	1.00	1.00	1.00	1.00	1.00	1.00	1.00	1.00	1.00	1.00	1.00	1.00
PHF Adj:	1.00	1.00	1.00	1.00	1.00	1.00	1.00	1.00	1.00	1.00	1.00	1.00
PHF Volume:	48	1094	72	181	1326	72	52	16	23	184	20	467
Reduct Vol:	0	0	0	0	0	0	0	0	0	0	0	0
Reduced Vol:	48	1094	72	181	1326	72	52	16	23	184	20	467
PCE Adj:	1.00	1.00	1.00	1.00	1.00	1.00	1.00	1.00	1.00	1.00	1.00	1.00
MLF Adj:	1.00	1.00	1.00	1.00	1.00	1.00	1.00	1.00	1.00	1.00	1.00	1.00
Final Volume:	48	1094	72	181	1326	72	52	16	23	184	20	467

Saturation Flow Module:												
Sat/Lane:	1900	1900	1900	1900	1900	1900	1900	1900	1900	1900	1900	1900
Adjustment:	0.92	0.98	0.95	0.83	1.00	0.92	0.92	1.00	0.92	0.93	0.95	0.83
Lanes:	1.00	2.81	0.19	2.00	3.00	1.00	1.00	1.00	1.00	1.81	0.19	2.00
Final Sat.:	1750	5254	346	3150	5700	1750	1750	1900	1750	3202	348	3150

Capacity Analysis Module:												
Vol/Sat:	0.03	0.21	0.21	0.06	0.23	0.04	0.03	0.01	0.01	0.06	0.06	0.15
Crit Moves:	***			****			****			****		
Green Time:	7.0	50.2	50.2	14.1	57.2	64.5	7.3	25.8	25.8	18.0	36.5	36.5
Volume/Cap:	0.47	0.50	0.50	0.49	0.49	0.08	0.49	0.04	0.06	0.38	0.19	0.49
Delay/Veh:	58.1	25.8	25.8	50.6	21.5	13.4	58.0	37.4	37.6	46.4	30.9	34.5
User DelAdj:	1.00	1.00	1.00	1.00	1.00	1.00	1.00	1.00	1.00	1.00	1.00	1.00
AdjDel/Veh:	58.1	25.8	25.8	50.6	21.5	13.4	58.0	37.4	37.6	46.4	30.9	34.5
LOS by Move:	E+	C	C	D	C+	B	E+	D+	D+	D	C	C-
HCM2kAvgQ:	2	10	10	4	11	1	3	0	1	4	3	8

Note: Queue reported is the number of cars per lane.

Hamptons Apartments Complex TIA
 SJ15-1612
 Existing PM

Level Of Service Computation Report
 2000 HCM Operations (Future Volume Alternative)
 Existing PP PM

Intersection #10: Wolfe Road / Vallco Parkway

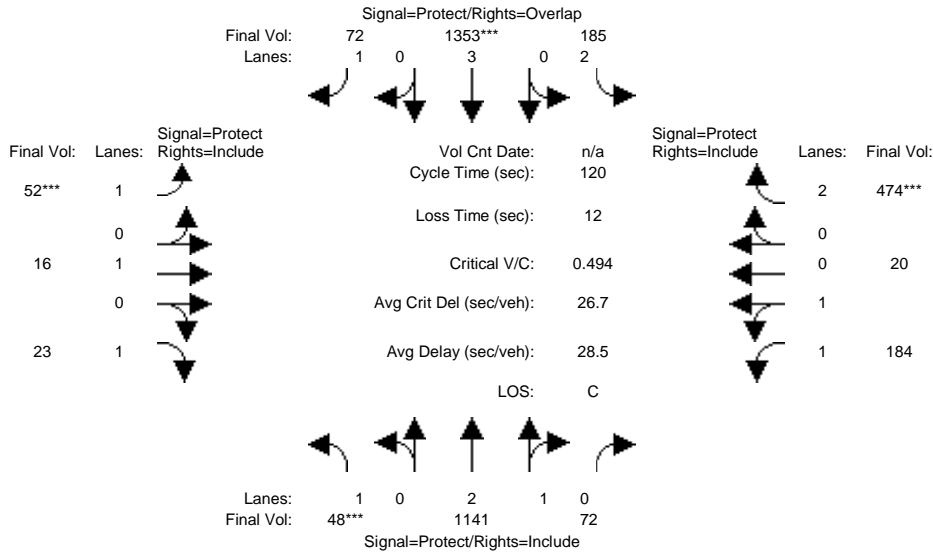

Street Name:	Wolfe Road						Vallco Parkway					
	North Bound			South Bound			East Bound			West Bound		
Approach:	North Bound			South Bound			East Bound			West Bound		
Movement:	L	T	R	L	T	R	L	T	R	L	T	R
Min. Green:	7	10	10	7	10	10	7	10	10	7	10	10
Y+R:	4.0	4.0	4.0	4.0	4.0	4.0	4.0	4.0	4.0	4.0	4.0	4.0

Volume Module:												
Base Vol:	48	1094	72	181	1326	72	52	16	23	184	20	467
Growth Adj:	1.00	1.00	1.00	1.00	1.00	1.00	1.00	1.00	1.00	1.00	1.00	1.00
Initial Bse:	48	1094	72	181	1326	72	52	16	23	184	20	467
Added Vol:	0	47	0	4	27	0	0	0	0	0	0	7
PasserByVol:	0	0	0	0	0	0	0	0	0	0	0	0
Initial Fut:	48	1141	72	185	1353	72	52	16	23	184	20	474
User Adj:	1.00	1.00	1.00	1.00	1.00	1.00	1.00	1.00	1.00	1.00	1.00	1.00
PHF Adj:	1.00	1.00	1.00	1.00	1.00	1.00	1.00	1.00	1.00	1.00	1.00	1.00
PHF Volume:	48	1141	72	185	1353	72	52	16	23	184	20	474
Reduct Vol:	0	0	0	0	0	0	0	0	0	0	0	0
Reduced Vol:	48	1141	72	185	1353	72	52	16	23	184	20	474
PCE Adj:	1.00	1.00	1.00	1.00	1.00	1.00	1.00	1.00	1.00	1.00	1.00	1.00
MLF Adj:	1.00	1.00	1.00	1.00	1.00	1.00	1.00	1.00	1.00	1.00	1.00	1.00
Final Volume:	48	1141	72	185	1353	72	52	16	23	184	20	474

Saturation Flow Module:												
Sat/Lane:	1900	1900	1900	1900	1900	1900	1900	1900	1900	1900	1900	1900
Adjustment:	0.92	0.98	0.95	0.83	1.00	0.92	0.92	1.00	0.92	0.93	0.95	0.83
Lanes:	1.00	2.82	0.18	2.00	3.00	1.00	1.00	1.00	1.00	1.81	0.19	2.00
Final Sat.:	1750	5267	332	3150	5700	1750	1750	1900	1750	3202	348	3150

Capacity Analysis Module:												
Vol/Sat:	0.03	0.22	0.22	0.06	0.24	0.04	0.03	0.01	0.01	0.06	0.06	0.15
Crit Moves:	***			****			****					****
Green Time:	7.0	50.7	50.7	13.7	57.4	64.6	7.2	25.6	25.6	17.9	36.4	36.4
Volume/Cap:	0.47	0.51	0.51	0.51	0.50	0.08	0.50	0.04	0.06	0.38	0.19	0.50
Delay/Veh:	58.1	25.8	25.8	51.2	21.5	13.4	58.3	37.5	37.7	46.5	31.0	34.7
User DelAdj:	1.00	1.00	1.00	1.00	1.00	1.00	1.00	1.00	1.00	1.00	1.00	1.00
AdjDel/Veh:	58.1	25.8	25.8	51.2	21.5	13.4	58.3	37.5	37.7	46.5	31.0	34.7
LOS by Move:	E+	C	C	D-	C+	B	E+	D+	D+	D	C	C-
HCM2kAvgQ:	2	11	11	4	11	1	3	0	1	4	3	8

Note: Queue reported is the number of cars per lane.

Hamptons Apartments Complex TIA
 SJ15-1612
 Existing PM

Level Of Service Computation Report
 2000 HCM Operations (Future Volume Alternative)
 Existing PM

Intersection #11: Wolfe Road / Stevens Creek Boulevard

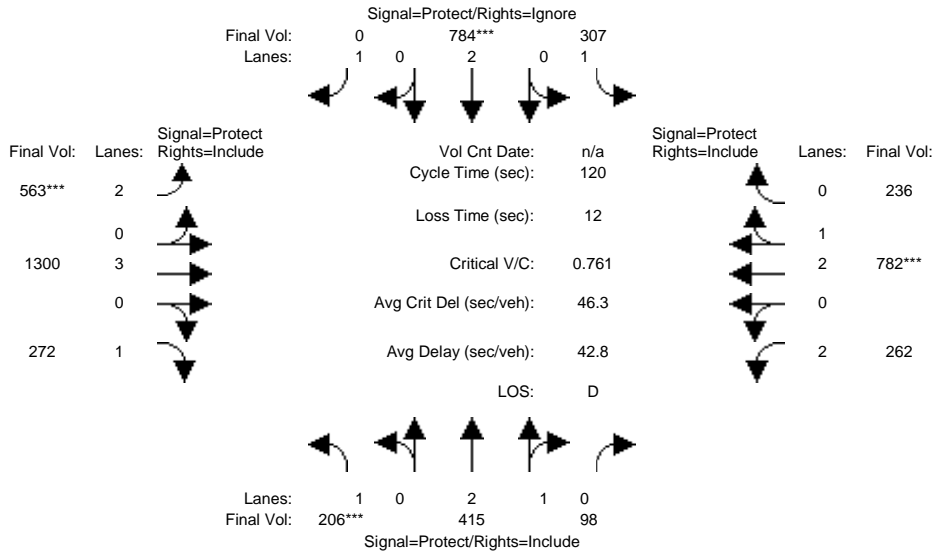

Street Name:	Wolfe Road						Stevens Creek Boulevard					
	North Bound			South Bound			East Bound			West Bound		
Approach:												
Movement:	L	T	R	L	T	R	L	T	R	L	T	R
Min. Green:	7	10	10	7	10	10	7	10	10	7	10	10
Y+R:	5.0	5.0	5.0	5.0	5.0	5.0	5.0	5.0	5.0	5.0	5.0	5.0

Volume Module:												
Base Vol:	206	415	98	307	784	443	563	1300	272	262	782	236
Growth Adj:	1.00	1.00	1.00	1.00	1.00	1.00	1.00	1.00	1.00	1.00	1.00	1.00
Initial Bse:	206	415	98	307	784	443	563	1300	272	262	782	236
Added Vol:	0	0	0	0	0	0	0	0	0	0	0	0
PasserByVol:	0	0	0	0	0	0	0	0	0	0	0	0
Initial Fut:	206	415	98	307	784	443	563	1300	272	262	782	236
User Adj:	1.00	1.00	1.00	1.00	1.00	0.00	1.00	1.00	1.00	1.00	1.00	1.00
PHF Adj:	1.00	1.00	1.00	1.00	1.00	0.00	1.00	1.00	1.00	1.00	1.00	1.00
PHF Volume:	206	415	98	307	784	0	563	1300	272	262	782	236
Reduct Vol:	0	0	0	0	0	0	0	0	0	0	0	0
Reduced Vol:	206	415	98	307	784	0	563	1300	272	262	782	236
PCE Adj:	1.00	1.00	1.00	1.00	1.00	0.00	1.00	1.00	1.00	1.00	1.00	1.00
MLF Adj:	1.00	1.00	1.00	1.00	1.00	0.00	1.00	1.00	1.00	1.00	1.00	1.00
Final Volume:	206	415	98	307	784	0	563	1300	272	262	782	236

Saturation Flow Module:												
Sat/Lane:	1900	1900	1900	1900	1900	1900	1900	1900	1900	1900	1900	1900
Adjustment:	0.92	0.99	0.95	0.92	1.00	0.92	0.83	1.00	0.92	0.83	0.99	0.95
Lanes:	1.00	2.41	0.59	1.00	2.00	1.00	2.00	3.00	1.00	2.00	2.28	0.72
Final Sat.:	1750	4529	1069	1750	3800	1750	3150	5700	1750	3150	4300	1298

Capacity Analysis Module:												
Vol/Sat:	0.12	0.09	0.09	0.18	0.21	0.00	0.18	0.23	0.16	0.08	0.18	0.18
Crit Moves:	***			****			****			****		
Green Time:	18.6	17.5	17.5	33.6	32.5	0.0	28.2	41.7	41.7	15.2	28.7	28.7
Volume/Cap:	0.76	0.63	0.63	0.63	0.76	0.00	0.76	0.66	0.45	0.66	0.76	0.76
Delay/Veh:	60.5	49.7	49.7	40.3	43.5	0.0	47.4	33.9	30.8	53.9	45.1	45.1
User DelAdj:	1.00	1.00	1.00	1.00	1.00	1.00	1.00	1.00	1.00	1.00	1.00	1.00
AdjDel/Veh:	60.5	49.7	49.7	40.3	43.5	0.0	47.4	33.9	30.8	53.9	45.1	45.1
LOS by Move:	E	D	D	D	D	A	D	C-	C	D-	D	D
HCM2kAvgQ:	9	7	7	10	13	0	11	11	6	5	11	11

Note: Queue reported is the number of cars per lane.

Hamptons Apartments Complex TIA
 SJ15-1612
 Existing PM

Level Of Service Computation Report
 2000 HCM Operations (Future Volume Alternative)
 Existing PP PM

Intersection #11: Wolfe Road / Stevens Creek Boulevard

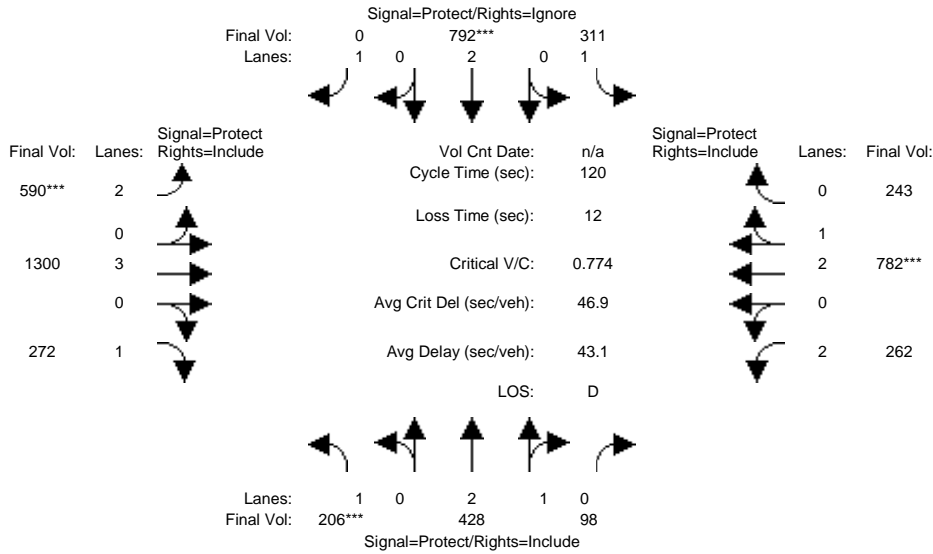

Street Name:	Wolfe Road						Stevens Creek Boulevard					
	North Bound			South Bound			East Bound			West Bound		
Approach:	North Bound			South Bound			East Bound			West Bound		
Movement:	L	T	R	L	T	R	L	T	R	L	T	R
Min. Green:	7	10	10	7	10	10	7	10	10	7	10	10
Y+R:	5.0	5.0	5.0	5.0	5.0	5.0	5.0	5.0	5.0	5.0	5.0	5.0

Volume Module:												
Base Vol:	206	415	98	307	784	443	563	1300	272	262	782	236
Growth Adj:	1.00	1.00	1.00	1.00	1.00	1.00	1.00	1.00	1.00	1.00	1.00	1.00
Initial Bse:	206	415	98	307	784	443	563	1300	272	262	782	236
Added Vol:	0	13	0	4	8	15	27	0	0	0	0	7
PasserByVol:	0	0	0	0	0	0	0	0	0	0	0	0
Initial Fut:	206	428	98	311	792	458	590	1300	272	262	782	243
User Adj:	1.00	1.00	1.00	1.00	1.00	0.00	1.00	1.00	1.00	1.00	1.00	1.00
PHF Adj:	1.00	1.00	1.00	1.00	1.00	0.00	1.00	1.00	1.00	1.00	1.00	1.00
PHF Volume:	206	428	98	311	792	0	590	1300	272	262	782	243
Reduct Vol:	0	0	0	0	0	0	0	0	0	0	0	0
Reduced Vol:	206	428	98	311	792	0	590	1300	272	262	782	243
PCE Adj:	1.00	1.00	1.00	1.00	1.00	0.00	1.00	1.00	1.00	1.00	1.00	1.00
MLF Adj:	1.00	1.00	1.00	1.00	1.00	0.00	1.00	1.00	1.00	1.00	1.00	1.00
Final Volume:	206	428	98	311	792	0	590	1300	272	262	782	243

Saturation Flow Module:												
Sat/Lane:	1900	1900	1900	1900	1900	1900	1900	1900	1900	1900	1900	1900
Adjustment:	0.92	0.99	0.95	0.92	1.00	0.92	0.83	1.00	0.92	0.83	0.99	0.95
Lanes:	1.00	2.42	0.58	1.00	2.00	1.00	2.00	3.00	1.00	2.00	2.26	0.74
Final Sat.:	1750	4555	1043	1750	3800	1750	3150	5700	1750	3150	4271	1327

Capacity Analysis Module:												
Vol/Sat:	0.12	0.09	0.09	0.18	0.21	0.00	0.19	0.23	0.16	0.08	0.18	0.18
Crit Moves:	***			****			****			****		
Green Time:	18.3	17.5	17.5	33.1	32.3	0.0	29.0	42.1	42.1	15.3	28.4	28.4
Volume/Cap:	0.77	0.64	0.64	0.64	0.77	0.00	0.77	0.65	0.44	0.65	0.77	0.77
Delay/Veh:	62.1	50.1	50.1	41.3	44.2	0.0	47.4	33.5	30.5	53.5	45.7	45.7
User DelAdj:	1.00	1.00	1.00	1.00	1.00	1.00	1.00	1.00	1.00	1.00	1.00	1.00
AdjDel/Veh:	62.1	50.1	50.1	41.3	44.2	0.0	47.4	33.5	30.5	53.5	45.7	45.7
LOS by Move:	E	D	D	D	D	A	D	C-	C	D-	D	D
HCM2kAvgQ:	10	7	7	10	13	0	11	11	6	5	12	12

Note: Queue reported is the number of cars per lane.

Hamptons Apartments Complex TIA
 SJ15-1612
 Existing PM

Level Of Service Computation Report
 2000 HCM Operations (Future Volume Alternative)
 Existing PM

Intersection #12: De Anza Boulevard / Stevens Creek Boulevard

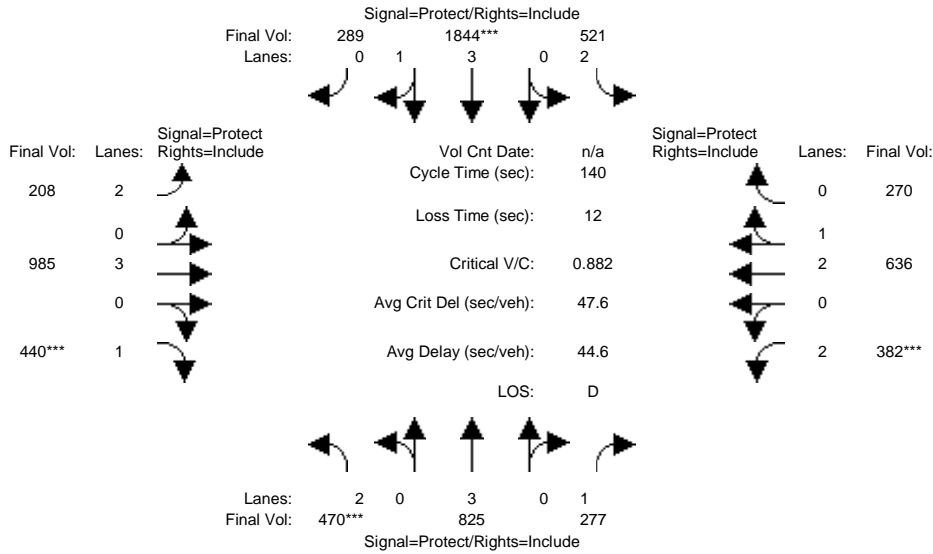

Street Name:	De Anza Boulevard						Stevens Creek Boulevard					
	North Bound			South Bound			East Bound			West Bound		
Approach:	L	T	R	L	T	R	L	T	R	L	T	R
Min. Green:	7	10	10	7	10	10	7	10	10	7	10	10
Y+R:	5.0	5.0	5.0	5.0	5.0	5.0	5.0	5.0	5.0	5.0	5.0	5.0

Volume Module:												
Base Vol:	470	825	277	521	1844	289	208	985	440	382	636	270
Growth Adj:	1.00	1.00	1.00	1.00	1.00	1.00	1.00	1.00	1.00	1.00	1.00	1.00
Initial Bse:	470	825	277	521	1844	289	208	985	440	382	636	270
Added Vol:	0	0	0	0	0	0	0	0	0	0	0	0
PasserByVol:	0	0	0	0	0	0	0	0	0	0	0	0
Initial Fut:	470	825	277	521	1844	289	208	985	440	382	636	270
User Adj:	1.00	1.00	1.00	1.00	1.00	1.00	1.00	1.00	1.00	1.00	1.00	1.00
PHF Adj:	1.00	1.00	1.00	1.00	1.00	1.00	1.00	1.00	1.00	1.00	1.00	1.00
PHF Volume:	470	825	277	521	1844	289	208	985	440	382	636	270
Reduct Vol:	0	0	0	0	0	0	0	0	0	0	0	0
Reduced Vol:	470	825	277	521	1844	289	208	985	440	382	636	270
PCE Adj:	1.00	1.00	1.00	1.00	1.00	1.00	1.00	1.00	1.00	1.00	1.00	1.00
MLF Adj:	1.00	1.00	1.00	1.00	1.00	1.00	1.00	1.00	1.00	1.00	1.00	1.00
Final Volume:	470	825	277	521	1844	289	208	985	440	382	636	270

Saturation Flow Module:												
Sat/Lane:	1900	1900	1900	1900	1900	1900	1900	1900	1900	1900	1900	1900
Adjustment:	0.83	1.00	0.92	0.83	0.99	0.95	0.83	1.00	0.92	0.83	1.00	0.95
Lanes:	2.00	3.00	1.00	2.00	3.44	0.56	2.00	3.00	1.00	2.00	2.07	0.93
Final Sat.:	3150	5700	1750	3150	6482	1016	3150	5700	1750	3150	3929	1668

Capacity Analysis Module:												
Vol/Sat:	0.15	0.14	0.16	0.17	0.28	0.28	0.07	0.17	0.25	0.12	0.16	0.16
Crit Moves:	***			****			****		****	****		
Green Time:	23.7	33.7	33.7	35.2	45.2	45.2	17.1	39.9	39.9	19.2	42.0	42.0
Volume/Cap:	0.88	0.60	0.66	0.66	0.88	0.88	0.54	0.61	0.88	0.88	0.54	0.54
Delay/Veh:	64.9	38.0	41.7	38.5	34.8	34.8	59.3	43.9	64.4	77.9	41.3	41.3
User DelAdj:	1.00	1.00	1.00	1.00	1.00	1.00	1.00	1.00	1.00	1.00	1.00	1.00
AdjDel/Veh:	64.9	38.0	41.7	38.5	34.8	34.8	59.3	43.9	64.4	77.9	41.3	41.3
LOS by Move:	E	D+	D	D+	C-	C-	E+	D	E	E-	D	D
HCM2kAvgQ:	15	10	11	12	23	23	6	12	22	10	10	10

Note: Queue reported is the number of cars per lane.

Hamptons Apartments Complex TIA
 SJ15-1612
 Existing PM

Level Of Service Computation Report
 2000 HCM Operations (Future Volume Alternative)
 Existing PP PM

Intersection #12: De Anza Boulevard / Stevens Creek Boulevard

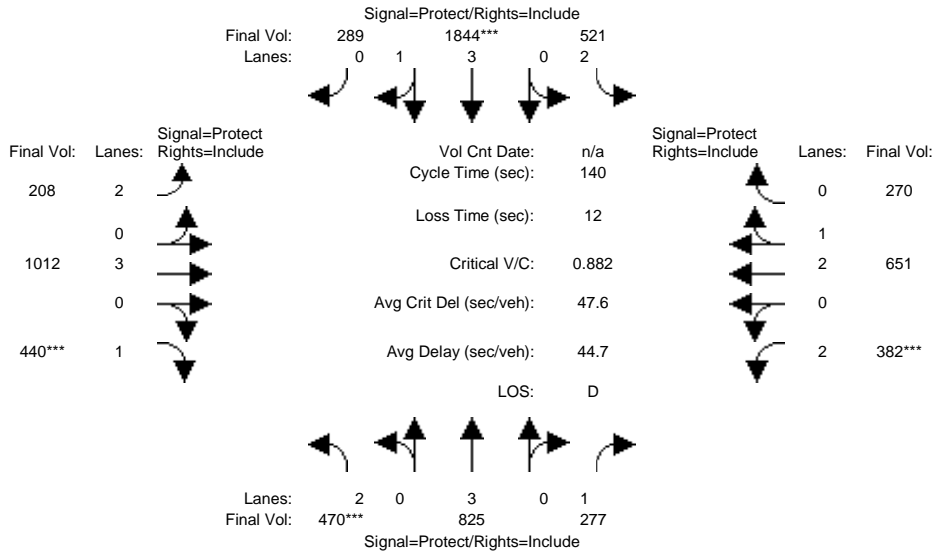

Street Name:	De Anza Boulevard						Stevens Creek Boulevard					
	North Bound			South Bound			East Bound			West Bound		
Approach:												
Movement:	L	T	R	L	T	R	L	T	R	L	T	R
Min. Green:	7	10	10	7	10	10	7	10	10	7	10	10
Y+R:	5.0	5.0	5.0	5.0	5.0	5.0	5.0	5.0	5.0	5.0	5.0	5.0

Volume Module:												
Base Vol:	470	825	277	521	1844	289	208	985	440	382	636	270
Growth Adj:	1.00	1.00	1.00	1.00	1.00	1.00	1.00	1.00	1.00	1.00	1.00	1.00
Initial Bse:	470	825	277	521	1844	289	208	985	440	382	636	270
Added Vol:	0	0	0	0	0	0	0	27	0	0	15	0
PasserByVol:	0	0	0	0	0	0	0	0	0	0	0	0
Initial Fut:	470	825	277	521	1844	289	208	1012	440	382	651	270
User Adj:	1.00	1.00	1.00	1.00	1.00	1.00	1.00	1.00	1.00	1.00	1.00	1.00
PHF Adj:	1.00	1.00	1.00	1.00	1.00	1.00	1.00	1.00	1.00	1.00	1.00	1.00
PHF Volume:	470	825	277	521	1844	289	208	1012	440	382	651	270
Reduct Vol:	0	0	0	0	0	0	0	0	0	0	0	0
Reduced Vol:	470	825	277	521	1844	289	208	1012	440	382	651	270
PCE Adj:	1.00	1.00	1.00	1.00	1.00	1.00	1.00	1.00	1.00	1.00	1.00	1.00
MLF Adj:	1.00	1.00	1.00	1.00	1.00	1.00	1.00	1.00	1.00	1.00	1.00	1.00
Final Volume:	470	825	277	521	1844	289	208	1012	440	382	651	270

Saturation Flow Module:												
Sat/Lane:	1900	1900	1900	1900	1900	1900	1900	1900	1900	1900	1900	1900
Adjustment:	0.83	1.00	0.92	0.83	0.99	0.95	0.83	1.00	0.92	0.83	1.00	0.95
Lanes:	2.00	3.00	1.00	2.00	3.44	0.56	2.00	3.00	1.00	2.00	2.09	0.91
Final Sat.:	3150	5700	1750	3150	6482	1016	3150	5700	1750	3150	3956	1641

Capacity Analysis Module:												
Vol/Sat:	0.15	0.14	0.16	0.17	0.28	0.28	0.07	0.18	0.25	0.12	0.16	0.16
Crit Moves:	***			****					****	****		
Green Time:	23.7	33.7	33.7	35.2	45.2	45.2	16.9	39.9	39.9	19.2	42.2	42.2
Volume/Cap:	0.88	0.60	0.66	0.66	0.88	0.88	0.55	0.62	0.88	0.88	0.55	0.55
Delay/Veh:	64.9	38.0	41.7	38.5	34.8	34.8	59.6	44.3	64.4	77.9	41.2	41.2
User DelAdj:	1.00	1.00	1.00	1.00	1.00	1.00	1.00	1.00	1.00	1.00	1.00	1.00
AdjDel/Veh:	64.9	38.0	41.7	38.5	34.8	34.8	59.6	44.3	64.4	77.9	41.2	41.2
LOS by Move:	E	D+	D	D+	C-	C-	E+	D	E	E-	D	D
HCM2kAvgQ:	15	10	11	12	23	23	6	12	22	10	10	10

Note: Queue reported is the number of cars per lane.

Hamptons Apartments Complex TIA
 SJ15-1612
 Existing PM

Level Of Service Computation Report
 2000 HCM Operations (Future Volume Alternative)
 Existing PM

Intersection #13: Tantau Avenue / Homestead Road

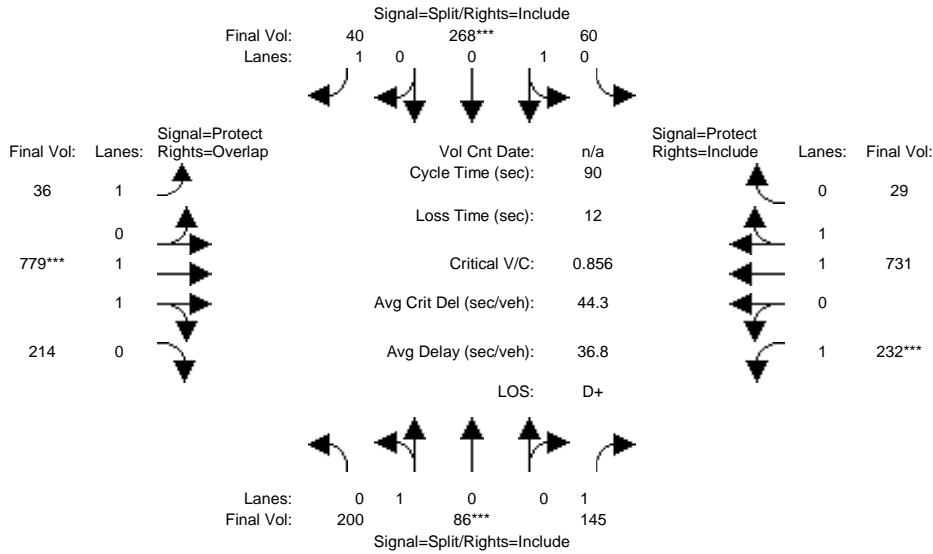

Street Name:	Tantau Avenue						Homestead Road					
	North Bound			South Bound			East Bound			West Bound		
Approach:	North Bound			South Bound			East Bound			West Bound		
Movement:	L	T	R	L	T	R	L	T	R	L	T	R
Min. Green:	10	10	10	10	10	10	7	10	10	7	10	10
Y+R:	4.0	4.0	4.0	4.0	4.0	4.0	4.0	4.0	4.0	4.0	4.0	4.0

Volume Module:												
Base Vol:	200	86	145	60	268	40	36	779	214	232	731	29
Growth Adj:	1.00	1.00	1.00	1.00	1.00	1.00	1.00	1.00	1.00	1.00	1.00	1.00
Initial Bse:	200	86	145	60	268	40	36	779	214	232	731	29
Added Vol:	0	0	0	0	0	0	0	0	0	0	0	0
PasserByVol:	0	0	0	0	0	0	0	0	0	0	0	0
Initial Fut:	200	86	145	60	268	40	36	779	214	232	731	29
User Adj:	1.00	1.00	1.00	1.00	1.00	1.00	1.00	1.00	1.00	1.00	1.00	1.00
PHF Adj:	1.00	1.00	1.00	1.00	1.00	1.00	1.00	1.00	1.00	1.00	1.00	1.00
PHF Volume:	200	86	145	60	268	40	36	779	214	232	731	29
Reduct Vol:	0	0	0	0	0	0	0	0	0	0	0	0
Reduced Vol:	200	86	145	60	268	40	36	779	214	232	731	29
PCE Adj:	1.00	1.00	1.00	1.00	1.00	1.00	1.00	1.00	1.00	1.00	1.00	1.00
MLF Adj:	1.00	1.00	1.00	1.00	1.00	1.00	1.00	1.00	1.00	1.00	1.00	1.00
Final Volume:	200	86	145	60	268	40	36	779	214	232	731	29

Saturation Flow Module:												
Sat/Lane:	1900	1900	1900	1900	1900	1900	1900	1900	1900	1900	1900	1900
Adjustment:	0.95	0.95	0.92	0.95	0.95	0.92	0.92	0.98	0.95	0.92	0.97	0.95
Lanes:	0.70	0.30	1.00	0.18	0.82	1.00	1.00	1.56	0.44	1.00	1.92	0.08
Final Sat.:	1259	541	1750	329	1471	1750	1750	2902	797	1750	3559	141

Capacity Analysis Module:												
Vol/Sat:	0.16	0.16	0.08	0.18	0.18	0.02	0.02	0.27	0.27	0.13	0.21	0.21
Crit Moves:	****			****			****			****		
Green Time:	16.7	16.7	16.7	19.2	19.2	19.2	11.6	28.2	44.9	13.9	30.6	30.6
Volume/Cap:	0.86	0.86	0.45	0.86	0.86	0.11	0.16	0.86	0.54	0.86	0.60	0.60
Delay/Veh:	54.6	54.6	33.5	51.2	51.2	28.7	35.2	35.5	15.8	59.6	25.5	25.5
User DelAdj:	1.00	1.00	1.00	1.00	1.00	1.00	1.00	1.00	1.00	1.00	1.00	1.00
AdjDel/Veh:	54.6	54.6	33.5	51.2	51.2	28.7	35.2	35.5	15.8	59.6	25.5	25.5
LOS by Move:	D-	D-	C-	D-	D-	C	D+	D+	B	E+	C	C
HCM2kAvgQ:	11	11	4	12	12	1	1	14	9	7	8	8

Note: Queue reported is the number of cars per lane.

Hamptons Apartments Complex TIA
 SJ15-1612
 Existing PM

Level Of Service Computation Report
 2000 HCM Operations (Future Volume Alternative)
 Existing PP PM

Intersection #13: Tantau Avenue / Homestead Road

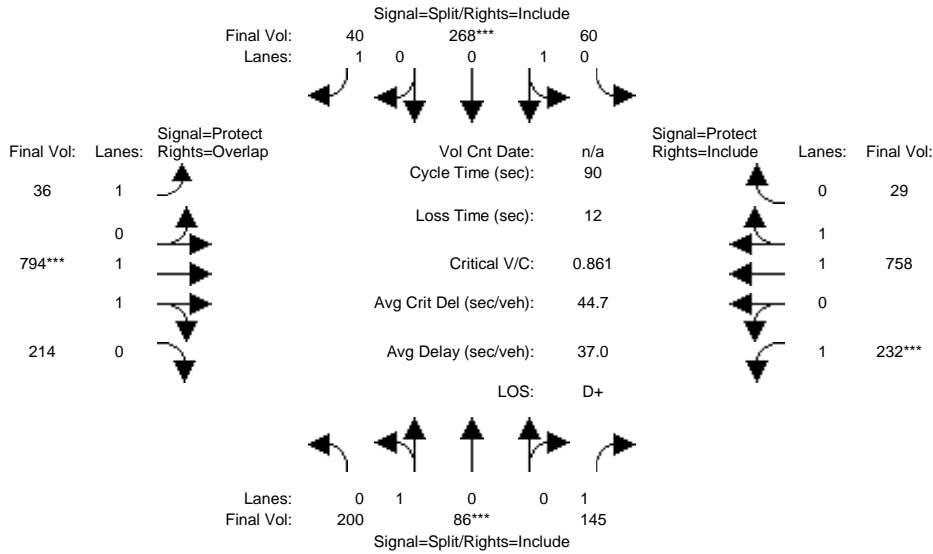

Street Name:	Tantau Avenue						Homestead Road					
	North Bound			South Bound			East Bound			West Bound		
Approach:	North Bound			South Bound			East Bound			West Bound		
Movement:	L	T	R	L	T	R	L	T	R	L	T	R
Min. Green:	10	10	10	10	10	10	7	10	10	7	10	10
Y+R:	4.0	4.0	4.0	4.0	4.0	4.0	4.0	4.0	4.0	4.0	4.0	4.0

Volume Module:												
Base Vol:	200	86	145	60	268	40	36	779	214	232	731	29
Growth Adj:	1.00	1.00	1.00	1.00	1.00	1.00	1.00	1.00	1.00	1.00	1.00	1.00
Initial Bse:	200	86	145	60	268	40	36	779	214	232	731	29
Added Vol:	0	0	0	0	0	0	0	15	0	0	27	0
PasserByVol:	0	0	0	0	0	0	0	0	0	0	0	0
Initial Fut:	200	86	145	60	268	40	36	794	214	232	758	29
User Adj:	1.00	1.00	1.00	1.00	1.00	1.00	1.00	1.00	1.00	1.00	1.00	1.00
PHF Adj:	1.00	1.00	1.00	1.00	1.00	1.00	1.00	1.00	1.00	1.00	1.00	1.00
PHF Volume:	200	86	145	60	268	40	36	794	214	232	758	29
Reduct Vol:	0	0	0	0	0	0	0	0	0	0	0	0
Reduced Vol:	200	86	145	60	268	40	36	794	214	232	758	29
PCE Adj:	1.00	1.00	1.00	1.00	1.00	1.00	1.00	1.00	1.00	1.00	1.00	1.00
MLF Adj:	1.00	1.00	1.00	1.00	1.00	1.00	1.00	1.00	1.00	1.00	1.00	1.00
Final Volume:	200	86	145	60	268	40	36	794	214	232	758	29

Saturation Flow Module:												
Sat/Lane:	1900	1900	1900	1900	1900	1900	1900	1900	1900	1900	1900	1900
Adjustment:	0.95	0.95	0.92	0.95	0.95	0.92	0.92	0.98	0.95	0.92	0.97	0.95
Lanes:	0.70	0.30	1.00	0.18	0.82	1.00	1.00	1.56	0.44	1.00	1.92	0.08
Final Sat.:	1259	541	1750	329	1471	1750	1750	2914	785	1750	3564	136

Capacity Analysis Module:												
Vol/Sat:	0.16	0.16	0.08	0.18	0.18	0.02	0.02	0.27	0.27	0.13	0.21	0.21
Crit Moves:	****			****			****			****		
Green Time:	16.6	16.6	16.6	19.0	19.0	19.0	11.3	28.5	45.1	13.9	31.0	31.0
Volume/Cap:	0.86	0.86	0.45	0.86	0.86	0.11	0.16	0.86	0.54	0.86	0.62	0.62
Delay/Veh:	55.4	55.4	33.6	51.9	51.9	28.8	35.4	35.6	15.7	60.5	25.5	25.5
User DelAdj:	1.00	1.00	1.00	1.00	1.00	1.00	1.00	1.00	1.00	1.00	1.00	1.00
AdjDel/Veh:	55.4	55.4	33.6	51.9	51.9	28.8	35.4	35.6	15.7	60.5	25.5	25.5
LOS by Move:	E+	E+	C-	D-	D-	C	D+	D+	B	E	C	C
HCM2kAvgQ:	11	11	4	12	12	1	1	15	10	7	9	9

Note: Queue reported is the number of cars per lane.

Hamptons Apartments Complex TIA
 SJ15-1612
 Existing PM

Level Of Service Computation Report
 2000 HCM Operations (Future Volume Alternative)
 Existing PM

Intersection #14: Tantau Avenue / Vallco Parkway

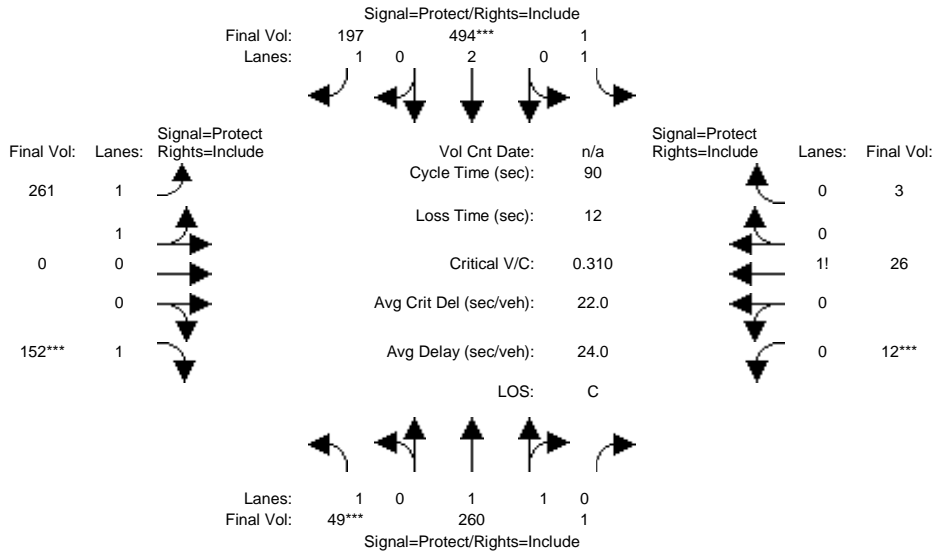

Street Name:	Tantau Avenue						Vallco Parkway					
	North Bound			South Bound			East Bound			West Bound		
Approach:	North Bound			South Bound			East Bound			West Bound		
Movement:	L	T	R	L	T	R	L	T	R	L	T	R
Min. Green:	7	10	10	7	10	10	7	10	10	7	10	10
Y+R:	4.0	4.0	4.0	4.0	4.0	4.0	4.0	4.0	4.0	4.0	4.0	4.0

Volume Module:												
Base Vol:	49	260	1	1	494	197	261	0	152	12	26	3
Growth Adj:	1.00	1.00	1.00	1.00	1.00	1.00	1.00	1.00	1.00	1.00	1.00	1.00
Initial Bse:	49	260	1	1	494	197	261	0	152	12	26	3
Added Vol:	0	0	0	0	0	0	0	0	0	0	0	0
PasserByVol:	0	0	0	0	0	0	0	0	0	0	0	0
Initial Fut:	49	260	1	1	494	197	261	0	152	12	26	3
User Adj:	1.00	1.00	1.00	1.00	1.00	1.00	1.00	1.00	1.00	1.00	1.00	1.00
PHF Adj:	1.00	1.00	1.00	1.00	1.00	1.00	1.00	1.00	1.00	1.00	1.00	1.00
PHF Volume:	49	260	1	1	494	197	261	0	152	12	26	3
Reduct Vol:	0	0	0	0	0	0	0	0	0	0	0	0
Reduced Vol:	49	260	1	1	494	197	261	0	152	12	26	3
PCE Adj:	1.00	1.00	1.00	1.00	1.00	1.00	1.00	1.00	1.00	1.00	1.00	1.00
MLF Adj:	1.00	1.00	1.00	1.00	1.00	1.00	1.00	1.00	1.00	1.00	1.00	1.00
Final Volume:	49	260	1	1	494	197	261	0	152	12	26	3

Saturation Flow Module:												
Sat/Lane:	1900	1900	1900	1900	1900	1900	1900	1900	1900	1900	1900	1900
Adjustment:	0.92	0.97	0.95	0.92	1.00	0.92	0.93	1.00	0.92	0.92	0.92	0.92
Lanes:	1.00	1.99	0.01	1.00	2.00	1.00	2.00	0.00	1.00	0.29	0.64	0.07
Final Sat.:	1750	3686	14	1750	3800	1750	3550	0	1750	512	1110	128

Capacity Analysis Module:												
Vol/Sat:	0.03	0.07	0.07	0.00	0.13	0.11	0.07	0.00	0.09	0.02	0.02	0.02
Crit Moves:	***			****			****		****	****		
Green Time:	8.1	26.9	26.9	18.9	37.7	37.7	13.3	0.0	25.2	7.0	18.9	18.9
Volume/Cap:	0.31	0.24	0.24	0.00	0.31	0.27	0.50	0.00	0.31	0.30	0.11	0.11
Delay/Veh:	39.4	23.9	23.9	28.1	17.6	17.3	36.1	0.0	25.9	40.4	28.9	28.9
User DelAdj:	1.00	1.00	1.00	1.00	1.00	1.00	1.00	1.00	1.00	1.00	1.00	1.00
AdjDel/Veh:	39.4	23.9	23.9	28.1	17.6	17.3	36.1	0.0	25.9	40.4	28.9	28.9
LOS by Move:	D	C	C	C	B	B	D+	A	C	D	C	C
HCM2kAvgQ:	1	3	3	0	5	4	4	0	3	1	1	1

Note: Queue reported is the number of cars per lane.

Hamptons Apartments Complex TIA
 SJ15-1612
 Existing PM

Level Of Service Computation Report
 2000 HCM Operations (Future Volume Alternative)
 Existing PP PM

Intersection #14: Tantau Avenue / Vallco Parkway

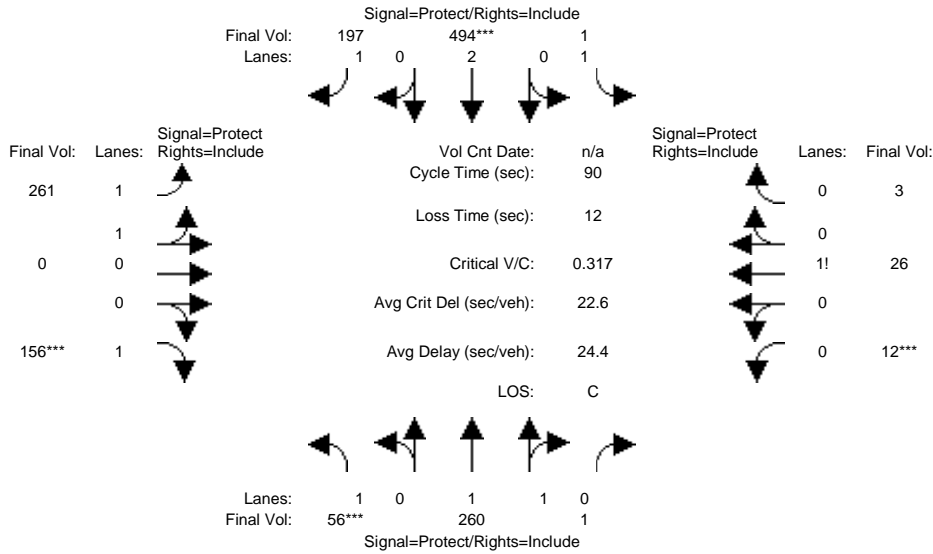

Street Name:	Tantau Avenue						Vallco Parkway					
	North Bound			South Bound			East Bound			West Bound		
Approach:	L	T	R	L	T	R	L	T	R	L	T	R
Min. Green:	7	10	10	7	10	10	7	10	10	7	10	10
Y+R:	4.0	4.0	4.0	4.0	4.0	4.0	4.0	4.0	4.0	4.0	4.0	4.0

Volume Module:												
Base Vol:	49	260	1	1	494	197	261	0	152	12	26	3
Growth Adj:	1.00	1.00	1.00	1.00	1.00	1.00	1.00	1.00	1.00	1.00	1.00	1.00
Initial Bse:	49	260	1	1	494	197	261	0	152	12	26	3
Added Vol:	7	0	0	0	0	0	0	0	4	0	0	0
PasserByVol:	0	0	0	0	0	0	0	0	0	0	0	0
Initial Fut:	56	260	1	1	494	197	261	0	156	12	26	3
User Adj:	1.00	1.00	1.00	1.00	1.00	1.00	1.00	1.00	1.00	1.00	1.00	1.00
PHF Adj:	1.00	1.00	1.00	1.00	1.00	1.00	1.00	1.00	1.00	1.00	1.00	1.00
PHF Volume:	56	260	1	1	494	197	261	0	156	12	26	3
Reduct Vol:	0	0	0	0	0	0	0	0	0	0	0	0
Reduced Vol:	56	260	1	1	494	197	261	0	156	12	26	3
PCE Adj:	1.00	1.00	1.00	1.00	1.00	1.00	1.00	1.00	1.00	1.00	1.00	1.00
MLF Adj:	1.00	1.00	1.00	1.00	1.00	1.00	1.00	1.00	1.00	1.00	1.00	1.00
Final Volume:	56	260	1	1	494	197	261	0	156	12	26	3

Saturation Flow Module:												
Sat/Lane:	1900	1900	1900	1900	1900	1900	1900	1900	1900	1900	1900	1900
Adjustment:	0.92	0.97	0.95	0.92	1.00	0.92	0.93	1.00	0.92	0.92	0.92	0.92
Lanes:	1.00	1.99	0.01	1.00	2.00	1.00	2.00	0.00	1.00	0.29	0.64	0.07
Final Sat.:	1750	3686	14	1750	3800	1750	3550	0	1750	512	1110	128

Capacity Analysis Module:												
Vol/Sat:	0.03	0.07	0.07	0.00	0.13	0.11	0.07	0.00	0.09	0.02	0.02	0.02
Crit Moves:	***			****			****		****	****		
Green Time:	9.0	26.9	26.9	18.9	36.8	36.8	13.3	0.0	25.2	7.0	18.9	18.9
Volume/Cap:	0.32	0.24	0.24	0.00	0.32	0.28	0.50	0.00	0.32	0.30	0.11	0.11
Delay/Veh:	38.7	23.9	23.9	28.1	18.2	18.0	36.1	0.0	26.0	40.4	28.9	28.9
User DelAdj:	1.00	1.00	1.00	1.00	1.00	1.00	1.00	1.00	1.00	1.00	1.00	1.00
AdjDel/Veh:	38.7	23.9	23.9	28.1	18.2	18.0	36.1	0.0	26.0	40.4	28.9	28.9
LOS by Move:	D+	C	C	C	B-	B	D+	A	C	D	C	C
HCM2kAvgQ:	1	3	3	0	5	4	4	0	4	1	1	1

Note: Queue reported is the number of cars per lane.

Hamptons Apartments Complex TIA
 SJ15-1612
 Existing PM

Level Of Service Computation Report
 2000 HCM Operations (Future Volume Alternative)
 Existing PM

Intersection #15: Tantau Avenue / Stevens Creek Boulevard

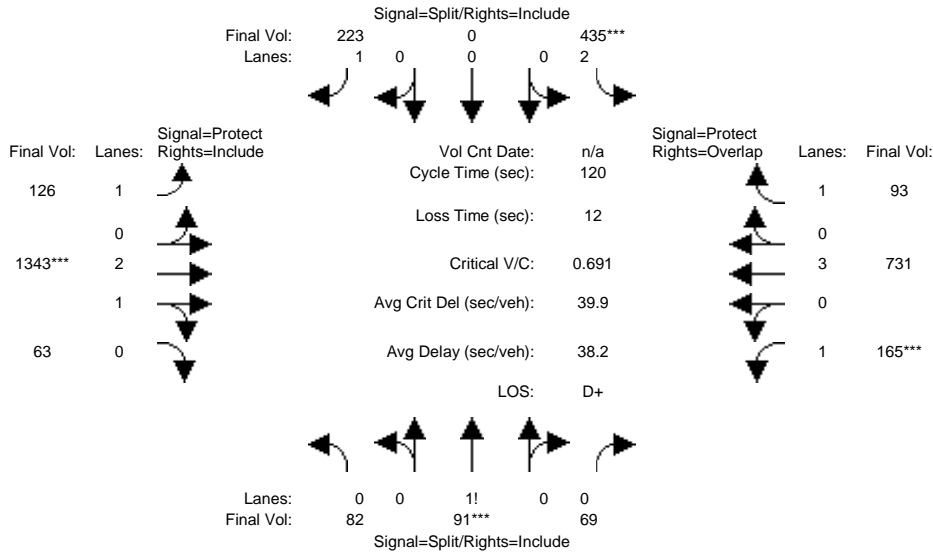

Street Name:	Tantau Avenue						Stevens Creek Boulevard					
	North Bound			South Bound			East Bound			West Bound		
Approach:	North Bound			South Bound			East Bound			West Bound		
Movement:	L	T	R	L	T	R	L	T	R	L	T	R
Min. Green:	10	10	10	10	10	10	7	10	10	7	10	10
Y+R:	4.0	4.0	4.0	4.0	4.0	4.0	4.0	4.0	4.0	4.0	4.0	4.0

Volume Module:												
Base Vol:	82	91	69	435	0	223	126	1343	63	165	731	93
Growth Adj:	1.00	1.00	1.00	1.00	1.00	1.00	1.00	1.00	1.00	1.00	1.00	1.00
Initial Bse:	82	91	69	435	0	223	126	1343	63	165	731	93
Added Vol:	0	0	0	0	0	0	0	0	0	0	0	0
PasserByVol:	0	0	0	0	0	0	0	0	0	0	0	0
Initial Fut:	82	91	69	435	0	223	126	1343	63	165	731	93
User Adj:	1.00	1.00	1.00	1.00	1.00	1.00	1.00	1.00	1.00	1.00	1.00	1.00
PHF Adj:	1.00	1.00	1.00	1.00	1.00	1.00	1.00	1.00	1.00	1.00	1.00	1.00
PHF Volume:	82	91	69	435	0	223	126	1343	63	165	731	93
Reduct Vol:	0	0	0	0	0	0	0	0	0	0	0	0
Reduced Vol:	82	91	69	435	0	223	126	1343	63	165	731	93
PCE Adj:	1.00	1.00	1.00	1.00	1.00	1.00	1.00	1.00	1.00	1.00	1.00	1.00
MLF Adj:	1.00	1.00	1.00	1.00	1.00	1.00	1.00	1.00	1.00	1.00	1.00	1.00
Final Volume:	82	91	69	435	0	223	126	1343	63	165	731	93

Saturation Flow Module:												
Sat/Lane:	1900	1900	1900	1900	1900	1900	1900	1900	1900	1900	1900	1900
Adjustment:	0.92	0.92	0.92	0.83	1.00	0.92	0.92	0.98	0.95	0.92	1.00	0.92
Lanes:	0.34	0.38	0.28	2.00	0.00	1.00	1.00	2.86	0.14	1.00	3.00	1.00
Final Sat.:	593	658	499	3150	0	1750	1750	5349	251	1750	5700	1750

Capacity Analysis Module:												
Vol/Sat:	0.14	0.14	0.14	0.14	0.00	0.13	0.07	0.25	0.25	0.09	0.13	0.05
Crit Moves:	****			****			****			****		
Green Time:	24.0	24.0	24.0	24.0	0.0	24.0	21.6	43.6	43.6	16.4	38.4	62.4
Volume/Cap:	0.69	0.69	0.69	0.69	0.00	0.64	0.40	0.69	0.69	0.69	0.40	0.10
Delay/Veh:	50.3	50.3	50.3	47.8	0.0	47.9	44.3	33.5	33.5	57.7	32.0	14.6
User DelAdj:	1.00	1.00	1.00	1.00	1.00	1.00	1.00	1.00	1.00	1.00	1.00	1.00
AdjDel/Veh:	50.3	50.3	50.3	47.8	0.0	47.9	44.3	33.5	33.5	57.7	32.0	14.6
LOS by Move:	D	D	D	D	A	D	D	C-	C-	E+	C	B
HCM2kAvgQ:	10	10	10	9	0	8	4	15	15	8	7	2

Note: Queue reported is the number of cars per lane.

Hamptons Apartments Complex TIA
 SJ15-1612
 Existing PM

Level Of Service Computation Report
 2000 HCM Operations (Future Volume Alternative)
 Existing PP PM

Intersection #15: Tantau Avenue / Stevens Creek Boulevard

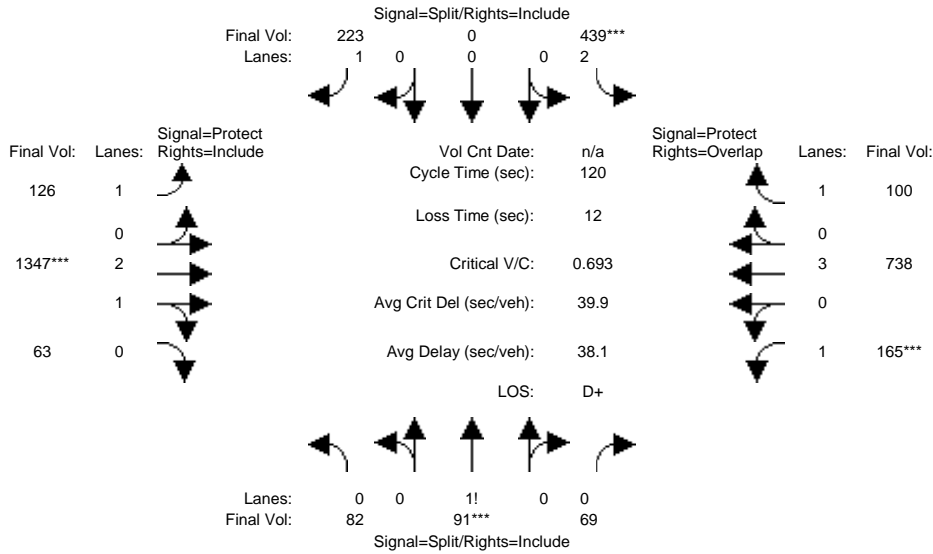

Street Name:	Tantau Avenue						Stevens Creek Boulevard					
	North Bound			South Bound			East Bound			West Bound		
Approach:												
Movement:	L	T	R	L	T	R	L	T	R	L	T	R
Min. Green:	10	10	10	10	10	10	7	10	10	7	10	10
Y+R:	4.0	4.0	4.0	4.0	4.0	4.0	4.0	4.0	4.0	4.0	4.0	4.0

Volume Module:												
Base Vol:	82	91	69	435	0	223	126	1343	63	165	731	93
Growth Adj:	1.00	1.00	1.00	1.00	1.00	1.00	1.00	1.00	1.00	1.00	1.00	1.00
Initial Bse:	82	91	69	435	0	223	126	1343	63	165	731	93
Added Vol:	0	0	0	4	0	0	0	4	0	0	7	7
PasserByVol:	0	0	0	0	0	0	0	0	0	0	0	0
Initial Fut:	82	91	69	439	0	223	126	1347	63	165	738	100
User Adj:	1.00	1.00	1.00	1.00	1.00	1.00	1.00	1.00	1.00	1.00	1.00	1.00
PHF Adj:	1.00	1.00	1.00	1.00	1.00	1.00	1.00	1.00	1.00	1.00	1.00	1.00
PHF Volume:	82	91	69	439	0	223	126	1347	63	165	738	100
Reduct Vol:	0	0	0	0	0	0	0	0	0	0	0	0
Reduced Vol:	82	91	69	439	0	223	126	1347	63	165	738	100
PCE Adj:	1.00	1.00	1.00	1.00	1.00	1.00	1.00	1.00	1.00	1.00	1.00	1.00
MLF Adj:	1.00	1.00	1.00	1.00	1.00	1.00	1.00	1.00	1.00	1.00	1.00	1.00
Final Volume:	82	91	69	439	0	223	126	1347	63	165	738	100

Saturation Flow Module:												
Sat/Lane:	1900	1900	1900	1900	1900	1900	1900	1900	1900	1900	1900	1900
Adjustment:	0.92	0.92	0.92	0.83	1.00	0.92	0.92	0.98	0.95	0.92	1.00	0.92
Lanes:	0.34	0.38	0.28	2.00	0.00	1.00	1.00	2.86	0.14	1.00	3.00	1.00
Final Sat.:	593	658	499	3150	0	1750	1750	5349	250	1750	5700	1750

Capacity Analysis Module:												
Vol/Sat:	0.14	0.14	0.14	0.14	0.00	0.13	0.07	0.25	0.25	0.09	0.13	0.06
Crit Moves:	****			****			****			****		
Green Time:	23.9	23.9	23.9	24.1	0.0	24.1	21.4	43.6	43.6	16.3	38.5	62.6
Volume/Cap:	0.69	0.69	0.69	0.69	0.00	0.63	0.40	0.69	0.69	0.69	0.40	0.11
Delay/Veh:	50.5	50.5	50.5	47.8	0.0	47.6	44.5	33.6	33.6	58.0	31.9	14.6
User DelAdj:	1.00	1.00	1.00	1.00	1.00	1.00	1.00	1.00	1.00	1.00	1.00	1.00
AdjDel/Veh:	50.5	50.5	50.5	47.8	0.0	47.6	44.5	33.6	33.6	58.0	31.9	14.6
LOS by Move:	D	D	D	D	A	D	D	C-	C-	E+	C	B
HCM2kAvgQ:	10	10	10	9	0	8	4	15	15	8	7	2

Note: Queue reported is the number of cars per lane.

Hamptons Apartments Complex TIA
 SJ15-1612
 Existing PM

Level Of Service Computation Report
 2000 HCM Operations (Future Volume Alternative)
 Existing PM

Intersection #16: Lawrence Expressway / Homestead Road

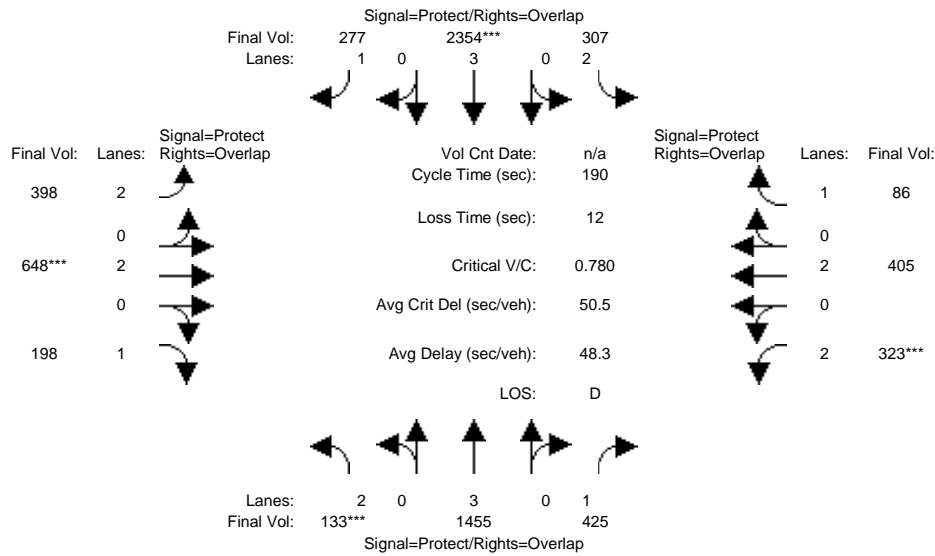

Street Name:	Lawrence Expressway						Homestead Road					
	North Bound			South Bound			East Bound			West Bound		
Approach:	North Bound			South Bound			East Bound			West Bound		
Movement:	L	T	R	L	T	R	L	T	R	L	T	R
Min. Green:	14	85	10	14	107	10	14	10	10	14	10	10
Y+R:	4.0	4.0	4.0	4.0	4.0	4.0	4.0	4.0	4.0	4.0	4.0	4.0

Volume Module:												
Base Vol:	133	1842	425	307	2980	277	398	648	198	323	405	86
Growth Adj:	1.00	1.00	1.00	1.00	1.00	1.00	1.00	1.00	1.00	1.00	1.00	1.00
Initial Bse:	133	1842	425	307	2980	277	398	648	198	323	405	86
Added Vol:	0	0	0	0	0	0	0	0	0	0	0	0
PasserByVol:	0	0	0	0	0	0	0	0	0	0	0	0
Initial Fut:	133	1842	425	307	2980	277	398	648	198	323	405	86
User Adj:	1.00	0.79	1.00	1.00	0.79	1.00	1.00	1.00	1.00	1.00	1.00	1.00
PHF Adj:	1.00	1.00	1.00	1.00	1.00	1.00	1.00	1.00	1.00	1.00	1.00	1.00
PHF Volume:	133	1455	425	307	2354	277	398	648	198	323	405	86
Reduct Vol:	0	0	0	0	0	0	0	0	0	0	0	0
Reduced Vol:	133	1455	425	307	2354	277	398	648	198	323	405	86
PCE Adj:	1.00	1.00	1.00	1.00	1.00	1.00	1.00	1.00	1.00	1.00	1.00	1.00
MLF Adj:	1.00	1.00	1.00	1.00	1.00	1.00	1.00	1.00	1.00	1.00	1.00	1.00
Final Volume:	133	1455	425	307	2354	277	398	648	198	323	405	86

Saturation Flow Module:												
Sat/Lane:	1900	1900	1900	1900	1900	1900	1900	1900	1900	1900	1900	1900
Adjustment:	0.83	1.00	0.92	0.83	1.00	0.92	0.83	1.00	0.92	0.83	1.00	0.92
Lanes:	2.00	3.00	1.00	2.00	3.00	1.00	2.00	2.00	1.00	2.00	2.00	1.00
Final Sat.:	3150	5700	1750	3150	5700	1750	3150	3800	1750	3150	3800	1750

Capacity Analysis Module:												
Vol/Sat:	0.04	0.26	0.24	0.10	0.41	0.16	0.13	0.17	0.11	0.10	0.11	0.05
Crit Moves:	***			****			****			****		
Green Time:	14.8	106	124.5	21.9	113	139.9	26.9	31.0	45.8	18.6	22.7	44.6
Volume/Cap:	0.54	0.46	0.37	0.85	0.69	0.22	0.89	1.05	0.47	1.05	0.89	0.21
Delay/Veh:	82.4	23.8	14.3	94.9	15.5	0.7	95.5	124	59.3	144.9	97.5	55.7
User DelAdj:	1.00	1.00	1.00	1.00	1.00	1.00	1.00	1.00	1.00	1.00	1.00	1.00
AdjDel/Veh:	82.4	23.8	14.3	94.9	15.5	0.7	95.5	124	59.3	144.9	97.5	55.7
LOS by Move:	F	C	B	F	B	A	F	F	E+	F	F	E+
HCM2kAvgQ:	5	15	11	12	20	1	13	20	11	15	14	5

Note: Queue reported is the number of cars per lane.

Hamptons Apartments Complex TIA
 SJ15-1612
 Existing PM

Level Of Service Computation Report
 2000 HCM Operations (Future Volume Alternative)
 Existing PP PM

Intersection #16: Lawrence Expressway / Homestead Road

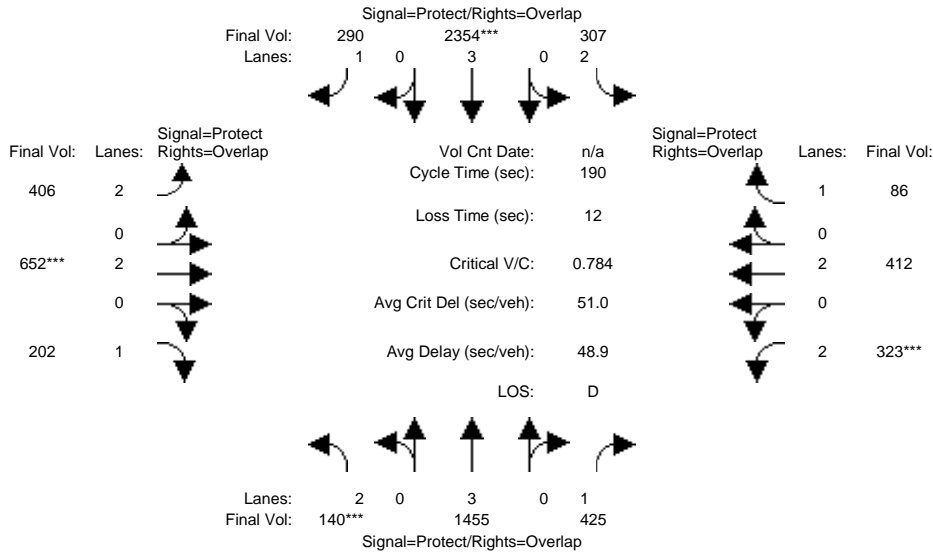

Street Name:	Lawrence Expressway						Homestead Road					
	North Bound			South Bound			East Bound			West Bound		
Approach:	North Bound			South Bound			East Bound			West Bound		
Movement:	L	T	R	L	T	R	L	T	R	L	T	R
Min. Green:	14	85	10	14	107	10	14	10	10	14	10	10
Y+R:	4.0	4.0	4.0	4.0	4.0	4.0	4.0	4.0	4.0	4.0	4.0	4.0

Volume Module:												
Base Vol:	133	1842	425	307	2980	277	398	648	198	323	405	86
Growth Adj:	1.00	1.00	1.00	1.00	1.00	1.00	1.00	1.00	1.00	1.00	1.00	1.00
Initial Bse:	133	1842	425	307	2980	277	398	648	198	323	405	86
Added Vol:	7	0	0	0	0	13	8	4	4	0	7	0
PasserByVol:	0	0	0	0	0	0	0	0	0	0	0	0
Initial Fut:	140	1842	425	307	2980	290	406	652	202	323	412	86
User Adj:	1.00	0.79	1.00	1.00	0.79	1.00	1.00	1.00	1.00	1.00	1.00	1.00
PHF Adj:	1.00	1.00	1.00	1.00	1.00	1.00	1.00	1.00	1.00	1.00	1.00	1.00
PHF Volume:	140	1455	425	307	2354	290	406	652	202	323	412	86
Reduct Vol:	0	0	0	0	0	0	0	0	0	0	0	0
Reduced Vol:	140	1455	425	307	2354	290	406	652	202	323	412	86
PCE Adj:	1.00	1.00	1.00	1.00	1.00	1.00	1.00	1.00	1.00	1.00	1.00	1.00
MLF Adj:	1.00	1.00	1.00	1.00	1.00	1.00	1.00	1.00	1.00	1.00	1.00	1.00
Final Volume:	140	1455	425	307	2354	290	406	652	202	323	412	86

Saturation Flow Module:												
Sat/Lane:	1900	1900	1900	1900	1900	1900	1900	1900	1900	1900	1900	1900
Adjustment:	0.83	1.00	0.92	0.83	1.00	0.92	0.83	1.00	0.92	0.83	1.00	0.92
Lanes:	2.00	3.00	1.00	2.00	3.00	1.00	2.00	2.00	1.00	2.00	2.00	1.00
Final Sat.:	3150	5700	1750	3150	5700	1750	3150	3800	1750	3150	3800	1750

Capacity Analysis Module:												
Vol/Sat:	0.04	0.26	0.24	0.10	0.41	0.17	0.13	0.17	0.12	0.10	0.11	0.05
Crit Moves:	***			****			****			****		
Green Time:	14.8	106	124.4	21.9	113	139.9	26.9	31.1	45.8	18.6	22.7	44.5
Volume/Cap:	0.57	0.46	0.37	0.85	0.69	0.23	0.91	1.05	0.48	1.05	0.91	0.21
Delay/Veh:	83.3	23.8	14.4	94.9	15.5	0.7	98.3	125	59.4	146.2	100	55.8
User DelAdj:	1.00	1.00	1.00	1.00	1.00	1.00	1.00	1.00	1.00	1.00	1.00	1.00
AdjDel/Veh:	83.3	23.8	14.4	94.9	15.5	0.7	98.3	125	59.4	146.2	100	55.8
LOS by Move:	F	C	B	F	B	A	F	F	E+	F	F	E+
HCM2kAvgQ:	5	15	11	12	20	1	13	20	11	15	14	5

Note: Queue reported is the number of cars per lane.

Hamptons Apartment Complex TIA
 SJ15-1612
 Background AM / Background PP AM

Summary Scenario Comparison Report (With Average Critical Delay)
 Future Volume Alternative

Intersection	???				Background AM				Background PP AM					???				
	LOS	Avg Del (sec)	Crit V/C	Avg Crit Del (sec)	LOS	Avg Del (sec)	Crit V/C	Avg Crit Del (sec)	LOS	Avg Del (sec)	Crit V/C	Crit V/C Change	Avg Crit Del (sec)	Avg Crit Del Change	LOS	Avg Del (sec)	Crit V/C	Avg Crit Del (sec)
#1 Wolfe Road / El Camino Real	?	xx.x	x.xxx	xx.x	D+	35.7	0.669	33.0	D+	35.7	0.671	+ 0.002	33.0	+ 0.0	?	xx.x	x.xxx	xx.x
#2 Wolfe Road / Fremont Avenue	?	xx.x	x.xxx	xx.x	C-	35.0	0.708	40.3	D+	35.2	0.714	+ 0.006	40.3	+ 0.1	?	xx.x	x.xxx	xx.x
#3 Wolfe Road / Marion Way	?	xx.x	x.xxx	xx.x	B	14.3	0.536	18.9	B	14.2	0.546	+ 0.010	18.8	- 0.2	?	xx.x	x.xxx	xx.x
#4 Wolfe Road / Inverness Avenue	?	xx.x	x.xxx	xx.x	C	24.5	0.508	24.6	C	24.2	0.518	+ 0.010	24.3	- 0.2	?	xx.x	x.xxx	xx.x
#5 Wolfe Road / Homestead Road	?	xx.x	x.xxx	xx.x	C	31.5	0.782	33.0	C	31.5	0.790	+ 0.007	32.7	- 0.3	?	xx.x	x.xxx	xx.x
#6 Wolfe Road / Apple Campus 2	?	xx.x	x.xxx	xx.x	B	15.6	0.734	25.6	B	15.6	0.734	+ 0.000	25.6	+ 0.0	?	xx.x	x.xxx	xx.x
#7 Wolfe Road / Pruneridge Avenue	?	xx.x	x.xxx	xx.x	B	14.3	0.481	12.5	C+	22.4	0.588	+ 0.107	21.2	+ 8.7	?	xx.x	x.xxx	xx.x
#8 Wolfe Road / I-280 NB Ramps	?	xx.x	x.xxx	xx.x	C	26.0	0.789	28.0	C	26.3	0.797	+ 0.008	28.3	+ 0.3	?	xx.x	x.xxx	xx.x
#9 Wolfe Road / I-280 SB Ramps	?	xx.x	x.xxx	xx.x	C	29.6	0.877	34.9	C	29.8	0.884	+ 0.007	35.4	+ 0.6	?	xx.x	x.xxx	xx.x
#10 Wolfe Road / Vallco Parkway	?	xx.x	x.xxx	xx.x	C	28.5	0.689	34.9	C	28.5	0.692	+ 0.004	35.0	+ 0.2	?	xx.x	x.xxx	xx.x
#11 Wolfe Road / Stevens Creek Boulevard	?	xx.x	x.xxx	xx.x	D	48.3	0.900	53.9	D	48.9	0.906	+ 0.006	54.7	+ 0.8	?	xx.x	x.xxx	xx.x
#12 De Anza Boulevard / Stevens Creek Boulevard	?	xx.x	x.xxx	xx.x	D+	37.7	0.896	42.0	D+	37.8	0.896	+ 0.000	42.1	+ 0.0	?	xx.x	x.xxx	xx.x
#13 Tantau Avenue / Homestead Road	?	xx.x	x.xxx	xx.x	D	39.4	0.934	55.7	D	40.2	0.941	+ 0.007	57.2	+ 1.5	?	xx.x	x.xxx	xx.x
#14 Tantau Avenue / Vallco Parkway	?	xx.x	x.xxx	xx.x	C	27.5	0.650	28.4	C	27.5	0.650	+ 0.000	28.4	+ 0.0	?	xx.x	x.xxx	xx.x
#15 Tantau Avenue / Stevens Creek Boulevard	?	xx.x	x.xxx	xx.x	F	82.8	1.203	148.7	F	83.0	1.203	+ 0.001	149.0	+ 0.3	?	xx.x	x.xxx	xx.x
#16 Lawrence Expressway / Homestead Road	?	xx.x	x.xxx	xx.x	F	110.7	0.861	149.4	F	110.7	0.863	+ 0.002	149.3	- 0.1	?	xx.x	x.xxx	xx.x

Hamptons Apartment Complex TIA
 SJ15-1612
 Background AM

Level Of Service Computation Report
 2000 HCM Operations (Future Volume Alternative)
 Background AM

Intersection #0:

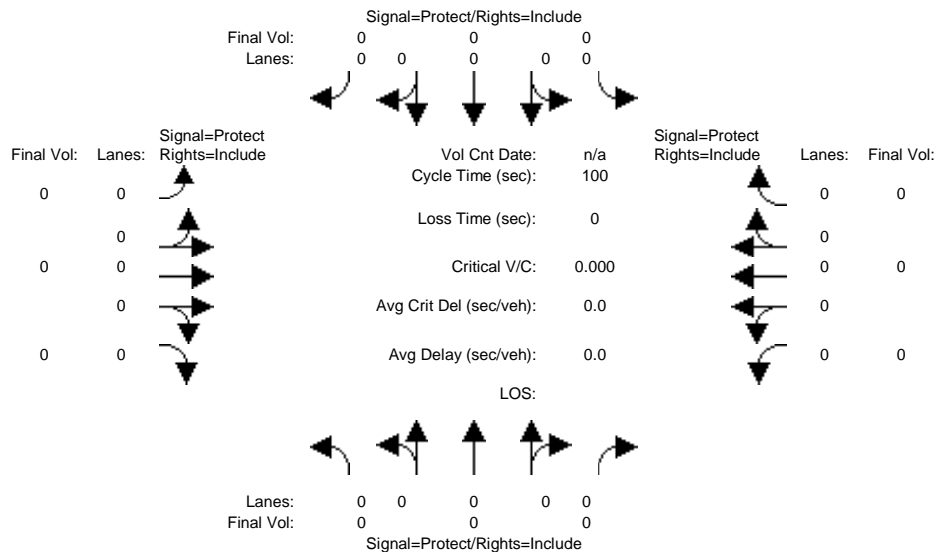

Approach:	North Bound			South Bound			East Bound			West Bound		
Movement:	L	T	R	L	T	R	L	T	R	L	T	R
Min. Green:	7	10	10	7	10	10	7	10	10	7	10	10
Y+R:	4.0	4.0	4.0	4.0	4.0	4.0	4.0	4.0	4.0	4.0	4.0	4.0

Volume Module:	North Bound			South Bound			East Bound			West Bound		
Base Vol:	0	0	0	0	0	0	0	0	0	0	0	0
Growth Adj:	0.00	0.00	0.00	0.00	0.00	0.00	0.00	0.00	0.00	0.00	0.00	0.00
Initial Bse:	0	0	0	0	0	0	0	0	0	0	0	0
Added Vol:	0	0	0	0	0	0	0	0	0	0	0	0
PasserByVol:	0	0	0	0	0	0	0	0	0	0	0	0
Initial Fut:	0	0	0	0	0	0	0	0	0	0	0	0
User Adj:	0.00	0.00	0.00	0.00	0.00	0.00	0.00	0.00	0.00	0.00	0.00	0.00
PHF Adj:	0.00	0.00	0.00	0.00	0.00	0.00	0.00	0.00	0.00	0.00	0.00	0.00
PHF Volume:	0	0	0	0	0	0	0	0	0	0	0	0
Reduct Vol:	0	0	0	0	0	0	0	0	0	0	0	0
Reduced Vol:	0	0	0	0	0	0	0	0	0	0	0	0
PCE Adj:	0.00	0.00	0.00	0.00	0.00	0.00	0.00	0.00	0.00	0.00	0.00	0.00
MLF Adj:	0.00	0.00	0.00	0.00	0.00	0.00	0.00	0.00	0.00	0.00	0.00	0.00
Final Volume:	0	0	0	0	0	0	0	0	0	0	0	0

Saturation Flow Module:	North Bound			South Bound			East Bound			West Bound		
Sat/Lane:	0	0	0	0	0	0	0	0	0	0	0	0
Adjustment:	1.00	1.00	1.00	1.00	1.00	1.00	1.00	1.00	1.00	1.00	1.00	1.00
Lanes:	0.00	0.00	0.00	0.00	0.00	0.00	0.00	0.00	0.00	0.00	0.00	0.00
Final Sat.:	0	0	0	0	0	0	0	0	0	0	0	0

Capacity Analysis Module:	North Bound			South Bound			East Bound			West Bound		
Vol/Sat:	0.00	0.00	0.00	0.00	0.00	0.00	0.00	0.00	0.00	0.00	0.00	0.00
Crit Moves:												
Green Time:	0.0	0.0	0.0	0.0	0.0	0.0	0.0	0.0	0.0	0.0	0.0	0.0
Volume/Cap:	0.00	0.00	0.00	0.00	0.00	0.00	0.00	0.00	0.00	0.00	0.00	0.00
Delay/Veh:	0.0	0.0	0.0	0.0	0.0	0.0	0.0	0.0	0.0	0.0	0.0	0.0
User DelAdj:	1.00	1.00	1.00	1.00	1.00	1.00	1.00	1.00	1.00	1.00	1.00	1.00
AdjDel/Veh:	0.0	0.0	0.0	0.0	0.0	0.0	0.0	0.0	0.0	0.0	0.0	0.0
LOS by Move:												
HCM2kAvgQ:	0	0	0	0	0	0	0	0	0	0	0	0

Note: Queue reported is the number of cars per lane.

Hamptons Apartment Complex TIA
SJ15-1612
Background AM

Level Of Service Computation Report
2000 HCM Operations (Future Volume Alternative)
Background PP AM

Intersection #0:

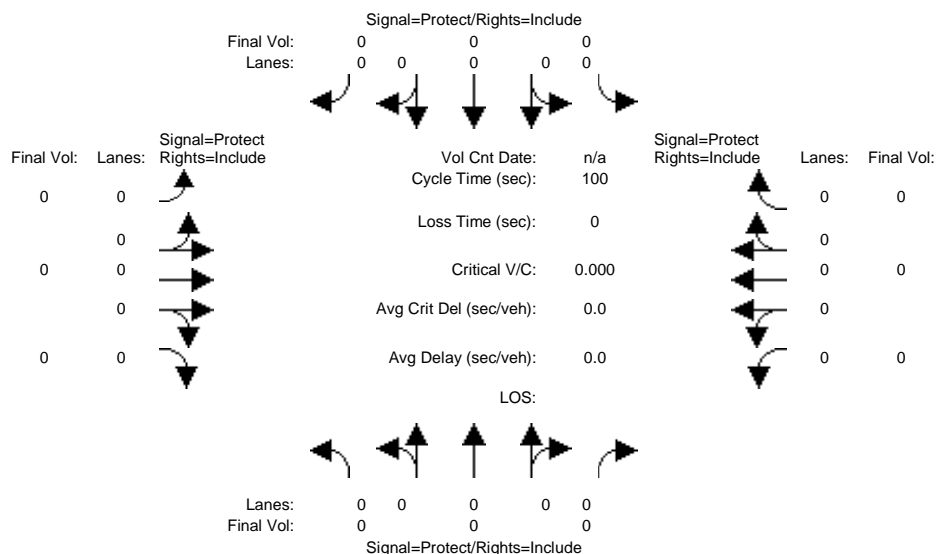

Approach:	North Bound			South Bound			East Bound			West Bound		
	L	T	R	L	T	R	L	T	R	L	T	R
Min. Green:	7	10	10	7	10	10	7	10	10	7	10	10
Y+R:	4.0	4.0	4.0	4.0	4.0	4.0	4.0	4.0	4.0	4.0	4.0	4.0

Volume Module:

Base Vol:	0	0	0	0	0	0	0	0	0	0	0	0
Growth Adj:	0.00	0.00	0.00	0.00	0.00	0.00	0.00	0.00	0.00	0.00	0.00	0.00
Initial Bse:	0	0	0	0	0	0	0	0	0	0	0	0
Added Vol:	0	0	0	0	0	0	0	0	0	0	0	0
PasserByVol:	0	0	0	0	0	0	0	0	0	0	0	0
Initial Fut:	0	0	0	0	0	0	0	0	0	0	0	0
User Adj:	0.00	0.00	0.00	0.00	0.00	0.00	0.00	0.00	0.00	0.00	0.00	0.00
PHF Adj:	0.00	0.00	0.00	0.00	0.00	0.00	0.00	0.00	0.00	0.00	0.00	0.00
PHF Volume:	0	0	0	0	0	0	0	0	0	0	0	0
Reduct Vol:	0	0	0	0	0	0	0	0	0	0	0	0
Reduced Vol:	0	0	0	0	0	0	0	0	0	0	0	0
PCE Adj:	0.00	0.00	0.00	0.00	0.00	0.00	0.00	0.00	0.00	0.00	0.00	0.00
MLF Adj:	0.00	0.00	0.00	0.00	0.00	0.00	0.00	0.00	0.00	0.00	0.00	0.00
FinalVolume:	0	0	0	0	0	0	0	0	0	0	0	0

Saturation Flow Module:

Sat/Lane:	0	0	0	0	0	0	0	0	0	0	0	0
Adjustment:	1.00	1.00	1.00	1.00	1.00	1.00	1.00	1.00	1.00	1.00	1.00	1.00
Lanes:	0.00	0.00	0.00	0.00	0.00	0.00	0.00	0.00	0.00	0.00	0.00	0.00
Final Sat.:	0	0	0	0	0	0	0	0	0	0	0	0

Capacity Analysis Module:

Vol/Sat:	0.00	0.00	0.00	0.00	0.00	0.00	0.00	0.00	0.00	0.00	0.00	0.00
Crit Moves:												
Green Time:	0.0	0.0	0.0	0.0	0.0	0.0	0.0	0.0	0.0	0.0	0.0	0.0
Volume/Cap:	0.00	0.00	0.00	0.00	0.00	0.00	0.00	0.00	0.00	0.00	0.00	0.00
Delay/Veh:	0.0	0.0	0.0	0.0	0.0	0.0	0.0	0.0	0.0	0.0	0.0	0.0
User DelAdj:	1.00	1.00	1.00	1.00	1.00	1.00	1.00	1.00	1.00	1.00	1.00	1.00
AdjDel/Veh:	0.0	0.0	0.0	0.0	0.0	0.0	0.0	0.0	0.0	0.0	0.0	0.0
LOS by Move:												
HCM2kAvgQ:	0	0	0	0	0	0	0	0	0	0	0	0

Note: Queue reported is the number of cars per lane.

Hamptons Apartment Complex TIA
SJ15-1612
Background AM

Level Of Service Computation Report
2000 HCM Operations (Future Volume Alternative)
Background AM

Intersection #1: Wolfe Road / El Camino Real

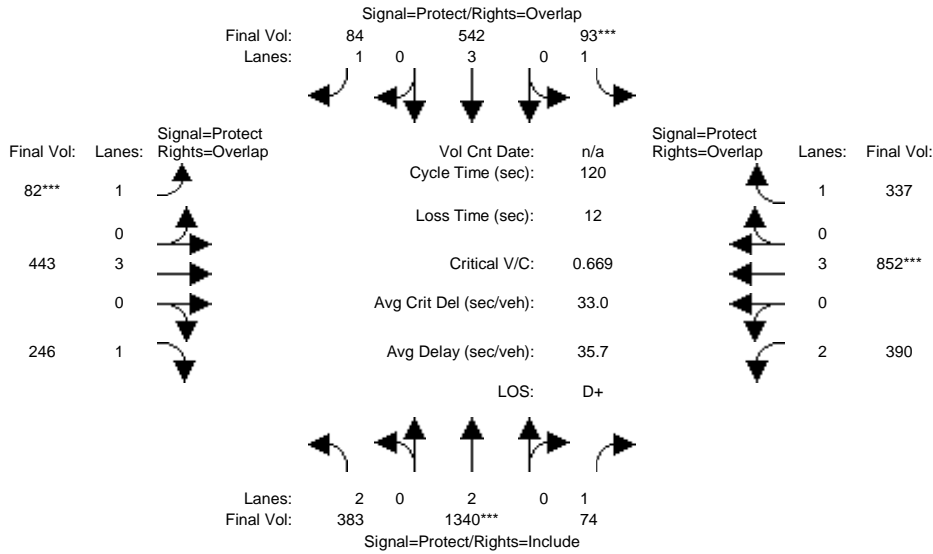

Street Name:	Wolfe Road						El Camino Real					
	North Bound			South Bound			East Bound			West Bound		
Approach:	North Bound			South Bound			East Bound			West Bound		
Movement:	L	T	R	L	T	R	L	T	R	L	T	R
Min. Green:	7	10	10	7	10	10	7	10	10	7	10	10
Y+R:	4.0	4.0	4.0	4.0	4.0	4.0	4.0	4.0	4.0	4.0	4.0	4.0

Volume Module:												
Base Vol:	367	1324	46	89	477	84	82	413	166	339	758	327
Growth Adj:	1.00	1.00	1.00	1.00	1.00	1.00	1.00	1.00	1.00	1.00	1.00	1.00
Initial Bse:	367	1324	46	89	477	84	82	413	166	339	758	327
Added Vol:	0	0	0	0	0	0	0	0	0	0	0	0
PasserByVol:	16	16	28	4	65	0	0	30	80	51	94	10
Initial Fut:	383	1340	74	93	542	84	82	443	246	390	852	337
User Adj:	1.00	1.00	1.00	1.00	1.00	1.00	1.00	1.00	1.00	1.00	1.00	1.00
PHF Adj:	1.00	1.00	1.00	1.00	1.00	1.00	1.00	1.00	1.00	1.00	1.00	1.00
PHF Volume:	383	1340	74	93	542	84	82	443	246	390	852	337
Reduct Vol:	0	0	0	0	0	0	0	0	0	0	0	0
Reduced Vol:	383	1340	74	93	542	84	82	443	246	390	852	337
PCE Adj:	1.00	1.00	1.00	1.00	1.00	1.00	1.00	1.00	1.00	1.00	1.00	1.00
MLF Adj:	1.00	1.00	1.00	1.00	1.00	1.00	1.00	1.00	1.00	1.00	1.00	1.00
Final Volume:	383	1340	74	93	542	84	82	443	246	390	852	337

Saturation Flow Module:												
Sat/Lane:	1900	1900	1900	1900	1900	1900	1900	1900	1900	1900	1900	1900
Adjustment:	0.83	1.00	0.92	0.92	1.00	0.92	0.92	1.00	0.92	0.83	1.00	0.92
Lanes:	2.00	2.00	1.00	1.00	3.00	1.00	1.00	3.00	1.00	2.00	3.00	1.00
Final Sat.:	3150	3800	1750	1750	5700	1750	1750	5700	1750	3150	5700	1750

Capacity Analysis Module:												
Vol/Sat:	0.12	0.35	0.04	0.05	0.10	0.05	0.05	0.08	0.14	0.12	0.15	0.19
Crit Moves:	****			****			****			****		
Green Time:	40.8	63.3	63.3	9.5	31.9	40.3	8.4	14.2	55.0	21.0	26.8	36.3
Volume/Cap:	0.36	0.67	0.08	0.67	0.36	0.14	0.67	0.66	0.31	0.71	0.67	0.64
Delay/Veh:	29.9	21.6	14.0	65.6	35.8	27.9	67.8	53.0	20.7	50.7	43.9	38.7
User DelAdj:	1.00	1.00	1.00	1.00	1.00	1.00	1.00	1.00	1.00	1.00	1.00	1.00
AdjDel/Veh:	29.9	21.6	14.0	65.6	35.8	27.9	67.8	53.0	20.7	50.7	43.9	38.7
LOS by Move:	C	C+	B	E	D+	C	E	D-	C+	D	D	D+
HCM2kAvgQ:	6	17	1	5	5	2	4	6	6	9	10	12

Note: Queue reported is the number of cars per lane.

Hamptons Apartment Complex TIA
SJ15-1612
Background AM

Level Of Service Computation Report
2000 HCM Operations (Future Volume Alternative)
Background PP AM

Intersection #1: Wolfe Road / El Camino Real

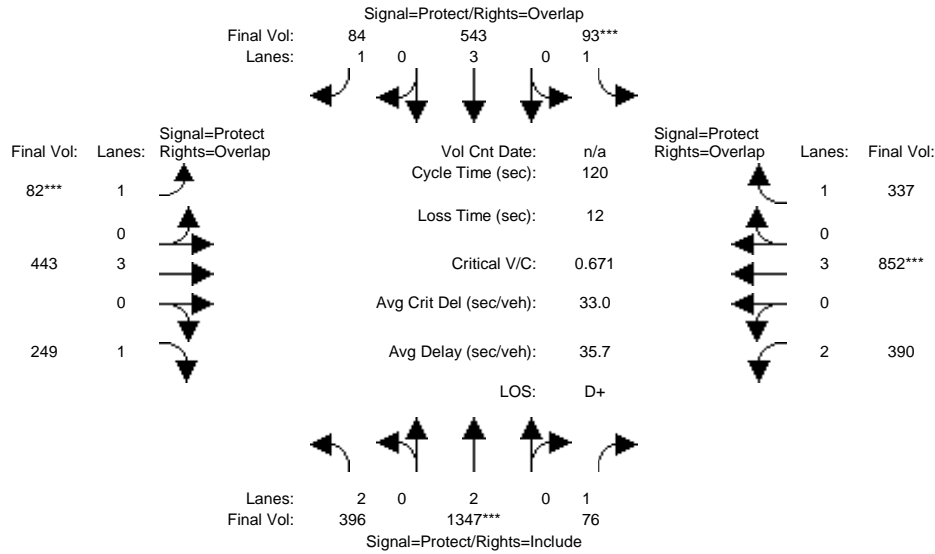

Street Name:	Wolfe Road						El Camino Real					
	North Bound			South Bound			East Bound			West Bound		
Approach:	North Bound			South Bound			East Bound			West Bound		
Movement:	L	T	R	L	T	R	L	T	R	L	T	R
Min. Green:	7	10	10	7	10	10	7	10	10	7	10	10
Y+R:	4.0	4.0	4.0	4.0	4.0	4.0	4.0	4.0	4.0	4.0	4.0	4.0

Volume Module:												
Base Vol:	367	1324	46	89	477	84	82	413	166	339	758	327
Growth Adj:	1.00	1.00	1.00	1.00	1.00	1.00	1.00	1.00	1.00	1.00	1.00	1.00
Initial Bse:	367	1324	46	89	477	84	82	413	166	339	758	327
Added Vol:	13	7	2	0	1	0	0	0	3	0	0	0
PasserByVol:	16	16	28	4	65	0	0	30	80	51	94	10
Initial Fut:	396	1347	76	93	543	84	82	443	249	390	852	337
User Adj:	1.00	1.00	1.00	1.00	1.00	1.00	1.00	1.00	1.00	1.00	1.00	1.00
PHF Adj:	1.00	1.00	1.00	1.00	1.00	1.00	1.00	1.00	1.00	1.00	1.00	1.00
PHF Volume:	396	1347	76	93	543	84	82	443	249	390	852	337
Reduct Vol:	0	0	0	0	0	0	0	0	0	0	0	0
Reduced Vol:	396	1347	76	93	543	84	82	443	249	390	852	337
PCE Adj:	1.00	1.00	1.00	1.00	1.00	1.00	1.00	1.00	1.00	1.00	1.00	1.00
MLF Adj:	1.00	1.00	1.00	1.00	1.00	1.00	1.00	1.00	1.00	1.00	1.00	1.00
Final Volume:	396	1347	76	93	543	84	82	443	249	390	852	337

Saturation Flow Module:												
Sat/Lane:	1900	1900	1900	1900	1900	1900	1900	1900	1900	1900	1900	1900
Adjustment:	0.83	1.00	0.92	0.92	1.00	0.92	0.92	1.00	0.92	0.83	1.00	0.92
Lanes:	2.00	2.00	1.00	1.00	3.00	1.00	1.00	3.00	1.00	2.00	3.00	1.00
Final Sat.:	3150	3800	1750	1750	5700	1750	1750	5700	1750	3150	5700	1750

Capacity Analysis Module:												
Vol/Sat:	0.13	0.35	0.04	0.05	0.10	0.05	0.05	0.08	0.14	0.12	0.15	0.19
Crit Moves:	****			****			****			****		
Green Time:	41.5	63.4	63.4	9.5	31.4	39.8	8.4	14.1	55.6	21.0	26.7	36.2
Volume/Cap:	0.36	0.67	0.08	0.67	0.36	0.14	0.67	0.66	0.31	0.71	0.67	0.64
Delay/Veh:	29.6	21.6	14.0	65.8	36.3	28.3	68.1	53.1	20.4	50.9	44.0	38.8
User DelAdj:	1.00	1.00	1.00	1.00	1.00	1.00	1.00	1.00	1.00	1.00	1.00	1.00
AdjDel/Veh:	29.6	21.6	14.0	65.8	36.3	28.3	68.1	53.1	20.4	50.9	44.0	38.8
LOS by Move:	C	C+	B	E	D+	C	E	D-	C+	D	D	D+
HCM2kAvgQ:	6	17	1	5	5	2	4	6	6	9	10	12

Note: Queue reported is the number of cars per lane.

Hamptons Apartment Complex TIA
SJ15-1612
Background AM

Level Of Service Computation Report
2000 HCM Operations (Future Volume Alternative)
Background AM

Intersection #2: Wolfe Road / Fremont Avenue

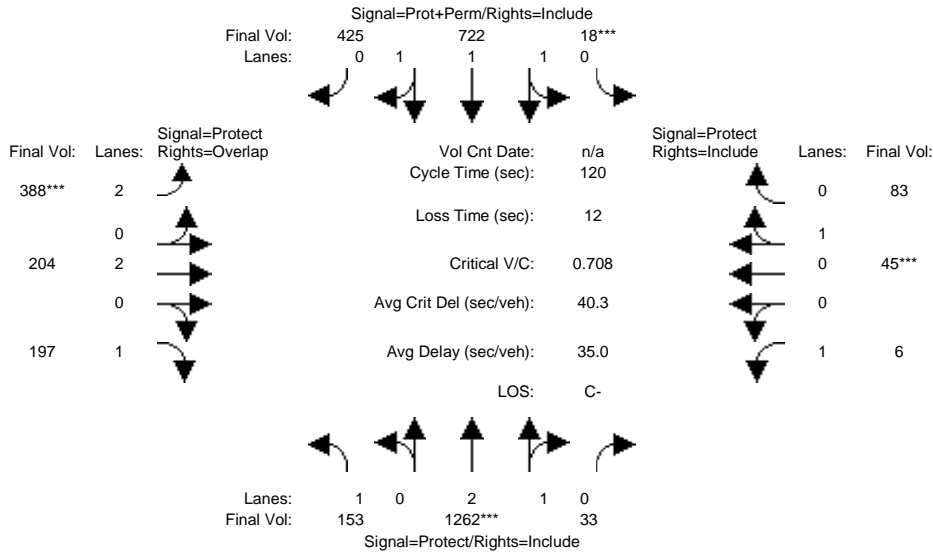

Street Name:	Wolfe Road						Fremont Avenue					
	North Bound			South Bound			East Bound			West Bound		
Approach:	L	T	R	L	T	R	L	T	R	L	T	R
Min. Green:	7	10	10	7	10	10	7	10	10	7	10	10
Y+R:	4.0	4.0	4.0	4.0	4.0	4.0	4.0	4.0	4.0	4.0	4.0	4.0

Volume Module:												
Base Vol:	144	1206	31	18	547	425	388	204	146	4	45	83
Growth Adj:	1.00	1.00	1.00	1.00	1.00	1.00	1.00	1.00	1.00	1.00	1.00	1.00
Initial Bse:	144	1206	31	18	547	425	388	204	146	4	45	83
Added Vol:	0	0	0	0	0	0	0	0	0	0	0	0
PasserByVol:	9	56	2	0	175	0	0	0	51	2	0	0
Initial Fut:	153	1262	33	18	722	425	388	204	197	6	45	83
User Adj:	1.00	1.00	1.00	1.00	1.00	1.00	1.00	1.00	1.00	1.00	1.00	1.00
PHF Adj:	1.00	1.00	1.00	1.00	1.00	1.00	1.00	1.00	1.00	1.00	1.00	1.00
PHF Volume:	153	1262	33	18	722	425	388	204	197	6	45	83
Reduct Vol:	0	0	0	0	0	0	0	0	0	0	0	0
Reduced Vol:	153	1262	33	18	722	425	388	204	197	6	45	83
PCE Adj:	1.00	1.00	1.00	1.00	1.00	1.00	1.00	1.00	1.00	1.00	1.00	1.00
MLF Adj:	1.00	1.00	1.00	1.00	1.00	1.00	1.00	1.00	1.00	1.00	1.00	1.00
Final Volume:	153	1262	33	18	722	425	388	204	197	6	45	83

Saturation Flow Module:												
Sat/Lane:	1900	1900	1900	1900	1900	1900	1900	1900	1900	1900	1900	1900
Adjustment:	0.92	0.98	0.95	0.95	0.98	0.95	0.83	1.00	0.92	0.92	0.95	0.95
Lanes:	1.00	2.92	0.08	0.05	1.95	1.00	2.00	2.00	1.00	1.00	0.35	0.65
Final Sat.:	1750	5457	143	90	3615	1800	3150	3800	1750	1750	633	1167

Capacity Analysis Module:												
Vol/Sat:	0.09	0.23	0.23	0.00	0.20	0.24	0.12	0.05	0.11	0.00	0.07	0.07
Crit Moves:	****			****			****			****		
Green Time:	20.1	39.9	39.9	34.5	54.3	54.3	21.3	19.7	39.9	13.8	12.3	12.3
Volume/Cap:	0.52	0.69	0.69	0.69	0.44	0.52	0.69	0.33	0.34	0.03	0.69	0.69
Delay/Veh:	47.2	35.9	35.9	39.3	22.6	23.7	50.1	44.6	30.5	47.2	63.0	63.0
User DelAdj:	1.00	1.00	1.00	1.00	1.00	1.00	1.00	1.00	1.00	1.00	1.00	1.00
AdjDel/Veh:	47.2	35.9	35.9	39.3	22.6	23.7	50.1	44.6	30.5	47.2	63.0	63.0
LOS by Move:	D	D+	D+	D	C+	C	D	D	C	D	E	E
HCM2kAvgQ:	5	14	14	12	9	11	9	3	6	0	6	6

Note: Queue reported is the number of cars per lane.

Hamptons Apartment Complex TIA
SJ15-1612
Background AM

Level Of Service Computation Report
2000 HCM Operations (Future Volume Alternative)
Background PP AM

Intersection #2: Wolfe Road / Fremont Avenue

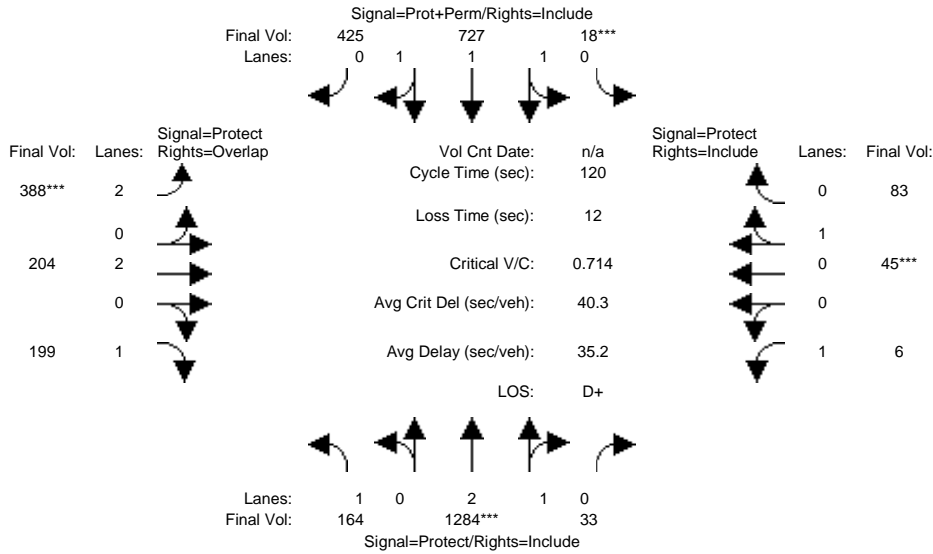

Street Name:	Wolfe Road						Fremont Avenue					
	North Bound			South Bound			East Bound			West Bound		
	L	T	R	L	T	R	L	T	R	L	T	R
Min. Green:	7	10	10	7	10	10	7	10	10	7	10	10
Y+R:	4.0	4.0	4.0	4.0	4.0	4.0	4.0	4.0	4.0	4.0	4.0	4.0

Volume Module:												
Base Vol:	144	1206	31	18	547	425	388	204	146	4	45	83
Growth Adj:	1.00	1.00	1.00	1.00	1.00	1.00	1.00	1.00	1.00	1.00	1.00	1.00
Initial Bse:	144	1206	31	18	547	425	388	204	146	4	45	83
Added Vol:	11	22	0	0	5	0	0	0	2	0	0	0
PasserByVol:	9	56	2	0	175	0	0	0	51	2	0	0
Initial Fut:	164	1284	33	18	727	425	388	204	199	6	45	83
User Adj:	1.00	1.00	1.00	1.00	1.00	1.00	1.00	1.00	1.00	1.00	1.00	1.00
PHF Adj:	1.00	1.00	1.00	1.00	1.00	1.00	1.00	1.00	1.00	1.00	1.00	1.00
PHF Volume:	164	1284	33	18	727	425	388	204	199	6	45	83
Reduct Vol:	0	0	0	0	0	0	0	0	0	0	0	0
Reduced Vol:	164	1284	33	18	727	425	388	204	199	6	45	83
PCE Adj:	1.00	1.00	1.00	1.00	1.00	1.00	1.00	1.00	1.00	1.00	1.00	1.00
MLF Adj:	1.00	1.00	1.00	1.00	1.00	1.00	1.00	1.00	1.00	1.00	1.00	1.00
Final Volume:	164	1284	33	18	727	425	388	204	199	6	45	83

Saturation Flow Module:												
Sat/Lane:	1900	1900	1900	1900	1900	1900	1900	1900	1900	1900	1900	1900
Adjustment:	0.92	0.98	0.95	0.95	0.98	0.95	0.83	1.00	0.92	0.92	0.95	0.95
Lanes:	1.00	2.92	0.08	0.05	1.95	1.00	2.00	2.00	1.00	1.00	0.35	0.65
Final Sat.:	1750	5459	140	90	3615	1800	3150	3800	1750	1750	633	1167

Capacity Analysis Module:												
Vol/Sat:	0.09	0.24	0.24	0.00	0.20	0.24	0.12	0.05	0.11	0.00	0.07	0.07
Crit Moves:	****			****			****			****		
Green Time:	21.2	40.3	40.3	34.4	53.5	53.5	21.1	19.6	40.8	13.7	12.2	12.2
Volume/Cap:	0.53	0.70	0.70	0.70	0.45	0.53	0.70	0.33	0.33	0.03	0.70	0.70
Delay/Veh:	46.6	35.8	35.8	39.5	23.2	24.4	50.5	44.7	29.8	47.3	63.6	63.6
User DelAdj:	1.00	1.00	1.00	1.00	1.00	1.00	1.00	1.00	1.00	1.00	1.00	1.00
AdjDel/Veh:	46.6	35.8	35.8	39.5	23.2	24.4	50.5	44.7	29.8	47.3	63.6	63.6
LOS by Move:	D	D+	D+	D	C	C	D	D	C	D	E	E
HCM2kAvgQ:	6	14	14	13	9	12	9	3	6	0	6	6

Note: Queue reported is the number of cars per lane.

Hamptons Apartment Complex TIA
 SJ15-1612
 Background AM

Level Of Service Computation Report
 2000 HCM Operations (Future Volume Alternative)
 Background AM

Intersection #3: Wolfe Road / Marion Way

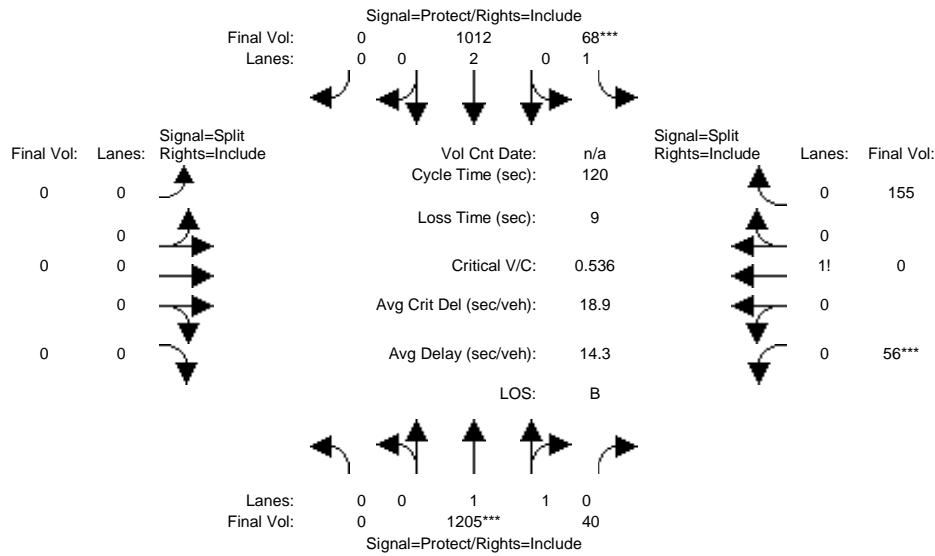

Street Name:	Wolfe Road						Marion Way					
	North Bound			South Bound			East Bound			West Bound		
Approach:	L	T	R	L	T	R	L	T	R	L	T	R
Min. Green:	7	10	10	7	10	10	0	0	0	7	10	10
Y+R:	4.0	4.0	4.0	4.0	4.0	4.0	4.0	4.0	4.0	4.0	4.0	4.0

Volume Module:												
Base Vol:	0	1142	40	68	791	0	0	0	0	56	0	155
Growth Adj:	1.00	1.00	1.00	1.00	1.00	1.00	1.00	1.00	1.00	1.00	1.00	1.00
Initial Bse:	0	1142	40	68	791	0	0	0	0	56	0	155
Added Vol:	0	0	0	0	0	0	0	0	0	0	0	0
PasserByVol:	0	63	0	0	221	0	0	0	0	0	0	0
Initial Fut:	0	1205	40	68	1012	0	0	0	0	56	0	155
User Adj:	1.00	1.00	1.00	1.00	1.00	1.00	1.00	1.00	1.00	1.00	1.00	1.00
PHF Adj:	1.00	1.00	1.00	1.00	1.00	1.00	1.00	1.00	1.00	1.00	1.00	1.00
PHF Volume:	0	1205	40	68	1012	0	0	0	0	56	0	155
Reduct Vol:	0	0	0	0	0	0	0	0	0	0	0	0
Reduced Vol:	0	1205	40	68	1012	0	0	0	0	56	0	155
PCE Adj:	1.00	1.00	1.00	1.00	1.00	1.00	1.00	1.00	1.00	1.00	1.00	1.00
MLF Adj:	1.00	1.00	1.00	1.00	1.00	1.00	1.00	1.00	1.00	1.00	1.00	1.00
Final Volume:	0	1205	40	68	1012	0	0	0	0	56	0	155

Saturation Flow Module:												
Sat/Lane:	1900	1900	1900	1900	1900	1900	1900	1900	1900	1900	1900	1900
Adjustment:	0.92	0.97	0.95	0.92	1.00	0.92	0.92	1.00	0.92	0.92	0.92	0.92
Lanes:	0.00	1.93	0.07	1.00	2.00	0.00	0.00	0.00	0.00	0.27	0.00	0.73
Final Sat.:	0	3581	119	1750	3800	0	0	0	0	464	0	1286

Capacity Analysis Module:												
Vol/Sat:	0.00	0.34	0.34	0.04	0.27	0.00	0.00	0.00	0.00	0.12	0.00	0.12
Crit Moves:	****			****						****		
Green Time:	0.0	75.3	75.3	8.7	84.0	0.0	0.0	0.0	0.0	27.0	0.0	27.0
Volume/Cap:	0.00	0.54	0.54	0.54	0.38	0.00	0.00	0.00	0.00	0.54	0.00	0.54
Delay/Veh:	0.0	12.8	12.8	58.2	7.4	0.0	0.0	0.0	0.0	42.4	0.0	42.4
User DelAdj:	1.00	1.00	1.00	1.00	1.00	1.00	1.00	1.00	1.00	1.00	1.00	1.00
AdjDel/Veh:	0.0	12.8	12.8	58.2	7.4	0.0	0.0	0.0	0.0	42.4	0.0	42.4
LOS by Move:	A	B	B	E+	A	A	A	A	A	D	A	D
HCM2kAvgQ:	0	13	13	3	7	0	0	0	0	8	0	8

Note: Queue reported is the number of cars per lane.

Hamptons Apartment Complex TIA
 SJ15-1612
 Background AM

Level Of Service Computation Report
 2000 HCM Operations (Future Volume Alternative)
 Background PP AM

Intersection #3: Wolfe Road / Marion Way

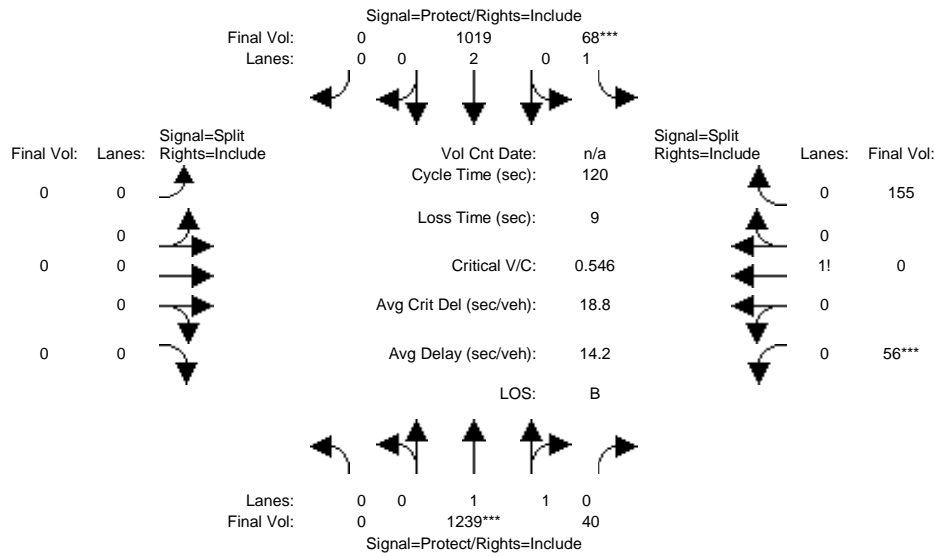

Street Name:	Wolfe Road						Marion Way					
	North Bound			South Bound			East Bound			West Bound		
Approach:	L	T	R	L	T	R	L	T	R	L	T	R
Min. Green:	7	10	10	7	10	10	0	0	0	7	10	10
Y+R:	4.0	4.0	4.0	4.0	4.0	4.0	4.0	4.0	4.0	4.0	4.0	4.0

Volume Module:												
Base Vol:	0	1142	40	68	791	0	0	0	0	56	0	155
Growth Adj:	1.00	1.00	1.00	1.00	1.00	1.00	1.00	1.00	1.00	1.00	1.00	1.00
Initial Bse:	0	1142	40	68	791	0	0	0	0	56	0	155
Added Vol:	0	34	0	0	7	0	0	0	0	0	0	0
PasserByVol:	0	63	0	0	221	0	0	0	0	0	0	0
Initial Fut:	0	1239	40	68	1019	0	0	0	0	56	0	155
User Adj:	1.00	1.00	1.00	1.00	1.00	1.00	1.00	1.00	1.00	1.00	1.00	1.00
PHF Adj:	1.00	1.00	1.00	1.00	1.00	1.00	1.00	1.00	1.00	1.00	1.00	1.00
PHF Volume:	0	1239	40	68	1019	0	0	0	0	56	0	155
Reduct Vol:	0	0	0	0	0	0	0	0	0	0	0	0
Reduced Vol:	0	1239	40	68	1019	0	0	0	0	56	0	155
PCE Adj:	1.00	1.00	1.00	1.00	1.00	1.00	1.00	1.00	1.00	1.00	1.00	1.00
MLF Adj:	1.00	1.00	1.00	1.00	1.00	1.00	1.00	1.00	1.00	1.00	1.00	1.00
Final Volume:	0	1239	40	68	1019	0	0	0	0	56	0	155

Saturation Flow Module:												
Sat/Lane:	1900	1900	1900	1900	1900	1900	1900	1900	1900	1900	1900	1900
Adjustment:	0.92	0.97	0.95	0.92	1.00	0.92	0.92	1.00	0.92	0.92	0.92	0.92
Lanes:	0.00	1.94	0.06	1.00	2.00	0.00	0.00	0.00	0.00	0.27	0.00	0.73
Final Sat.:	0	3584	116	1750	3800	0	0	0	0	464	0	1286

Capacity Analysis Module:												
Vol/Sat:	0.00	0.35	0.35	0.04	0.27	0.00	0.00	0.00	0.00	0.12	0.00	0.12
Crit Moves:	****			****						****		
Green Time:	0.0	76.0	76.0	8.5	84.5	0.0	0.0	0.0	0.0	26.5	0.0	26.5
Volume/Cap:	0.00	0.55	0.55	0.55	0.38	0.00	0.00	0.00	0.00	0.55	0.00	0.55
Delay/Veh:	0.0	12.6	12.6	58.8	7.3	0.0	0.0	0.0	0.0	43.1	0.0	43.1
User DelAdj:	1.00	1.00	1.00	1.00	1.00	1.00	1.00	1.00	1.00	1.00	1.00	1.00
AdjDel/Veh:	0.0	12.6	12.6	58.8	7.3	0.0	0.0	0.0	0.0	43.1	0.0	43.1
LOS by Move:	A	B	B	E+	A	A	A	A	A	D	A	D
HCM2kAvgQ:	0	13	13	3	7	0	0	0	0	8	0	8

Note: Queue reported is the number of cars per lane.

Hamptons Apartment Complex TIA
SJ15-1612
Background AM

Level Of Service Computation Report
2000 HCM Operations (Future Volume Alternative)
Background AM

Intersection #4: Wolfe Road / Inverness Avenue

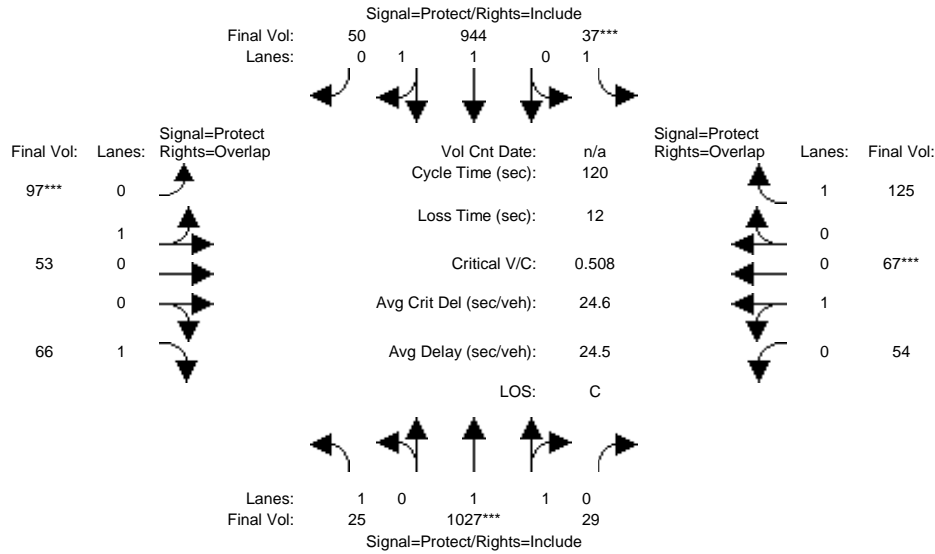

Street Name:	Wolfe Road						Inverness Avenue					
	North Bound			South Bound			East Bound			West Bound		
Approach:	North Bound			South Bound			East Bound			West Bound		
Movement:	L	T	R	L	T	R	L	T	R	L	T	R
Min. Green:	7	10	10	7	10	10	7	10	10	7	10	10
Y+R:	4.0	4.0	4.0	4.0	4.0	4.0	4.0	4.0	4.0	4.0	4.0	4.0

Volume Module:												
Base Vol:	22	964	29	37	723	50	97	53	41	50	67	125
Growth Adj:	1.00	1.00	1.00	1.00	1.00	1.00	1.00	1.00	1.00	1.00	1.00	1.00
Initial Bse:	22	964	29	37	723	50	97	53	41	50	67	125
Added Vol:	0	0	0	0	0	0	0	0	0	0	0	0
PasserByVol:	3	63	0	0	221	0	0	0	25	4	0	0
Initial Fut:	25	1027	29	37	944	50	97	53	66	54	67	125
User Adj:	1.00	1.00	1.00	1.00	1.00	1.00	1.00	1.00	1.00	1.00	1.00	1.00
PHF Adj:	1.00	1.00	1.00	1.00	1.00	1.00	1.00	1.00	1.00	1.00	1.00	1.00
PHF Volume:	25	1027	29	37	944	50	97	53	66	54	67	125
Reduct Vol:	0	0	0	0	0	0	0	0	0	0	0	0
Reduced Vol:	25	1027	29	37	944	50	97	53	66	54	67	125
PCE Adj:	1.00	1.00	1.00	1.00	1.00	1.00	1.00	1.00	1.00	1.00	1.00	1.00
MLF Adj:	1.00	1.00	1.00	1.00	1.00	1.00	1.00	1.00	1.00	1.00	1.00	1.00
Final Volume:	25	1027	29	37	944	50	97	53	66	54	67	125

Saturation Flow Module:												
Sat/Lane:	1900	1900	1900	1900	1900	1900	1900	1900	1900	1900	1900	1900
Adjustment:	0.92	0.97	0.95	0.92	0.98	0.95	0.95	0.95	0.92	0.95	0.95	0.92
Lanes:	1.00	1.94	0.06	1.00	1.90	0.10	0.65	0.35	1.00	0.45	0.55	1.00
Final Sat.:	1750	3598	102	1750	3514	186	1164	636	1750	803	997	1750

Capacity Analysis Module:												
Vol/Sat:	0.01	0.29	0.29	0.02	0.27	0.27	0.08	0.08	0.04	0.07	0.07	0.07
Crit Moves:	****			****			****			****		
Green Time:	13.0	66.1	66.1	7.0	60.1	60.1	19.3	19.3	32.4	15.6	15.6	22.6
Volume/Cap:	0.13	0.52	0.52	0.36	0.54	0.54	0.52	0.52	0.14	0.52	0.52	0.38
Delay/Veh:	48.7	17.2	17.2	56.5	20.8	20.8	47.7	47.7	33.4	50.8	50.8	43.3
User DelAdj:	1.00	1.00	1.00	1.00	1.00	1.00	1.00	1.00	1.00	1.00	1.00	1.00
AdjDel/Veh:	48.7	17.2	17.2	56.5	20.8	20.8	47.7	47.7	33.4	50.8	50.8	43.3
LOS by Move:	D	B	B	E+	C+	C+	D	D	C-	D	D	D
HCM2kAvgQ:	1	12	12	1	12	12	6	6	2	5	5	5

Note: Queue reported is the number of cars per lane.

Hamptons Apartment Complex TIA
SJ15-1612
Background AM

Level Of Service Computation Report
2000 HCM Operations (Future Volume Alternative)
Background PP AM

Intersection #4: Wolfe Road / Inverness Avenue

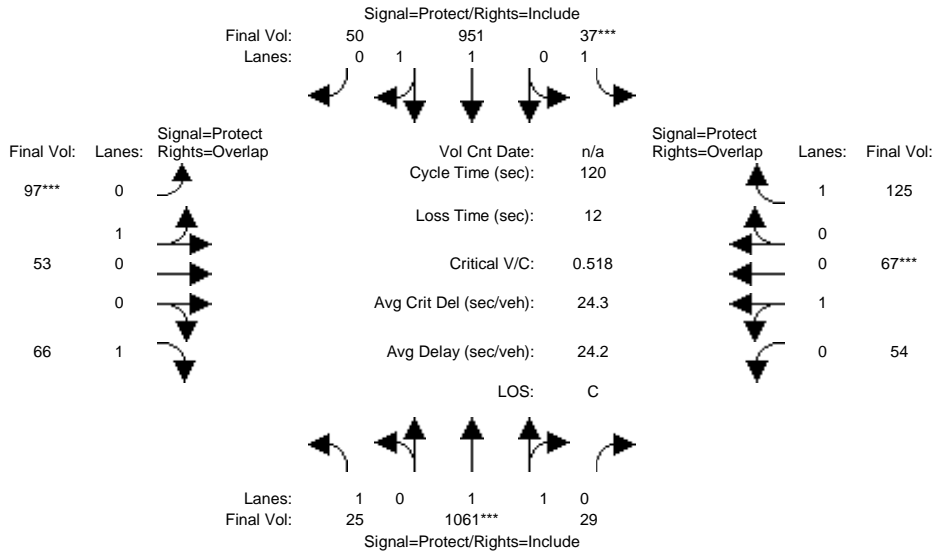

Street Name:	Wolfe Road						Inverness Avenue					
	North Bound			South Bound			East Bound			West Bound		
Approach:	North Bound			South Bound			East Bound			West Bound		
Movement:	L	T	R	L	T	R	L	T	R	L	T	R
Min. Green:	7	10	10	7	10	10	7	10	10	7	10	10
Y+R:	4.0	4.0	4.0	4.0	4.0	4.0	4.0	4.0	4.0	4.0	4.0	4.0

Volume Module:												
Base Vol:	22	964	29	37	723	50	97	53	41	50	67	125
Growth Adj:	1.00	1.00	1.00	1.00	1.00	1.00	1.00	1.00	1.00	1.00	1.00	1.00
Initial Bse:	22	964	29	37	723	50	97	53	41	50	67	125
Added Vol:	0	34	0	0	7	0	0	0	0	0	0	0
PasserByVol:	3	63	0	0	221	0	0	0	25	4	0	0
Initial Fut:	25	1061	29	37	951	50	97	53	66	54	67	125
User Adj:	1.00	1.00	1.00	1.00	1.00	1.00	1.00	1.00	1.00	1.00	1.00	1.00
PHF Adj:	1.00	1.00	1.00	1.00	1.00	1.00	1.00	1.00	1.00	1.00	1.00	1.00
PHF Volume:	25	1061	29	37	951	50	97	53	66	54	67	125
Reduct Vol:	0	0	0	0	0	0	0	0	0	0	0	0
Reduced Vol:	25	1061	29	37	951	50	97	53	66	54	67	125
PCE Adj:	1.00	1.00	1.00	1.00	1.00	1.00	1.00	1.00	1.00	1.00	1.00	1.00
MLF Adj:	1.00	1.00	1.00	1.00	1.00	1.00	1.00	1.00	1.00	1.00	1.00	1.00
Final Volume:	25	1061	29	37	951	50	97	53	66	54	67	125

Saturation Flow Module:												
Sat/Lane:	1900	1900	1900	1900	1900	1900	1900	1900	1900	1900	1900	1900
Adjustment:	0.92	0.97	0.95	0.92	0.98	0.95	0.95	0.95	0.92	0.95	0.95	0.92
Lanes:	1.00	1.95	0.05	1.00	1.90	0.10	0.65	0.35	1.00	0.45	0.55	1.00
Final Sat.:	1750	3601	98	1750	3515	185	1164	636	1750	803	997	1750

Capacity Analysis Module:												
Vol/Sat:	0.01	0.29	0.29	0.02	0.27	0.27	0.08	0.08	0.04	0.07	0.07	0.07
Crit Moves:	****			****			****			****		
Green Time:	13.1	66.8	66.8	7.0	60.7	60.7	18.9	18.9	32.0	15.3	15.3	22.3
Volume/Cap:	0.13	0.53	0.53	0.36	0.53	0.53	0.53	0.53	0.14	0.53	0.53	0.39
Delay/Veh:	48.6	17.0	17.0	56.5	20.4	20.4	48.3	48.3	33.7	51.3	51.3	43.6
User DelAdj:	1.00	1.00	1.00	1.00	1.00	1.00	1.00	1.00	1.00	1.00	1.00	1.00
AdjDel/Veh:	48.6	17.0	17.0	56.5	20.4	20.4	48.3	48.3	33.7	51.3	51.3	43.6
LOS by Move:	D	B	B	E+	C+	C+	D	D	C-	D-	D-	D
HCM2kAvgQ:	1	12	12	1	12	12	6	6	2	5	5	5

Note: Queue reported is the number of cars per lane.

Hamptons Apartment Complex TIA
 SJ15-1612
 Background AM

Level Of Service Computation Report
 2000 HCM Operations (Future Volume Alternative)
 Background AM

Intersection #5: Wolfe Road / Homestead Road

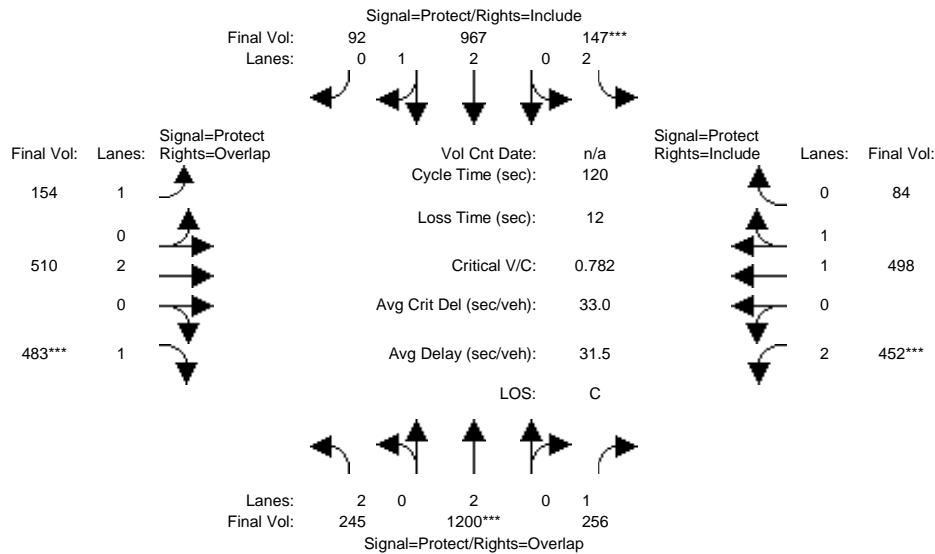

Street Name:	Wolfe Road						Homestead Road					
	North Bound			South Bound			East Bound			West Bound		
Approach:	L	T	R	L	T	R	L	T	R	L	T	R
Min. Green:	7	10	10	7	10	10	7	10	10	7	10	10
Y+R:	4.0	4.0	4.0	4.0	4.0	4.0	4.0	4.0	4.0	4.0	4.0	4.0

Volume Module:												
Base Vol:	211	1151	199	85	768	84	131	354	266	216	481	72
Growth Adj:	1.00	1.00	1.00	1.00	1.00	1.00	1.00	1.00	1.00	1.00	1.00	1.00
Initial Bse:	211	1151	199	85	768	84	131	354	266	216	481	72
Added Vol:	0	0	0	0	0	0	0	0	0	0	0	0
PasserByVol:	34	49	57	62	199	8	23	156	217	236	17	12
Initial Fut:	245	1200	256	147	967	92	154	510	483	452	498	84
User Adj:	1.00	1.00	1.00	1.00	1.00	1.00	1.00	1.00	1.00	1.00	1.00	1.00
PHF Adj:	1.00	1.00	1.00	1.00	1.00	1.00	1.00	1.00	1.00	1.00	1.00	1.00
PHF Volume:	245	1200	256	147	967	92	154	510	483	452	498	84
Reduct Vol:	0	0	0	0	0	0	0	0	0	0	0	0
Reduced Vol:	245	1200	256	147	967	92	154	510	483	452	498	84
PCE Adj:	1.00	1.00	1.00	1.00	1.00	1.00	1.00	1.00	1.00	1.00	1.00	1.00
MLF Adj:	1.00	1.00	1.00	1.00	1.00	1.00	1.00	1.00	1.00	1.00	1.00	1.00
Final Volume:	245	1200	256	147	967	92	154	510	483	452	498	84

Saturation Flow Module:												
Sat/Lane:	1900	1900	1900	1900	1900	1900	1900	1900	1900	1900	1900	1900
Adjustment:	0.83	1.00	0.92	0.83	0.99	0.95	0.92	1.00	0.92	0.83	0.98	0.95
Lanes:	2.00	2.00	1.00	2.00	2.73	0.27	1.00	2.00	1.00	2.00	1.70	0.30
Final Sat.:	3150	3800	1750	3150	5113	486	1750	3800	1750	3150	3166	534

Capacity Analysis Module:												
Vol/Sat:	0.08	0.32	0.15	0.05	0.19	0.19	0.09	0.13	0.28	0.14	0.16	0.16
Crit Moves:	****			****			****			****		
Green Time:	16.2	48.4	70.4	7.2	39.4	39.4	18.8	30.4	46.6	22.0	33.6	33.6
Volume/Cap:	0.58	0.78	0.25	0.78	0.58	0.58	0.56	0.53	0.71	0.78	0.56	0.56
Delay/Veh:	45.6	19.8	0.8	72.2	23.0	23.0	49.4	39.2	34.5	53.6	37.6	37.6
User DelAdj:	1.00	1.00	1.00	1.00	1.00	1.00	1.00	1.00	1.00	1.00	1.00	1.00
AdjDel/Veh:	45.6	19.8	0.8	72.2	23.0	23.0	49.4	39.2	34.5	53.6	37.6	37.6
LOS by Move:	D	B-	A	E	C+	C+	D	D	C-	D-	D+	D+
HCM2kAvgQ:	5	16	1	3	9	9	6	8	16	9	8	8

Note: Queue reported is the number of cars per lane.

Hamptons Apartment Complex TIA
 SJ15-1612
 Background AM

Level Of Service Computation Report
 2000 HCM Operations (Future Volume Alternative)
 Background PP AM

Intersection #5: Wolfe Road / Homestead Road

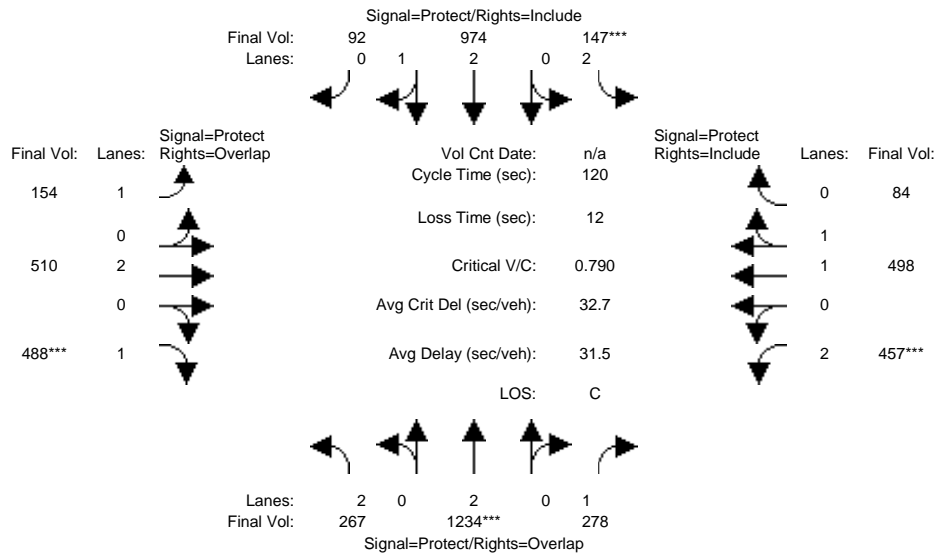

Street Name:	Wolfe Road						Homestead Road					
	North Bound			South Bound			East Bound			West Bound		
Approach:	North Bound			South Bound			East Bound			West Bound		
Movement:	L	T	R	L	T	R	L	T	R	L	T	R
Min. Green:	7	10	10	7	10	10	7	10	10	7	10	10
Y+R:	4.0	4.0	4.0	4.0	4.0	4.0	4.0	4.0	4.0	4.0	4.0	4.0

Volume Module:												
Base Vol:	211	1151	199	85	768	84	131	354	266	216	481	72
Growth Adj:	1.00	1.00	1.00	1.00	1.00	1.00	1.00	1.00	1.00	1.00	1.00	1.00
Initial Bse:	211	1151	199	85	768	84	131	354	266	216	481	72
Added Vol:	22	34	22	0	7	0	0	0	5	5	0	0
PasserByVol:	34	49	57	62	199	8	23	156	217	236	17	12
Initial Fut:	267	1234	278	147	974	92	154	510	488	457	498	84
User Adj:	1.00	1.00	1.00	1.00	1.00	1.00	1.00	1.00	1.00	1.00	1.00	1.00
PHF Adj:	1.00	1.00	1.00	1.00	1.00	1.00	1.00	1.00	1.00	1.00	1.00	1.00
PHF Volume:	267	1234	278	147	974	92	154	510	488	457	498	84
Reduct Vol:	0	0	0	0	0	0	0	0	0	0	0	0
Reduced Vol:	267	1234	278	147	974	92	154	510	488	457	498	84
PCE Adj:	1.00	1.00	1.00	1.00	1.00	1.00	1.00	1.00	1.00	1.00	1.00	1.00
MLF Adj:	1.00	1.00	1.00	1.00	1.00	1.00	1.00	1.00	1.00	1.00	1.00	1.00
Final Volume:	267	1234	278	147	974	92	154	510	488	457	498	84

Saturation Flow Module:												
Sat/Lane:	1900	1900	1900	1900	1900	1900	1900	1900	1900	1900	1900	1900
Adjustment:	0.83	1.00	0.92	0.83	0.99	0.95	0.92	1.00	0.92	0.83	0.98	0.95
Lanes:	2.00	2.00	1.00	2.00	2.73	0.27	1.00	2.00	1.00	2.00	1.70	0.30
Final Sat.:	3150	3800	1750	3150	5116	483	1750	3800	1750	3150	3166	534

Capacity Analysis Module:												
Vol/Sat:	0.08	0.32	0.16	0.05	0.19	0.19	0.09	0.13	0.28	0.15	0.16	0.16
Crit Moves:	****			****			****			****		
Green Time:	17.4	49.4	71.4	7.1	39.1	39.1	18.5	29.5	46.9	22.1	33.1	33.1
Volume/Cap:	0.58	0.79	0.27	0.79	0.58	0.58	0.57	0.55	0.71	0.79	0.57	0.57
Delay/Veh:	44.5	19.2	0.4	73.3	23.4	23.4	50.0	40.1	34.5	54.0	38.2	38.2
User DelAdj:	1.00	1.00	1.00	1.00	1.00	1.00	1.00	1.00	1.00	1.00	1.00	1.00
AdjDel/Veh:	44.5	19.2	0.4	73.3	23.4	23.4	50.0	40.1	34.5	54.0	38.2	38.2
LOS by Move:	D	B-	A	E	C	C	D	D	C-	D-	D+	D+
HCM2kAvgQ:	5	16	0	3	9	9	6	8	16	10	8	8

Note: Queue reported is the number of cars per lane.

Hamptons Apartment Complex TIA
SJ15-1612
Background AM

Level Of Service Computation Report
2000 HCM Operations (Future Volume Alternative)
Background AM

Intersection #6: Wolfe Road / Apple Campus 2

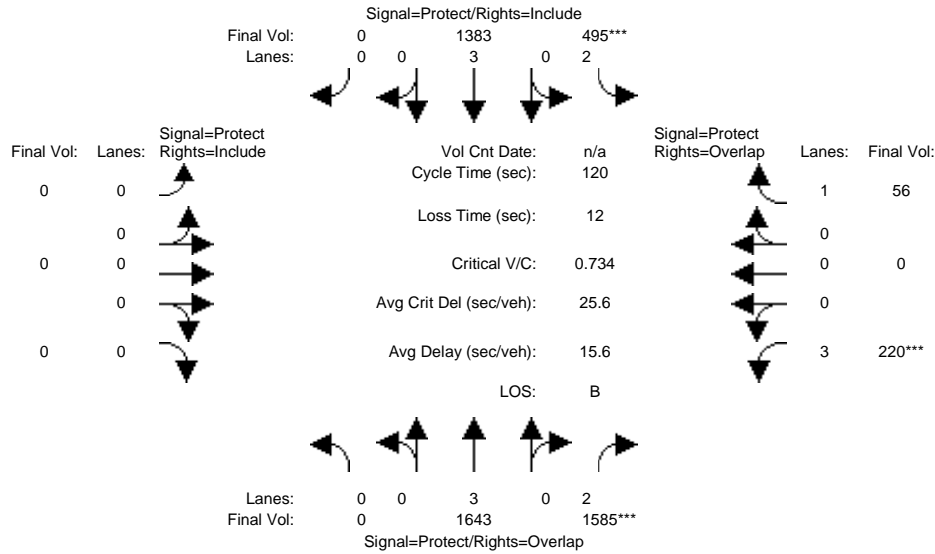

Street Name:	Wolfe Road						Apple Campus 2					
	North Bound			South Bound			East Bound			West Bound		
Approach:	L	T	R	L	T	R	L	T	R	L	T	R
Min. Green:	7	10	10	7	10	10	7	10	10	7	10	10
Y+R:	4.0	4.0	4.0	4.0	4.0	4.0	4.0	4.0	4.0	4.0	4.0	4.0

Volume Module:												
Base Vol:	0	1561	0	0	1250	0	0	0	0	0	0	0
Growth Adj:	1.00	1.00	1.00	1.00	1.00	1.00	1.00	1.00	1.00	1.00	1.00	1.00
Initial Bse:	0	1561	0	0	1250	0	0	0	0	0	0	0
Added Vol:	0	0	0	0	0	0	0	0	0	0	0	0
PasserByVol:	0	82	1585	495	133	0	0	0	0	220	0	56
Initial Fut:	0	1643	1585	495	1383	0	0	0	0	220	0	56
User Adj:	1.00	1.00	1.00	1.00	1.00	1.00	1.00	1.00	1.00	1.00	1.00	1.00
PHF Adj:	1.00	1.00	1.00	1.00	1.00	1.00	1.00	1.00	1.00	1.00	1.00	1.00
PHF Volume:	0	1643	1585	495	1383	0	0	0	0	220	0	56
Reduct Vol:	0	0	0	0	0	0	0	0	0	0	0	0
Reduced Vol:	0	1643	1585	495	1383	0	0	0	0	220	0	56
PCE Adj:	1.00	1.00	1.00	1.00	1.00	1.00	1.00	1.00	1.00	1.00	1.00	1.00
MLF Adj:	1.00	1.00	1.00	1.00	1.00	1.00	1.00	1.00	1.00	1.00	1.00	1.00
FinalVolume:	0	1643	1585	495	1383	0	0	0	0	220	0	56

Saturation Flow Module:												
Sat/Lane:	1900	1900	1900	1900	1900	1900	1900	1900	1900	1900	1900	1900
Adjustment:	0.92	1.00	0.83	0.83	1.00	0.92	0.92	1.00	0.92	0.80	1.00	0.92
Lanes:	0.00	3.00	2.00	2.00	3.00	0.00	0.00	0.00	0.00	3.00	0.00	1.00
Final Sat.:	0	5700	3150	3150	5700	0	0	0	0	4551	0	1750

Capacity Analysis Module:												
Vol/Sat:	0.00	0.29	0.50	0.16	0.24	0.00	0.00	0.00	0.00	0.05	0.00	0.03
Crit Moves:			****	****						****		
Green Time:	0.0	74.4	82.3	25.7	100	0.0	0.0	0.0	0.0	7.9	0.0	33.6
Volume/Cap:	0.00	0.46	0.73	0.73	0.29	0.00	0.00	0.00	0.00	0.73	0.00	0.11
Delay/Veh:	0.0	12.3	13.3	48.1	2.2	0.0	0.0	0.0	0.0	64.0	0.0	32.2
User DelAdj:	1.00	1.00	1.00	1.00	1.00	1.00	1.00	1.00	1.00	1.00	1.00	1.00
AdjDel/Veh:	0.0	12.3	13.3	48.1	2.2	0.0	0.0	0.0	0.0	64.0	0.0	32.2
LOS by Move:	A	B	B	D	A	A	A	A	A	E	A	C-
HCM2kAvgQ:	0	10	22	10	4	0	0	0	0	5	0	2

Note: Queue reported is the number of cars per lane.

Hamptons Apartment Complex TIA
SJ15-1612
Background AM

Level Of Service Computation Report
2000 HCM Operations (Future Volume Alternative)
Background PP AM

Intersection #6: Wolfe Road / Apple Campus 2

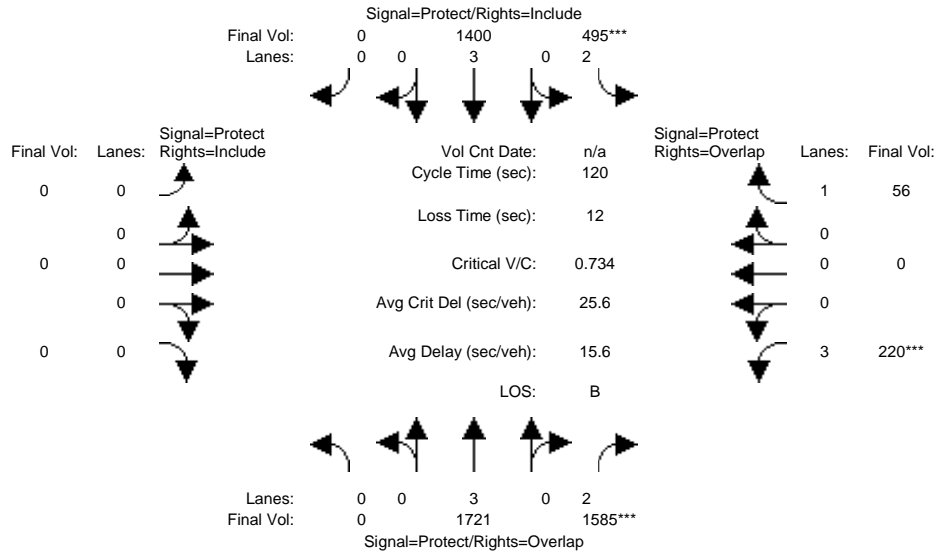

Street Name:	Wolfe Road						Apple Campus 2					
	North Bound			South Bound			East Bound			West Bound		
Approach:	L	T	R	L	T	R	L	T	R	L	T	R
Min. Green:	7	10	10	7	10	10	7	10	10	7	10	10
Y+R:	4.0	4.0	4.0	4.0	4.0	4.0	4.0	4.0	4.0	4.0	4.0	4.0

Volume Module:												
Base Vol:	0	1561	0	0	1250	0	0	0	0	0	0	0
Growth Adj:	1.00	1.00	1.00	1.00	1.00	1.00	1.00	1.00	1.00	1.00	1.00	1.00
Initial Bse:	0	1561	0	0	1250	0	0	0	0	0	0	0
Added Vol:	0	78	0	0	17	0	0	0	0	0	0	0
PasserByVol:	0	82	1585	495	133	0	0	0	0	220	0	56
Initial Fut:	0	1721	1585	495	1400	0	0	0	0	220	0	56
User Adj:	1.00	1.00	1.00	1.00	1.00	1.00	1.00	1.00	1.00	1.00	1.00	1.00
PHF Adj:	1.00	1.00	1.00	1.00	1.00	1.00	1.00	1.00	1.00	1.00	1.00	1.00
PHF Volume:	0	1721	1585	495	1400	0	0	0	0	220	0	56
Reduct Vol:	0	0	0	0	0	0	0	0	0	0	0	0
Reduced Vol:	0	1721	1585	495	1400	0	0	0	0	220	0	56
PCE Adj:	1.00	1.00	1.00	1.00	1.00	1.00	1.00	1.00	1.00	1.00	1.00	1.00
MLF Adj:	1.00	1.00	1.00	1.00	1.00	1.00	1.00	1.00	1.00	1.00	1.00	1.00
Final Volume:	0	1721	1585	495	1400	0	0	0	0	220	0	56

Saturation Flow Module:												
Sat/Lane:	1900	1900	1900	1900	1900	1900	1900	1900	1900	1900	1900	1900
Adjustment:	0.92	1.00	0.83	0.83	1.00	0.92	0.92	1.00	0.92	0.80	1.00	0.92
Lanes:	0.00	3.00	2.00	2.00	3.00	0.00	0.00	0.00	0.00	3.00	0.00	1.00
Final Sat.:	0	5700	3150	3150	5700	0	0	0	0	4551	0	1750

Capacity Analysis Module:												
Vol/Sat:	0.00	0.30	0.50	0.16	0.25	0.00	0.00	0.00	0.00	0.05	0.00	0.03
Crit Moves:			****	****						****		
Green Time:	0.0	74.4	82.3	25.7	100	0.0	0.0	0.0	0.0	7.9	0.0	33.6
Volume/Cap:	0.00	0.49	0.73	0.73	0.29	0.00	0.00	0.00	0.00	0.73	0.00	0.11
Delay/Veh:	0.0	12.5	13.3	48.1	2.2	0.0	0.0	0.0	0.0	64.0	0.0	32.2
User DelAdj:	1.00	1.00	1.00	1.00	1.00	1.00	1.00	1.00	1.00	1.00	1.00	1.00
AdjDel/Veh:	0.0	12.5	13.3	48.1	2.2	0.0	0.0	0.0	0.0	64.0	0.0	32.2
LOS by Move:	A	B	B	D	A	A	A	A	A	E	A	C-
HCM2kAvgQ:	0	11	22	10	4	0	0	0	0	5	0	2

Note: Queue reported is the number of cars per lane.

Hamptons Apartment Complex TIA
SJ15-1612
Background AM

Level Of Service Computation Report
2000 HCM Operations (Future Volume Alternative)
Background AM

Intersection #7: Wolfe Road / Pruneridge Avenue

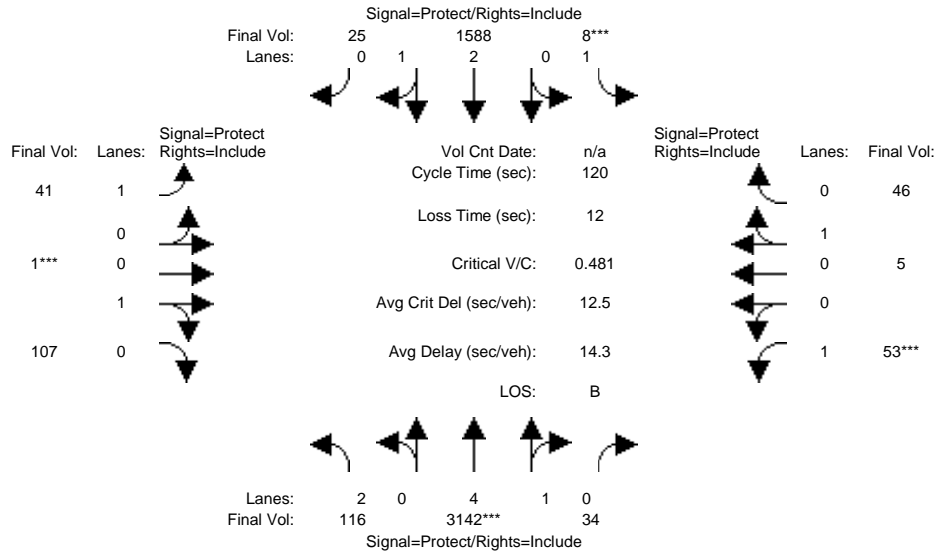

Street Name:	Wolfe Road						Pruneridge Avenue					
	North Bound			South Bound			East Bound			West Bound		
Approach:												
Movement:	L	T	R	L	T	R	L	T	R	L	T	R
Min. Green:	7	10	10	7	10	10	7	10	10	7	10	10
Y+R:	4.0	4.0	4.0	4.0	4.0	4.0	4.0	4.0	4.0	4.0	4.0	4.0

Volume Module:												
Base Vol:	102	1474	34	7	1219	24	41	1	105	53	5	46
Growth Adj:	1.00	1.00	1.00	1.00	1.00	1.00	1.00	1.00	1.00	1.00	1.00	1.00
Initial Bse:	102	1474	34	7	1219	24	41	1	105	53	5	46
Added Vol:	0	0	0	0	0	0	0	0	0	0	0	0
PasserByVol:	14	1668	0	1	369	1	0	0	2	0	0	0
Initial Fut:	116	3142	34	8	1588	25	41	1	107	53	5	46
User Adj:	1.00	1.00	1.00	1.00	1.00	1.00	1.00	1.00	1.00	1.00	1.00	1.00
PHF Adj:	1.00	1.00	1.00	1.00	1.00	1.00	1.00	1.00	1.00	1.00	1.00	1.00
PHF Volume:	116	3142	34	8	1588	25	41	1	107	53	5	46
Reduct Vol:	0	0	0	0	0	0	0	0	0	0	0	0
Reduced Vol:	116	3142	34	8	1588	25	41	1	107	53	5	46
PCE Adj:	1.00	1.00	1.00	1.00	1.00	1.00	1.00	1.00	1.00	1.00	1.00	1.00
MLF Adj:	1.00	1.00	1.00	1.00	1.00	1.00	1.00	1.00	1.00	1.00	1.00	1.00
Final Volume:	116	3142	34	8	1588	25	41	1	107	53	5	46

Saturation Flow Module:												
Sat/Lane:	1900	1900	1900	1900	1900	1900	1900	1900	1900	1900	1900	1900
Adjustment:	0.83	0.99	0.95	0.92	0.98	0.95	0.92	0.95	0.95	0.92	0.95	0.95
Lanes:	2.00	4.94	0.06	1.00	2.95	0.05	1.00	0.01	0.99	1.00	0.10	0.90
Final Sat.:	3150	9299	101	1750	5513	87	1750	17	1783	1750	176	1624

Capacity Analysis Module:												
Vol/Sat:	0.04	0.34	0.34	0.00	0.29	0.29	0.02	0.06	0.06	0.03	0.03	0.03
Crit Moves:	****			****			****			****		
Green Time:	14.6	79.7	79.7	7.0	72.1	72.1	8.8	14.2	14.2	7.1	12.5	12.5
Volume/Cap:	0.30	0.51	0.51	0.08	0.48	0.48	0.32	0.51	0.51	0.51	0.27	0.27
Delay/Veh:	48.5	10.3	10.3	53.8	13.5	13.5	54.2	51.7	51.7	58.8	50.3	50.3
User DelAdj:	1.00	1.00	1.00	1.00	1.00	1.00	1.00	1.00	1.00	1.00	1.00	1.00
AdjDel/Veh:	48.5	10.3	10.3	53.8	13.5	13.5	54.2	51.7	51.7	58.8	50.3	50.3
LOS by Move:	D	B+	B+	D-	B	B	D-	D-	D-	E+	D	D
HCM2kAvgQ:	2	11	11	0	11	11	2	5	5	3	2	2

Note: Queue reported is the number of cars per lane.

Hamptons Apartment Complex TIA
SJ15-1612
Background AM

Level Of Service Computation Report
2000 HCM Operations (Future Volume Alternative)
Background PP AM

Intersection #7: Wolfe Road / Pruneridge Avenue

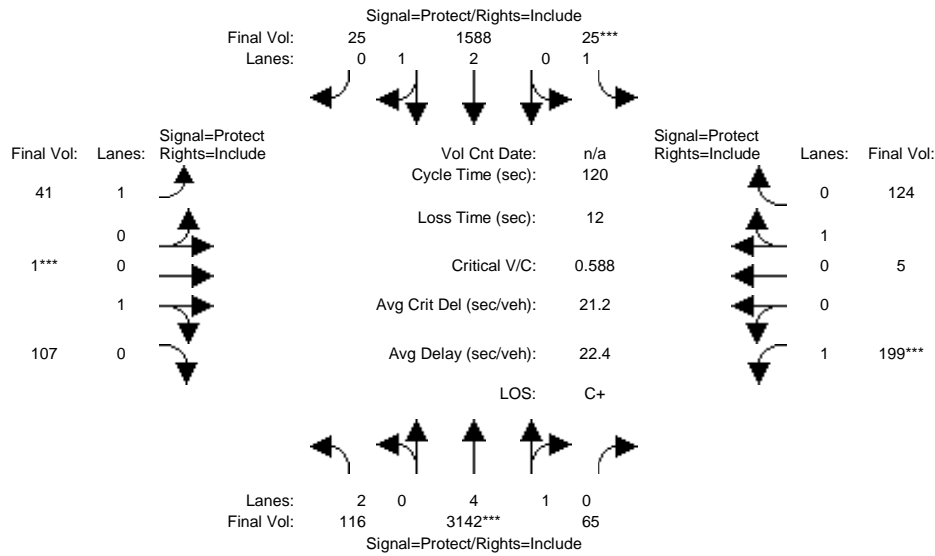

Street Name:	Wolfe Road						Pruneridge Avenue					
	North Bound			South Bound			East Bound			West Bound		
Approach:	L	T	R	L	T	R	L	T	R	L	T	R
Movement:												
Min. Green:	7	10	10	7	10	10	7	10	10	7	10	10
Y+R:	4.0	4.0	4.0	4.0	4.0	4.0	4.0	4.0	4.0	4.0	4.0	4.0

Volume Module:												
Base Vol:	102	1474	34	7	1219	24	41	1	105	53	5	46
Growth Adj:	1.00	1.00	1.00	1.00	1.00	1.00	1.00	1.00	1.00	1.00	1.00	1.00
Initial Bse:	102	1474	34	7	1219	24	41	1	105	53	5	46
Added Vol:	0	0	31	17	0	0	0	0	0	146	0	78
PasserByVol:	14	1668	0	1	369	1	0	0	2	0	0	0
Initial Fut:	116	3142	65	25	1588	25	41	1	107	199	5	124
User Adj:	1.00	1.00	1.00	1.00	1.00	1.00	1.00	1.00	1.00	1.00	1.00	1.00
PHF Adj:	1.00	1.00	1.00	1.00	1.00	1.00	1.00	1.00	1.00	1.00	1.00	1.00
PHF Volume:	116	3142	65	25	1588	25	41	1	107	199	5	124
Reduct Vol:	0	0	0	0	0	0	0	0	0	0	0	0
Reduced Vol:	116	3142	65	25	1588	25	41	1	107	199	5	124
PCE Adj:	1.00	1.00	1.00	1.00	1.00	1.00	1.00	1.00	1.00	1.00	1.00	1.00
MLF Adj:	1.00	1.00	1.00	1.00	1.00	1.00	1.00	1.00	1.00	1.00	1.00	1.00
Final Volume:	116	3142	65	25	1588	25	41	1	107	199	5	124

Saturation Flow Module:												
Sat/Lane:	1900	1900	1900	1900	1900	1900	1900	1900	1900	1900	1900	1900
Adjustment:	0.83	0.99	0.95	0.92	0.98	0.95	0.92	0.95	0.95	0.92	0.95	0.95
Lanes:	2.00	4.89	0.11	1.00	2.95	0.05	1.00	0.01	0.99	1.00	0.04	0.96
Final Sat.:	3150	9209	191	1750	5513	87	1750	17	1783	1750	70	1730

Capacity Analysis Module:												
Vol/Sat:	0.04	0.34	0.34	0.01	0.29	0.29	0.02	0.06	0.06	0.11	0.07	0.07
Crit Moves:	****			****			****			****		
Green Time:	12.4	66.9	66.9	7.0	61.5	61.5	14.0	11.8	11.8	22.3	20.0	20.0
Volume/Cap:	0.35	0.61	0.61	0.24	0.56	0.56	0.20	0.61	0.61	0.61	0.43	0.43
Delay/Veh:	50.7	18.0	18.0	55.2	20.3	20.3	48.4	58.1	58.1	48.3	45.8	45.8
User DelAdj:	1.00	1.00	1.00	1.00	1.00	1.00	1.00	1.00	1.00	1.00	1.00	1.00
AdjDel/Veh:	50.7	18.0	18.0	55.2	20.3	20.3	48.4	58.1	58.1	48.3	45.8	45.8
LOS by Move:	D	B-	B-	E+	C+	C+	D	E+	E+	D	D	D
HCM2kAvgQ:	2	15	15	1	13	13	2	5	5	8	5	5

Note: Queue reported is the number of cars per lane.

Hamptons Apartment Complex TIA
SJ15-1612
Background AM

Level Of Service Computation Report
2000 HCM Operations (Future Volume Alternative)
Background AM

Intersection #8: Wolfe Road / I-280 NB Ramps

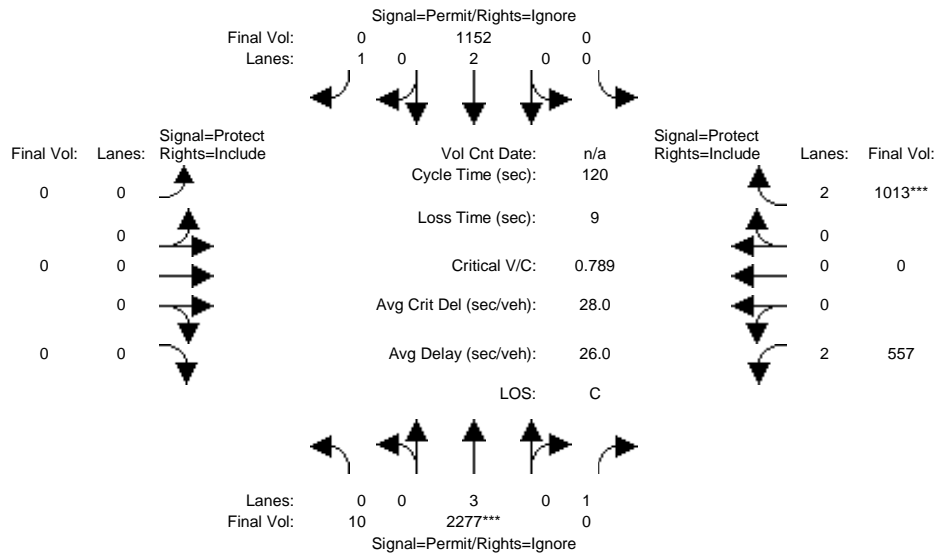

Street Name:	Wolfe Road						I-280 NB Ramps					
Approach:	North Bound			South Bound			East Bound			West Bound		
Movement:	L	T	R	L	T	R	L	T	R	L	T	R
Min. Green:	7	10	10	7	10	10	0	0	0	10	10	10
Y+R:	5.0	5.0	5.0	5.0	5.0	5.0	5.0	5.0	5.0	5.0	5.0	5.0
Volume Module:												
Base Vol:	0	1120	410	0	918	459	0	0	0	515	0	490
Growth Adj:	1.00	1.00	1.00	1.00	1.00	1.00	1.00	1.00	1.00	1.00	1.00	1.00
Initial Bse:	0	1120	410	0	918	459	0	0	0	515	0	490
Added Vol:	0	0	0	0	0	0	0	0	0	0	0	0
PasserByVol:	10	1157	104	0	234	137	0	0	0	42	0	523
Initial Fut:	10	2277	514	0	1152	596	0	0	0	557	0	1013
User Adj:	1.00	1.00	0.00	1.00	1.00	0.00	1.00	1.00	1.00	1.00	1.00	1.00
PHF Adj:	1.00	1.00	0.00	1.00	1.00	0.00	1.00	1.00	1.00	1.00	1.00	1.00
PHF Volume:	10	2277	0	0	1152	0	0	0	0	557	0	1013
Reduct Vol:	0	0	0	0	0	0	0	0	0	0	0	0
Reduced Vol:	10	2277	0	0	1152	0	0	0	0	557	0	1013
PCE Adj:	1.00	1.00	0.00	1.00	1.00	0.00	1.00	1.00	1.00	1.00	1.00	1.00
MLF Adj:	1.00	1.00	0.00	1.00	1.00	0.00	1.00	1.00	1.00	1.00	1.00	1.00
Final Volume:	10	2277	0	0	1152	0	0	0	0	557	0	1013
Saturation Flow Module:												
Sat/Lane:	1900	1900	1900	1900	1900	1900	1900	1900	1900	1900	1900	1900
Adjustment:	0.95	0.98	0.92	0.92	1.00	0.92	0.92	1.00	0.92	0.83	1.00	0.83
Lanes:	0.01	2.99	1.00	0.00	2.00	1.00	0.00	0.00	0.00	2.00	0.00	2.00
Final Sat.:	24	5575	1750	0	3800	1750	0	0	0	3150	0	3150
Capacity Analysis Module:												
Vol/Sat:	0.41	0.41	0.00	0.00	0.30	0.00	0.00	0.00	0.00	0.18	0.00	0.32
Crit Moves:	****											
Green Time:	62.1	62.1	0.0	0.0	62.1	0.0	0.0	0.0	0.0	48.9	0.0	48.9
Volume/Cap:	0.79	0.79	0.00	0.00	0.59	0.00	0.00	0.00	0.00	0.43	0.00	0.79
Delay/Veh:	25.1	25.1	0.0	0.0	20.5	0.0	0.0	0.0	0.0	25.8	0.0	34.4
User DelAdj:	1.00	1.00	1.00	1.00	1.00	1.00	1.00	1.00	1.00	1.00	1.00	1.00
AdjDel/Veh:	25.1	25.1	0.0	0.0	20.5	0.0	0.0	0.0	0.0	25.8	0.0	34.4
LOS by Move:	C	C	A	A	C+	A	A	A	A	C	A	C-
HCM2kAvgQ:	12	12	0	0	6	0	0	0	0	9	0	21

Note: Queue reported is the number of cars per lane.

Hamptons Apartment Complex TIA
 SJ15-1612
 Background AM

Level Of Service Computation Report
 2000 HCM Operations (Future Volume Alternative)
 Background PP AM

Intersection #8: Wolfe Road / I-280 NB Ramps

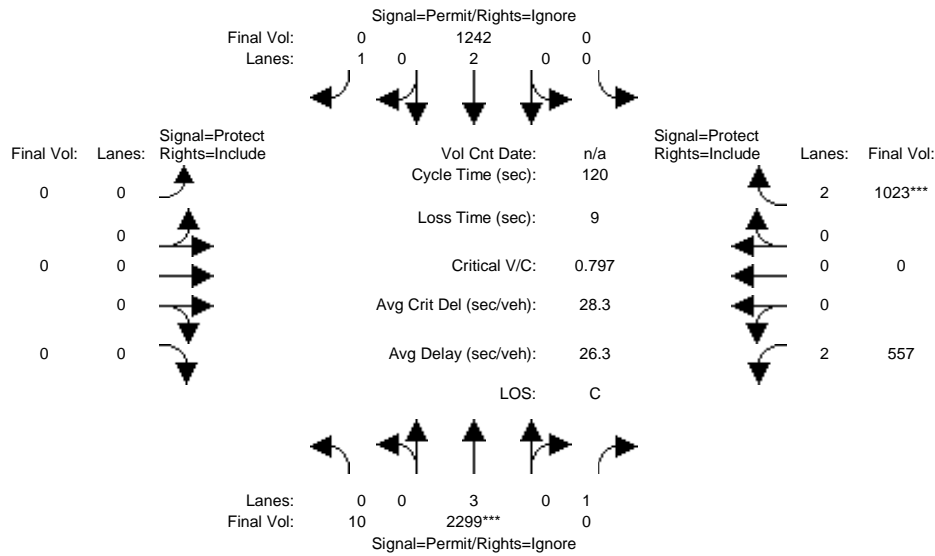

Street Name:	Wolfe Road						I-280 NB Ramps					
Approach:	North Bound			South Bound			East Bound			West Bound		
Movement:	L	T	R	L	T	R	L	T	R	L	T	R
Min. Green:	7	10	10	7	10	10	0	0	0	10	10	10
Y+R:	5.0	5.0	5.0	5.0	5.0	5.0	5.0	5.0	5.0	5.0	5.0	5.0
Volume Module:												
Base Vol:	0	1120	410	0	918	459	0	0	0	515	0	490
Growth Adj:	1.00	1.00	1.00	1.00	1.00	1.00	1.00	1.00	1.00	1.00	1.00	1.00
Initial Bse:	0	1120	410	0	918	459	0	0	0	515	0	490
Added Vol:	0	22	0	0	90	56	0	0	0	0	0	10
PasserByVol:	10	1157	104	0	234	137	0	0	0	42	0	523
Initial Fut:	10	2299	514	0	1242	652	0	0	0	557	0	1023
User Adj:	1.00	1.00	0.00	1.00	1.00	0.00	1.00	1.00	1.00	1.00	1.00	1.00
PHF Adj:	1.00	1.00	0.00	1.00	1.00	0.00	1.00	1.00	1.00	1.00	1.00	1.00
PHF Volume:	10	2299	0	0	1242	0	0	0	0	557	0	1023
Reduct Vol:	0	0	0	0	0	0	0	0	0	0	0	0
Reduced Vol:	10	2299	0	0	1242	0	0	0	0	557	0	1023
PCE Adj:	1.00	1.00	0.00	1.00	1.00	0.00	1.00	1.00	1.00	1.00	1.00	1.00
MLF Adj:	1.00	1.00	0.00	1.00	1.00	0.00	1.00	1.00	1.00	1.00	1.00	1.00
Final Volume:	10	2299	0	0	1242	0	0	0	0	557	0	1023
Saturation Flow Module:												
Sat/Lane:	1900	1900	1900	1900	1900	1900	1900	1900	1900	1900	1900	1900
Adjustment:	0.95	0.98	0.92	0.92	1.00	0.92	0.92	1.00	0.92	0.83	1.00	0.83
Lanes:	0.01	2.99	1.00	0.00	2.00	1.00	0.00	0.00	0.00	2.00	0.00	2.00
Final Sat.:	24	5576	1750	0	3800	1750	0	0	0	3150	0	3150
Capacity Analysis Module:												
Vol/Sat:	0.41	0.41	0.00	0.00	0.33	0.00	0.00	0.00	0.00	0.18	0.00	0.32
Crit Moves:	****											
Green Time:	62.1	62.1	0.0	0.0	62.1	0.0	0.0	0.0	0.0	48.9	0.0	48.9
Volume/Cap:	0.80	0.80	0.00	0.00	0.63	0.00	0.00	0.00	0.00	0.43	0.00	0.80
Delay/Veh:	25.4	25.4	0.0	0.0	21.4	0.0	0.0	0.0	0.0	25.8	0.0	34.8
User DelAdj:	1.00	1.00	1.00	1.00	1.00	1.00	1.00	1.00	1.00	1.00	1.00	1.00
AdjDel/Veh:	25.4	25.4	0.0	0.0	21.4	0.0	0.0	0.0	0.0	25.8	0.0	34.8
LOS by Move:	C	C	A	A	C+	A	A	A	A	C	A	C-
HCM2kAvgQ:	13	13	0	0	7	0	0	0	0	9	0	21

Note: Queue reported is the number of cars per lane.

Hamptons Apartment Complex TIA
SJ15-1612
Background AM

Level Of Service Computation Report
2000 HCM Operations (Future Volume Alternative)
Background AM

Intersection #9: Wolfe Road / I-280 SB Ramps

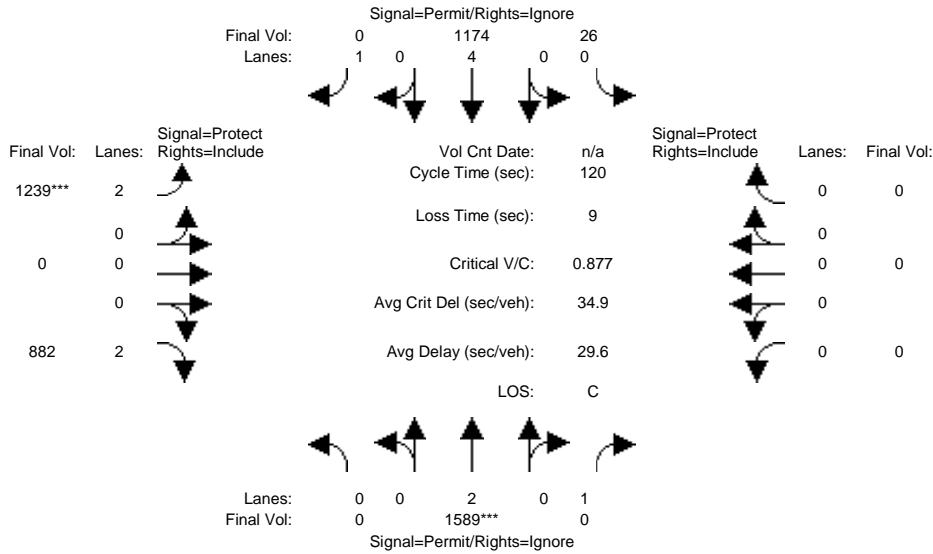

Street Name:	Wolfe Road						I-280 SB Ramps					
Approach:	North Bound			South Bound			East Bound			West Bound		
Movement:	L	T	R	L	T	R	L	T	R	L	T	R
Min. Green:	7	10	10	7	10	10	10	10	10	0	0	0
Y+R:	5.0	5.0	5.0	5.0	5.0	5.0	5.0	5.0	5.0	5.0	5.0	5.0
Volume Module:												
Base Vol:	0	1093	365	0	1015	418	437	0	440	0	0	0
Growth Adj:	1.00	1.00	1.00	1.00	1.00	1.00	1.00	1.00	1.00	1.00	1.00	1.00
Initial Bse:	0	1093	365	0	1015	418	437	0	440	0	0	0
Added Vol:	0	0	0	0	0	0	0	0	0	0	0	0
PasserByVol:	0	496	34	26	159	96	802	0	442	0	0	0
Initial Fut:	0	1589	399	26	1174	514	1239	0	882	0	0	0
User Adj:	1.00	1.00	0.00	1.00	1.00	0.00	1.00	1.00	1.00	1.00	1.00	1.00
PHF Adj:	1.00	1.00	0.00	1.00	1.00	0.00	1.00	1.00	1.00	1.00	1.00	1.00
PHF Volume:	0	1589	0	26	1174	0	1239	0	882	0	0	0
Reduct Vol:	0	0	0	0	0	0	0	0	0	0	0	0
Reduced Vol:	0	1589	0	26	1174	0	1239	0	882	0	0	0
PCE Adj:	1.00	1.00	0.00	1.00	1.00	0.00	1.00	1.00	1.00	1.00	1.00	1.00
MLF Adj:	1.00	1.00	0.00	1.00	1.00	0.00	1.00	1.00	1.00	1.00	1.00	1.00
Final Volume:	0	1589	0	26	1174	0	1239	0	882	0	0	0
Saturation Flow Module:												
Sat/Lane:	1900	1900	1900	1900	1900	1900	1900	1900	1900	1900	1900	1900
Adjustment:	0.92	1.00	0.92	0.95	0.99	0.92	0.83	1.00	0.83	0.92	1.00	0.92
Lanes:	0.00	2.00	1.00	0.09	3.91	1.00	2.00	0.00	2.00	0.00	0.00	0.00
Final Sat.:	0	3800	1750	162	7337	1750	3150	0	3150	0	0	0
Capacity Analysis Module:												
Vol/Sat:	0.00	0.42	0.00	0.16	0.16	0.00	0.39	0.00	0.28	0.00	0.00	0.00
Crit Moves:	****						****					
Green Time:	0.0	57.2	0.0	57.2	57.2	0.0	53.8	0.0	53.8	0.0	0.0	0.0
Volume/Cap:	0.00	0.88	0.00	0.34	0.34	0.00	0.88	0.00	0.62	0.00	0.00	0.00
Delay/Veh:	0.0	33.5	0.0	19.6	19.6	0.0	36.6	0.0	26.2	0.0	0.0	0.0
User DelAdj:	1.00	1.00	1.00	1.00	1.00	1.00	1.00	1.00	1.00	1.00	1.00	1.00
AdjDel/Veh:	0.0	33.5	0.0	19.6	19.6	0.0	36.6	0.0	26.2	0.0	0.0	0.0
LOS by Move:	A	C-	A	B-	B-	A	D+	A	C	A	A	A
HCM2kAvgQ:	0	20	0	3	3	0	28	0	15	0	0	0

Note: Queue reported is the number of cars per lane.

Hamptons Apartment Complex TIA
 SJ15-1612
 Background AM

Level Of Service Computation Report
 2000 HCM Operations (Future Volume Alternative)
 Background PP AM

Intersection #9: Wolfe Road / I-280 SB Ramps

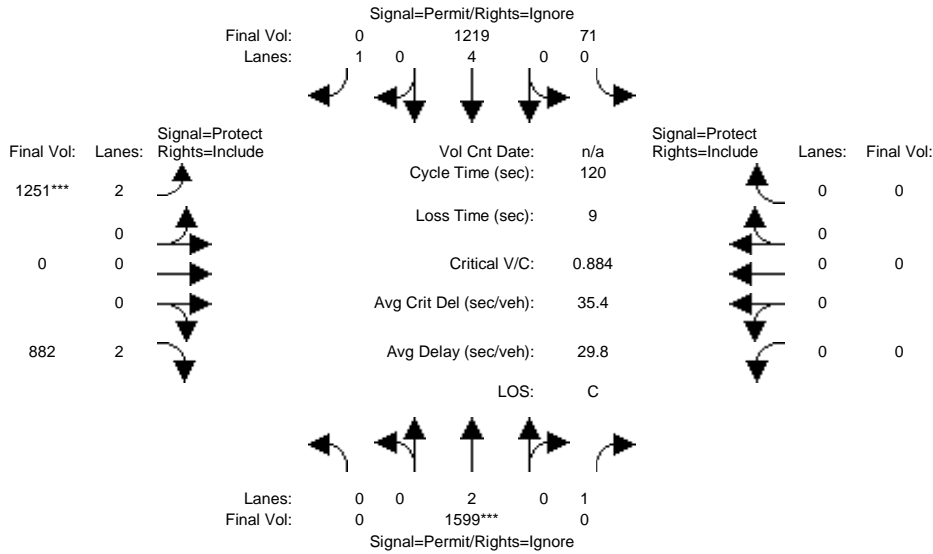

Street Name:	Wolfe Road						I-280 SB Ramps					
Approach:	North Bound			South Bound			East Bound			West Bound		
Movement:	L	T	R	L	T	R	L	T	R	L	T	R
Min. Green:	7	10	10	7	10	10	10	10	10	0	0	0
Y+R:	5.0	5.0	5.0	5.0	5.0	5.0	5.0	5.0	5.0	5.0	5.0	5.0
Volume Module:												
Base Vol:	0	1093	365	0	1015	418	437	0	440	0	0	0
Growth Adj:	1.00	1.00	1.00	1.00	1.00	1.00	1.00	1.00	1.00	1.00	1.00	1.00
Initial Bse:	0	1093	365	0	1015	418	437	0	440	0	0	0
Added Vol:	0	10	0	45	45	0	12	0	0	0	0	0
PasserByVol:	0	496	34	26	159	96	802	0	442	0	0	0
Initial Fut:	0	1599	399	71	1219	514	1251	0	882	0	0	0
User Adj:	1.00	1.00	0.00	1.00	1.00	0.00	1.00	1.00	1.00	1.00	1.00	1.00
PHF Adj:	1.00	1.00	0.00	1.00	1.00	0.00	1.00	1.00	1.00	1.00	1.00	1.00
PHF Volume:	0	1599	0	71	1219	0	1251	0	882	0	0	0
Reduct Vol:	0	0	0	0	0	0	0	0	0	0	0	0
Reduced Vol:	0	1599	0	71	1219	0	1251	0	882	0	0	0
PCE Adj:	1.00	1.00	0.00	1.00	1.00	0.00	1.00	1.00	1.00	1.00	1.00	1.00
MLF Adj:	1.00	1.00	0.00	1.00	1.00	0.00	1.00	1.00	1.00	1.00	1.00	1.00
Final Volume:	0	1599	0	71	1219	0	1251	0	882	0	0	0
Saturation Flow Module:												
Sat/Lane:	1900	1900	1900	1900	1900	1900	1900	1900	1900	1900	1900	1900
Adjustment:	0.92	1.00	0.92	0.95	0.99	0.92	0.83	1.00	0.83	0.92	1.00	0.92
Lanes:	0.00	2.00	1.00	0.23	3.77	1.00	2.00	0.00	2.00	0.00	0.00	0.00
Final Sat.:	0	3800	1750	413	7087	1750	3150	0	3150	0	0	0
Capacity Analysis Module:												
Vol/Sat:	0.00	0.42	0.00	0.17	0.17	0.00	0.40	0.00	0.28	0.00	0.00	0.00
Crit Moves:	****						****					
Green Time:	0.0	57.1	0.0	57.1	57.1	0.0	53.9	0.0	53.9	0.0	0.0	0.0
Volume/Cap:	0.00	0.88	0.00	0.36	0.36	0.00	0.88	0.00	0.62	0.00	0.00	0.00
Delay/Veh:	0.0	34.1	0.0	20.0	20.0	0.0	37.2	0.0	26.2	0.0	0.0	0.0
User DelAdj:	1.00	1.00	1.00	1.00	1.00	1.00	1.00	1.00	1.00	1.00	1.00	1.00
AdjDel/Veh:	0.0	34.1	0.0	20.0	20.0	0.0	37.2	0.0	26.2	0.0	0.0	0.0
LOS by Move:	A	C-	A	B-	B-	A	D+	A	C	A	A	A
HCM2kAvgQ:	0	21	0	3	3	0	28	0	15	0	0	0

Note: Queue reported is the number of cars per lane.

Hamptons Apartment Complex TIA
SJ15-1612
Background AM

Level Of Service Computation Report
2000 HCM Operations (Future Volume Alternative)
Background AM

Intersection #10: Wolfe Road / Vallco Parkway

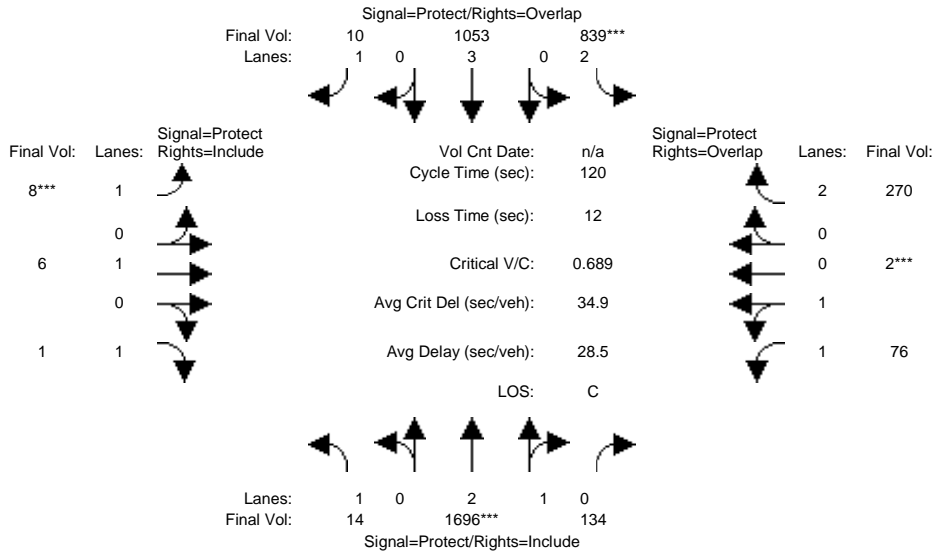

Street Name:	Wolfe Road						Vallco Parkway					
	North Bound			South Bound			East Bound			West Bound		
Approach:	North Bound			South Bound			East Bound			West Bound		
Movement:	L	T	R	L	T	R	L	T	R	L	T	R
Min. Green:	7	10	10	7	10	10	7	10	10	7	10	10
Y+R:	4.0	4.0	4.0	4.0	4.0	4.0	4.0	4.0	4.0	4.0	4.0	4.0

Volume Module:												
Base Vol:	14	1331	114	351	977	10	8	6	1	59	2	117
Growth Adj:	1.00	1.00	1.00	1.00	1.00	1.00	1.00	1.00	1.00	1.00	1.00	1.00
Initial Bse:	14	1331	114	351	977	10	8	6	1	59	2	117
Added Vol:	0	0	0	0	0	0	0	0	0	0	0	0
PasserByVol:	0	365	20	488	76	0	0	0	0	17	0	153
Initial Fut:	14	1696	134	839	1053	10	8	6	1	76	2	270
User Adj:	1.00	1.00	1.00	1.00	1.00	1.00	1.00	1.00	1.00	1.00	1.00	1.00
PHF Adj:	1.00	1.00	1.00	1.00	1.00	1.00	1.00	1.00	1.00	1.00	1.00	1.00
PHF Volume:	14	1696	134	839	1053	10	8	6	1	76	2	270
Reduct Vol:	0	0	0	0	0	0	0	0	0	0	0	0
Reduced Vol:	14	1696	134	839	1053	10	8	6	1	76	2	270
PCE Adj:	1.00	1.00	1.00	1.00	1.00	1.00	1.00	1.00	1.00	1.00	1.00	1.00
MLF Adj:	1.00	1.00	1.00	1.00	1.00	1.00	1.00	1.00	1.00	1.00	1.00	1.00
Final Volume:	14	1696	134	839	1053	10	8	6	1	76	2	270

Saturation Flow Module:												
Sat/Lane:	1900	1900	1900	1900	1900	1900	1900	1900	1900	1900	1900	1900
Adjustment:	0.92	0.99	0.95	0.83	1.00	0.92	0.92	1.00	0.92	0.93	0.95	0.83
Lanes:	1.00	2.77	0.23	2.00	3.00	1.00	1.00	1.00	1.00	1.95	0.05	2.00
Final Sat.:	1750	5189	410	3150	5700	1750	1750	1900	1750	3459	91	3150

Capacity Analysis Module:												
Vol/Sat:	0.01	0.33	0.33	0.27	0.18	0.01	0.00	0.00	0.00	0.02	0.02	0.09
Crit Moves:	****			****			****			****		
Green Time:	21.8	50.1	50.1	40.9	69.2	76.2	7.0	10.0	10.0	7.0	10.0	50.9
Volume/Cap:	0.04	0.78	0.78	0.78	0.32	0.01	0.08	0.04	0.01	0.38	0.26	0.20
Delay/Veh:	40.5	32.0	32.0	39.4	13.3	8.1	53.8	50.7	50.5	55.6	52.0	21.9
User DelAdj:	1.00	1.00	1.00	1.00	1.00	1.00	1.00	1.00	1.00	1.00	1.00	1.00
AdjDel/Veh:	40.5	32.0	32.0	39.4	13.3	8.1	53.8	50.7	50.5	55.6	52.0	21.9
LOS by Move:	D	C	C	D	B	A	D-	D	D	E+	D-	C+
HCM2kAvgQ:	0	19	19	17	6	0	0	0	0	1	1	4

Note: Queue reported is the number of cars per lane.

Hamptons Apartment Complex TIA
SJ15-1612
Background AM

Level Of Service Computation Report
2000 HCM Operations (Future Volume Alternative)
Background PP AM

Intersection #10: Wolfe Road / Vallco Parkway

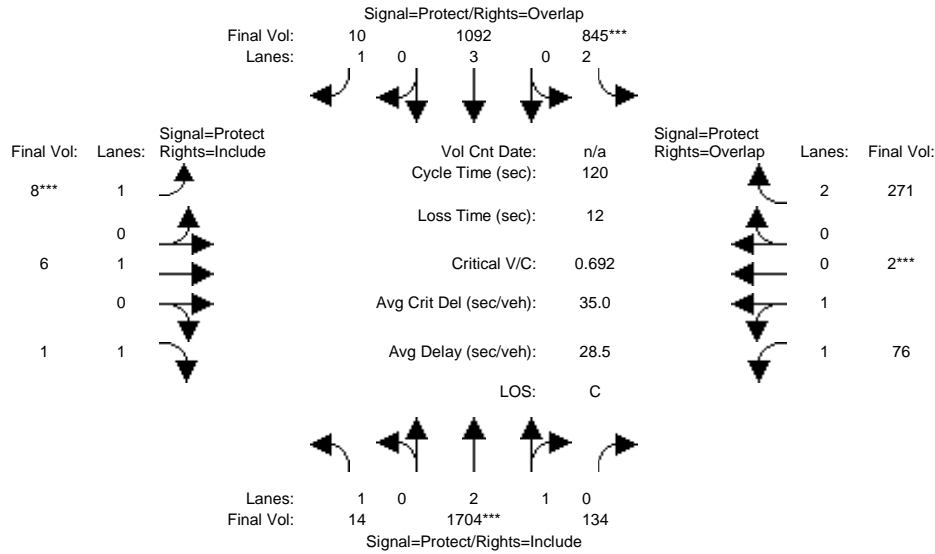

Street Name:	Wolfe Road						Vallco Parkway					
	North Bound			South Bound			East Bound			West Bound		
Approach:	North Bound			South Bound			East Bound			West Bound		
Movement:	L	T	R	L	T	R	L	T	R	L	T	R
Min. Green:	7	10	10	7	10	10	7	10	10	7	10	10
Y+R:	4.0	4.0	4.0	4.0	4.0	4.0	4.0	4.0	4.0	4.0	4.0	4.0

Volume Module:												
Base Vol:	14	1331	114	351	977	10	8	6	1	59	2	117
Growth Adj:	1.00	1.00	1.00	1.00	1.00	1.00	1.00	1.00	1.00	1.00	1.00	1.00
Initial Bse:	14	1331	114	351	977	10	8	6	1	59	2	117
Added Vol:	0	8	0	6	39	0	0	0	0	0	0	1
PasserByVol:	0	365	20	488	76	0	0	0	0	17	0	153
Initial Fut:	14	1704	134	845	1092	10	8	6	1	76	2	271
User Adj:	1.00	1.00	1.00	1.00	1.00	1.00	1.00	1.00	1.00	1.00	1.00	1.00
PHF Adj:	1.00	1.00	1.00	1.00	1.00	1.00	1.00	1.00	1.00	1.00	1.00	1.00
PHF Volume:	14	1704	134	845	1092	10	8	6	1	76	2	271
Reduct Vol:	0	0	0	0	0	0	0	0	0	0	0	0
Reduced Vol:	14	1704	134	845	1092	10	8	6	1	76	2	271
PCE Adj:	1.00	1.00	1.00	1.00	1.00	1.00	1.00	1.00	1.00	1.00	1.00	1.00
MLF Adj:	1.00	1.00	1.00	1.00	1.00	1.00	1.00	1.00	1.00	1.00	1.00	1.00
Final Volume:	14	1704	134	845	1092	10	8	6	1	76	2	271

Saturation Flow Module:												
Sat/Lane:	1900	1900	1900	1900	1900	1900	1900	1900	1900	1900	1900	1900
Adjustment:	0.92	0.99	0.95	0.83	1.00	0.92	0.92	1.00	0.92	0.93	0.95	0.83
Lanes:	1.00	2.77	0.23	2.00	3.00	1.00	1.00	1.00	1.00	1.95	0.05	2.00
Final Sat.:	1750	5191	408	3150	5700	1750	1750	1900	1750	3459	91	3150

Capacity Analysis Module:												
Vol/Sat:	0.01	0.33	0.33	0.27	0.19	0.01	0.00	0.00	0.00	0.02	0.02	0.09
Crit Moves:	****			****			****			****		
Green Time:	21.2	50.1	50.1	40.9	69.8	76.8	7.0	10.0	10.0	7.0	10.0	50.9
Volume/Cap:	0.05	0.79	0.79	0.79	0.33	0.01	0.08	0.04	0.01	0.38	0.26	0.20
Delay/Veh:	41.0	32.2	32.2	39.5	13.1	7.8	53.8	50.7	50.5	55.6	52.0	21.8
User DelAdj:	1.00	1.00	1.00	1.00	1.00	1.00	1.00	1.00	1.00	1.00	1.00	1.00
AdjDel/Veh:	41.0	32.2	32.2	39.5	13.1	7.8	53.8	50.7	50.5	55.6	52.0	21.8
LOS by Move:	D	C-	C-	D	B	A	D-	D	D	E+	D-	C+
HCM2kAvgQ:	0	19	19	17	7	0	0	0	0	1	1	4

Note: Queue reported is the number of cars per lane.

Hamptons Apartment Complex TIA
SJ15-1612
Background AM

Level Of Service Computation Report
2000 HCM Operations (Future Volume Alternative)
Background AM

Intersection #11: Wolfe Road / Stevens Creek Boulevard

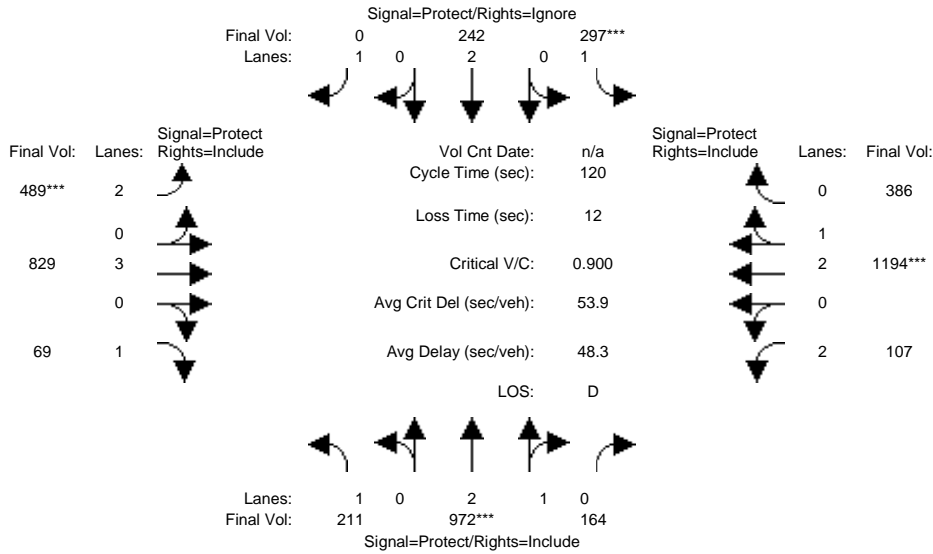

Street Name:	Wolfe Road						Stevens Creek Boulevard					
	North Bound			South Bound			East Bound			West Bound		
Approach:	North Bound			South Bound			East Bound			West Bound		
Movement:	L	T	R	L	T	R	L	T	R	L	T	R
Min. Green:	7	10	10	7	10	10	7	10	10	7	10	10
Y+R:	5.0	5.0	5.0	5.0	5.0	5.0	5.0	5.0	5.0	5.0	5.0	5.0

Volume Module:												
Base Vol:	211	913	122	238	230	536	389	541	66	81	1005	157
Growth Adj:	1.00	1.00	1.00	1.00	1.00	1.00	1.00	1.00	1.00	1.00	1.00	1.00
Initial Bse:	211	913	122	238	230	536	389	541	66	81	1005	157
Added Vol:	0	0	0	0	0	0	0	0	0	0	0	0
PasserByVol:	0	59	42	59	12	33	100	288	3	26	189	229
Initial Fut:	211	972	164	297	242	569	489	829	69	107	1194	386
User Adj:	1.00	1.00	1.00	1.00	1.00	0.00	1.00	1.00	1.00	1.00	1.00	1.00
PHF Adj:	1.00	1.00	1.00	1.00	1.00	0.00	1.00	1.00	1.00	1.00	1.00	1.00
PHF Volume:	211	972	164	297	242	0	489	829	69	107	1194	386
Reduct Vol:	0	0	0	0	0	0	0	0	0	0	0	0
Reduced Vol:	211	972	164	297	242	0	489	829	69	107	1194	386
PCE Adj:	1.00	1.00	1.00	1.00	1.00	0.00	1.00	1.00	1.00	1.00	1.00	1.00
MLF Adj:	1.00	1.00	1.00	1.00	1.00	0.00	1.00	1.00	1.00	1.00	1.00	1.00
Final Volume:	211	972	164	297	242	0	489	829	69	107	1194	386

Saturation Flow Module:												
Sat/Lane:	1900	1900	1900	1900	1900	1900	1900	1900	1900	1900	1900	1900
Adjustment:	0.92	0.99	0.95	0.92	1.00	0.92	0.83	1.00	0.92	0.83	0.99	0.95
Lanes:	1.00	2.55	0.45	1.00	2.00	1.00	2.00	3.00	1.00	2.00	2.24	0.76
Final Sat.:	1750	4790	808	1750	3800	1750	3150	5700	1750	3150	4230	1368

Capacity Analysis Module:												
Vol/Sat:	0.12	0.20	0.20	0.17	0.06	0.00	0.16	0.15	0.04	0.03	0.28	0.28
Crit Moves:	****			****			****			****		
Green Time:	29.4	27.0	27.0	22.6	20.3	0.0	20.7	41.6	41.6	16.7	37.6	37.6
Volume/Cap:	0.49	0.90	0.90	0.90	0.38	0.00	0.90	0.42	0.11	0.24	0.90	0.90
Delay/Veh:	39.8	54.2	54.2	73.7	44.6	0.0	66.6	30.1	26.7	46.3	46.1	46.1
User DelAdj:	1.00	1.00	1.00	1.00	1.00	1.00	1.00	1.00	1.00	1.00	1.00	1.00
AdjDel/Veh:	39.8	54.2	54.2	73.7	44.6	0.0	66.6	30.1	26.7	46.3	46.1	46.1
LOS by Move:	D	D-	D-	E	D	A	E	C	C	D	D	D
HCM2kAvgQ:	7	17	17	13	4	0	12	6	1	2	19	19

Note: Queue reported is the number of cars per lane.

Hamptons Apartment Complex TIA
SJ15-1612
Background AM

Level Of Service Computation Report
2000 HCM Operations (Future Volume Alternative)
Background PP AM

Intersection #11: Wolfe Road / Stevens Creek Boulevard

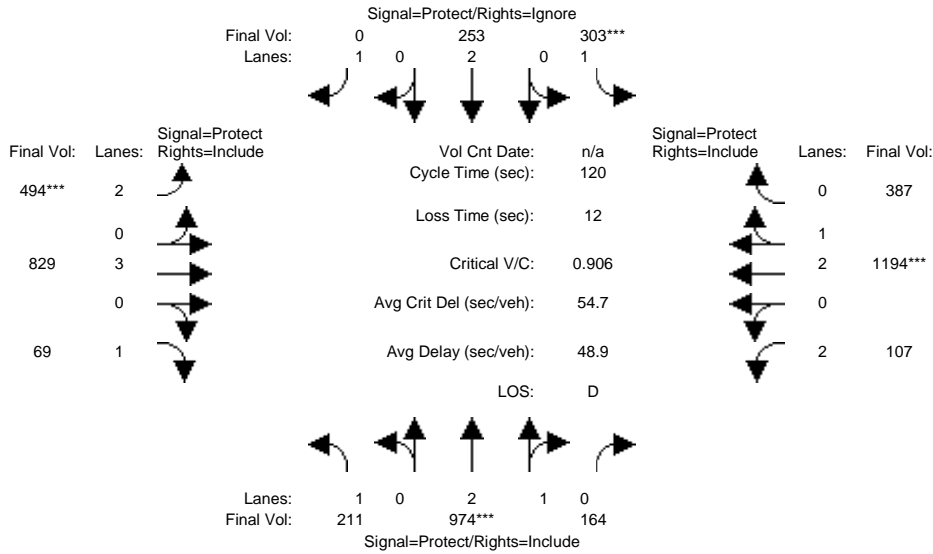

Street Name:	Wolfe Road						Stevens Creek Boulevard					
	North Bound			South Bound			East Bound			West Bound		
Approach:												
Movement:	L	T	R	L	T	R	L	T	R	L	T	R
Min. Green:	7	10	10	7	10	10	7	10	10	7	10	10
Y+R:	5.0	5.0	5.0	5.0	5.0	5.0	5.0	5.0	5.0	5.0	5.0	5.0

Volume Module:												
Base Vol:	211	913	122	238	230	536	389	541	66	81	1005	157
Growth Adj:	1.00	1.00	1.00	1.00	1.00	1.00	1.00	1.00	1.00	1.00	1.00	1.00
Initial Bse:	211	913	122	238	230	536	389	541	66	81	1005	157
Added Vol:	0	2	0	6	11	22	5	0	0	0	0	1
PasserByVol:	0	59	42	59	12	33	100	288	3	26	189	229
Initial Fut:	211	974	164	303	253	591	494	829	69	107	1194	387
User Adj:	1.00	1.00	1.00	1.00	1.00	0.00	1.00	1.00	1.00	1.00	1.00	1.00
PHF Adj:	1.00	1.00	1.00	1.00	1.00	0.00	1.00	1.00	1.00	1.00	1.00	1.00
PHF Volume:	211	974	164	303	253	0	494	829	69	107	1194	387
Reduct Vol:	0	0	0	0	0	0	0	0	0	0	0	0
Reduced Vol:	211	974	164	303	253	0	494	829	69	107	1194	387
PCE Adj:	1.00	1.00	1.00	1.00	1.00	0.00	1.00	1.00	1.00	1.00	1.00	1.00
MLF Adj:	1.00	1.00	1.00	1.00	1.00	0.00	1.00	1.00	1.00	1.00	1.00	1.00
Final Volume:	211	974	164	303	253	0	494	829	69	107	1194	387

Saturation Flow Module:												
Sat/Lane:	1900	1900	1900	1900	1900	1900	1900	1900	1900	1900	1900	1900
Adjustment:	0.92	0.99	0.95	0.92	1.00	0.92	0.83	1.00	0.92	0.83	0.99	0.95
Lanes:	1.00	2.55	0.45	1.00	2.00	1.00	2.00	3.00	1.00	2.00	2.24	0.76
Final Sat.:	1750	4792	807	1750	3800	1750	3150	5700	1750	3150	4227	1370

Capacity Analysis Module:												
Vol/Sat:	0.12	0.20	0.20	0.17	0.07	0.00	0.16	0.15	0.04	0.03	0.28	0.28
Crit Moves:	****			****			****			****		
Green Time:	29.5	26.9	26.9	22.9	20.4	0.0	20.8	41.5	41.5	16.6	37.4	37.4
Volume/Cap:	0.49	0.91	0.91	0.91	0.39	0.00	0.91	0.42	0.11	0.24	0.91	0.91
Delay/Veh:	39.7	54.9	54.9	74.5	44.7	0.0	67.4	30.2	26.8	46.4	46.9	46.9
User DelAdj:	1.00	1.00	1.00	1.00	1.00	1.00	1.00	1.00	1.00	1.00	1.00	1.00
AdjDel/Veh:	39.7	54.9	54.9	74.5	44.7	0.0	67.4	30.2	26.8	46.4	46.9	46.9
LOS by Move:	D	D-	D-	E	D	A	E	C	C	D	D	D
HCM2kAvgQ:	7	17	17	13	4	0	12	6	1	2	20	20

Note: Queue reported is the number of cars per lane.

Hamptons Apartment Complex TIA
SJ15-1612
Background AM

Level Of Service Computation Report
2000 HCM Operations (Future Volume Alternative)
Background AM

Intersection #12: De Anza Boulevard / Stevens Creek Boulevard

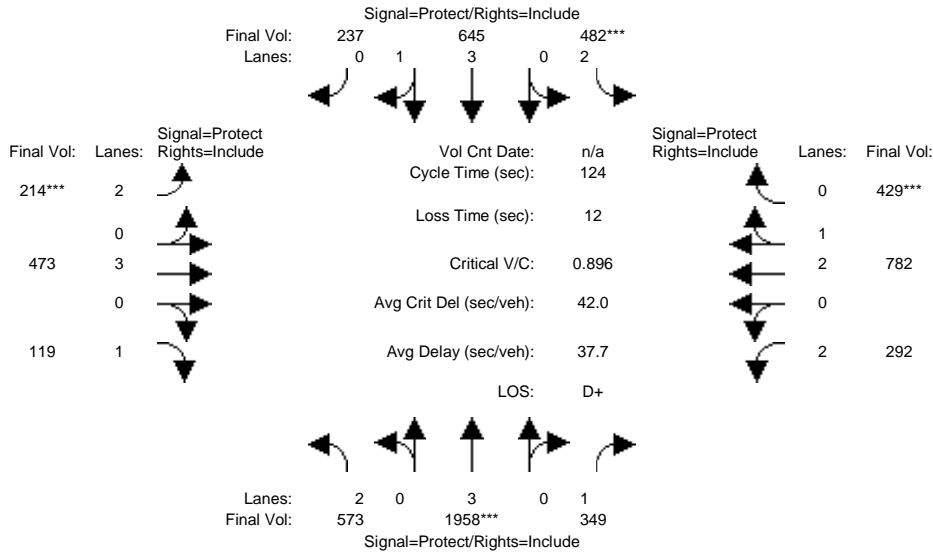

Street Name:	De Anza Boulevard						Stevens Creek Boulevard					
	North Bound			South Bound			East Bound			West Bound		
Approach:	North Bound			South Bound			East Bound			West Bound		
Movement:	L	T	R	L	T	R	L	T	R	L	T	R
Min. Green:	7	10	10	7	10	10	7	10	10	7	10	10
Y+R:	5.0	5.0	5.0	5.0	5.0	5.0	5.0	5.0	5.0	5.0	5.0	5.0

Volume Module:												
Base Vol:	564	1728	195	404	574	226	189	379	114	248	723	323
Growth Adj:	1.00	1.00	1.00	1.00	1.00	1.00	1.00	1.00	1.00	1.00	1.00	1.00
Initial Bse:	564	1728	195	404	574	226	189	379	114	248	723	323
Added Vol:	0	0	0	0	0	0	0	0	0	0	0	0
PasserByVol:	9	230	154	78	71	11	25	94	5	44	59	106
Initial Fut:	573	1958	349	482	645	237	214	473	119	292	782	429
User Adj:	1.00	1.00	1.00	1.00	1.00	1.00	1.00	1.00	1.00	1.00	1.00	1.00
PHF Adj:	1.00	1.00	1.00	1.00	1.00	1.00	1.00	1.00	1.00	1.00	1.00	1.00
PHF Volume:	573	1958	349	482	645	237	214	473	119	292	782	429
Reduct Vol:	0	0	0	0	0	0	0	0	0	0	0	0
Reduced Vol:	573	1958	349	482	645	237	214	473	119	292	782	429
PCE Adj:	1.00	1.00	1.00	1.00	1.00	1.00	1.00	1.00	1.00	1.00	1.00	1.00
MLF Adj:	1.00	1.00	1.00	1.00	1.00	1.00	1.00	1.00	1.00	1.00	1.00	1.00
Final Volume:	573	1958	349	482	645	237	214	473	119	292	782	429

Saturation Flow Module:												
Sat/Lane:	1900	1900	1900	1900	1900	1900	1900	1900	1900	1900	1900	1900
Adjustment:	0.83	1.00	0.92	0.83	1.00	0.92	0.83	1.00	0.92	0.83	1.00	0.92
Lanes:	2.00	3.00	1.00	2.00	3.00	1.00	2.00	3.00	1.00	2.00	2.00	1.00
Final Sat.:	3150	5700	1750	3150	5700	1750	3150	5700	1750	3150	3800	1750

Capacity Analysis Module:												
Vol/Sat:	0.18	0.34	0.20	0.15	0.11	0.14	0.07	0.08	0.07	0.09	0.21	0.25
Crit Moves:	****			****			****			****		
Green Time:	39.4	47.5	47.5	21.2	29.3	29.3	9.4	20.5	20.5	22.9	33.9	33.9
Volume/Cap:	0.57	0.90	0.52	0.90	0.48	0.57	0.90	0.50	0.41	0.50	0.75	0.90
Delay/Veh:	25.2	26.4	18.0	61.0	32.5	33.7	89.0	47.6	47.3	46.2	43.3	51.5
User DelAdj:	1.00	1.00	1.00	1.00	1.00	1.00	1.00	1.00	1.00	1.00	1.00	1.00
AdjDel/Veh:	25.2	26.4	18.0	61.0	32.5	33.7	89.0	47.6	47.3	46.2	43.3	51.5
LOS by Move:	C	C	B	E	C-	C-	F	D	D	D	D	D-
HCM2kAvgQ:	9	24	8	14	6	8	8	6	4	5	12	16

Note: Queue reported is the number of cars per lane.

Hamptons Apartment Complex TIA
 SJ15-1612
 Background AM

Level Of Service Computation Report
 2000 HCM Operations (Future Volume Alternative)
 Background PP AM

Intersection #12: De Anza Boulevard / Stevens Creek Boulevard

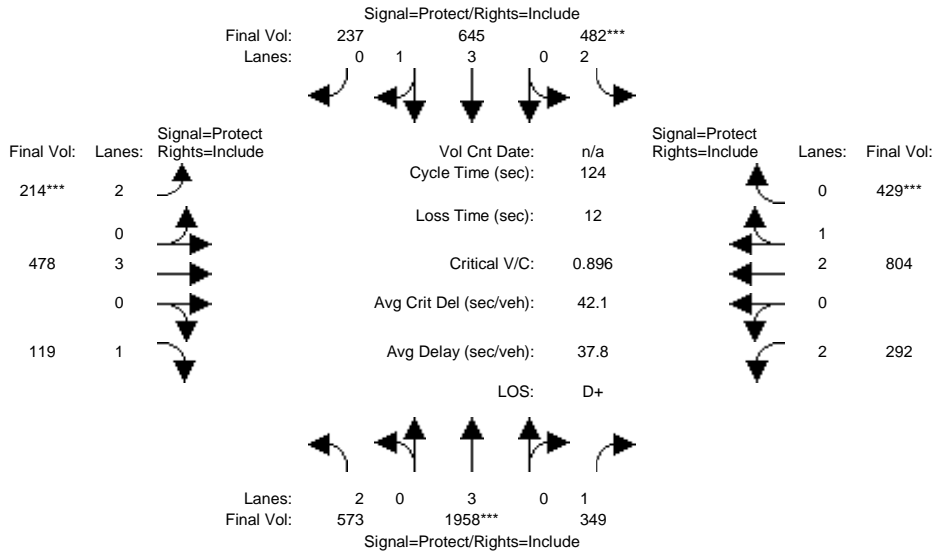

Street Name:	De Anza Boulevard						Stevens Creek Boulevard					
	North Bound			South Bound			East Bound			West Bound		
Approach:	North Bound			South Bound			East Bound			West Bound		
Movement:	L	T	R	L	T	R	L	T	R	L	T	R
Min. Green:	7	10	10	7	10	10	7	10	10	7	10	10
Y+R:	5.0	5.0	5.0	5.0	5.0	5.0	5.0	5.0	5.0	5.0	5.0	5.0

Volume Module:												
Base Vol:	564	1728	195	404	574	226	189	379	114	248	723	323
Growth Adj:	1.00	1.00	1.00	1.00	1.00	1.00	1.00	1.00	1.00	1.00	1.00	1.00
Initial Bse:	564	1728	195	404	574	226	189	379	114	248	723	323
Added Vol:	0	0	0	0	0	0	0	5	0	0	22	0
PasserByVol:	9	230	154	78	71	11	25	94	5	44	59	106
Initial Fut:	573	1958	349	482	645	237	214	478	119	292	804	429
User Adj:	1.00	1.00	1.00	1.00	1.00	1.00	1.00	1.00	1.00	1.00	1.00	1.00
PHF Adj:	1.00	1.00	1.00	1.00	1.00	1.00	1.00	1.00	1.00	1.00	1.00	1.00
PHF Volume:	573	1958	349	482	645	237	214	478	119	292	804	429
Reduct Vol:	0	0	0	0	0	0	0	0	0	0	0	0
Reduced Vol:	573	1958	349	482	645	237	214	478	119	292	804	429
PCE Adj:	1.00	1.00	1.00	1.00	1.00	1.00	1.00	1.00	1.00	1.00	1.00	1.00
MLF Adj:	1.00	1.00	1.00	1.00	1.00	1.00	1.00	1.00	1.00	1.00	1.00	1.00
Final Volume:	573	1958	349	482	645	237	214	478	119	292	804	429

Saturation Flow Module:												
Sat/Lane:	1900	1900	1900	1900	1900	1900	1900	1900	1900	1900	1900	1900
Adjustment:	0.83	1.00	0.92	0.83	1.00	0.92	0.83	1.00	0.92	0.83	1.00	0.92
Lanes:	2.00	3.00	1.00	2.00	3.00	1.00	2.00	3.00	1.00	2.00	2.00	1.00
Final Sat.:	3150	5700	1750	3150	5700	1750	3150	5700	1750	3150	3800	1750

Capacity Analysis Module:												
Vol/Sat:	0.18	0.34	0.20	0.15	0.11	0.14	0.07	0.08	0.07	0.09	0.21	0.25
Crit Moves:	****			****			****			****		
Green Time:	39.4	47.5	47.5	21.2	29.3	29.3	9.4	20.6	20.6	22.7	33.9	33.9
Volume/Cap:	0.57	0.90	0.52	0.90	0.48	0.57	0.90	0.51	0.41	0.51	0.77	0.90
Delay/Veh:	25.2	26.4	18.0	61.0	32.5	33.7	89.0	47.5	47.2	46.3	43.9	51.4
User DelAdj:	1.00	1.00	1.00	1.00	1.00	1.00	1.00	1.00	1.00	1.00	1.00	1.00
AdjDel/Veh:	25.2	26.4	18.0	61.0	32.5	33.7	89.0	47.5	47.2	46.3	43.9	51.4
LOS by Move:	C	C	B	E	C-	C-	F	D	D	D	D	D-
HCM2kAvgQ:	9	24	8	14	6	8	8	6	4	5	13	16

Note: Queue reported is the number of cars per lane.

Hamptons Apartment Complex TIA
SJ15-1612
Background AM

Level Of Service Computation Report
2000 HCM Operations (Future Volume Alternative)
Background AM

Intersection #13: Tantau Avenue / Homestead Road

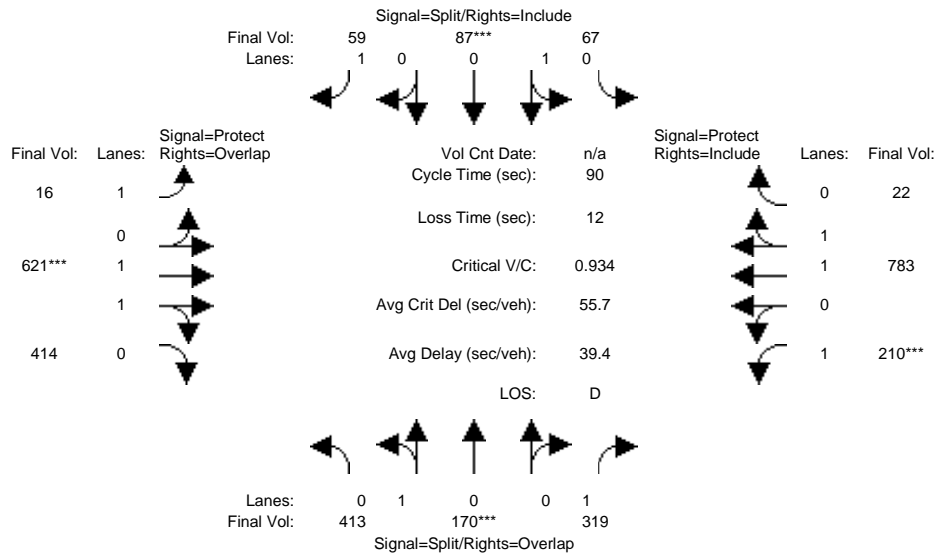

Street Name:	Tantau Avenue						Homestead Road					
Approach:	North Bound			South Bound			East Bound			West Bound		
Movement:	L	T	R	L	T	R	L	T	R	L	T	R
Min. Green:	7	10	10	7	10	10	7	10	10	7	10	10
Y+R:	4.0	4.0	4.0	4.0	4.0	4.0	4.0	4.0	4.0	4.0	4.0	4.0

Volume Module:	Tantau Avenue North			Tantau Avenue South			Homestead Road East			Homestead Road West		
Base Vol:	236	162	291	66	62	50	14	594	167	121	694	19
Growth Adj:	1.00	1.00	1.00	1.00	1.00	1.00	1.00	1.00	1.00	1.00	1.00	1.00
Initial Bse:	236	162	291	66	62	50	14	594	167	121	694	19
Added Vol:	0	0	0	0	0	0	0	0	0	0	0	0
PasserByVol:	177	8	28	1	25	9	2	27	247	89	89	3
Initial Fut:	413	170	319	67	87	59	16	621	414	210	783	22
User Adj:	1.00	1.00	1.00	1.00	1.00	1.00	1.00	1.00	1.00	1.00	1.00	1.00
PHF Adj:	1.00	1.00	1.00	1.00	1.00	1.00	1.00	1.00	1.00	1.00	1.00	1.00
PHF Volume:	413	170	319	67	87	59	16	621	414	210	783	22
Reduct Vol:	0	0	0	0	0	0	0	0	0	0	0	0
Reduced Vol:	413	170	319	67	87	59	16	621	414	210	783	22
PCE Adj:	1.00	1.00	1.00	1.00	1.00	1.00	1.00	1.00	1.00	1.00	1.00	1.00
MLF Adj:	1.00	1.00	1.00	1.00	1.00	1.00	1.00	1.00	1.00	1.00	1.00	1.00
Final Volume:	413	170	319	67	87	59	16	621	414	210	783	22

Saturation Flow Module:	Tantau Avenue North			Tantau Avenue South			Homestead Road East			Homestead Road West		
Sat/Lane:	1900	1900	1900	1900	1900	1900	1900	1900	1900	1900	1900	1900
Adjustment:	0.95	0.95	0.92	0.95	0.95	0.92	0.92	0.99	0.95	0.92	0.97	0.95
Lanes:	0.71	0.29	1.00	0.44	0.56	1.00	1.00	1.18	0.82	1.00	1.94	0.06
Final Sat.:	1275	525	1750	783	1017	1750	1750	2219	1479	1750	3599	101

Capacity Analysis Module:	Tantau Avenue North			Tantau Avenue South			Homestead Road East			Homestead Road West		
Vol/Sat:	0.32	0.32	0.18	0.09	0.09	0.03	0.01	0.28	0.28	0.12	0.22	0.22
Crit Moves:	****			****			****			****		
Green Time:	30.4	30.4	41.7	10.0	10.0	10.0	9.9	26.3	56.7	11.3	27.7	27.7
Volume/Cap:	0.96	0.96	0.39	0.77	0.77	0.30	0.08	0.96	0.44	0.96	0.71	0.71
Delay/Veh:	55.4	55.4	16.2	55.5	55.5	37.7	36.2	49.4	8.7	87.9	29.7	29.7
User DelAdj:	1.00	1.00	1.00	1.00	1.00	1.00	1.00	1.00	1.00	1.00	1.00	1.00
AdjDel/Veh:	55.4	55.4	16.2	55.5	55.5	37.7	36.2	49.4	8.7	87.9	29.7	29.7
LOS by Move:	E+	E+	B	E+	E+	D+	D+	D	A	F	C	C
HCM2kAvgQ:	22	22	6	6	6	2	0	17	7	6	9	9

Note: Queue reported is the number of cars per lane.

Hamptons Apartment Complex TIA
SJ15-1612
Background AM

Level Of Service Computation Report
2000 HCM Operations (Future Volume Alternative)
Background PP AM

Intersection #13: Tantau Avenue / Homestead Road

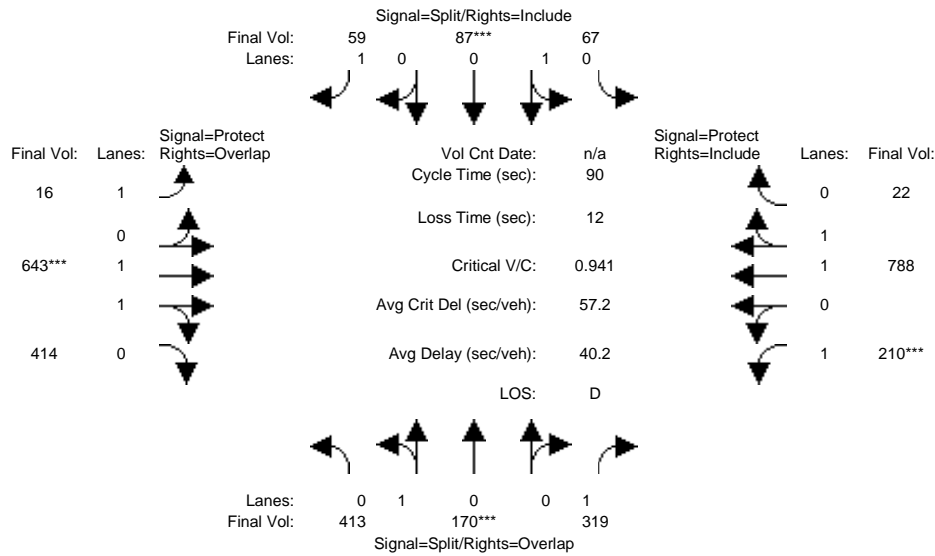

Street Name:	Tantau Avenue						Homestead Road					
Approach:	North Bound			South Bound			East Bound			West Bound		
Movement:	L	T	R	L	T	R	L	T	R	L	T	R
Min. Green:	7	10	10	7	10	10	7	10	10	7	10	10
Y+R:	4.0	4.0	4.0	4.0	4.0	4.0	4.0	4.0	4.0	4.0	4.0	4.0

Volume Module:	Tantau Avenue NB			Tantau Avenue SB			Homestead Road EB			Homestead Road WB		
Base Vol:	236	162	291	66	62	50	14	594	167	121	694	19
Growth Adj:	1.00	1.00	1.00	1.00	1.00	1.00	1.00	1.00	1.00	1.00	1.00	1.00
Initial Bse:	236	162	291	66	62	50	14	594	167	121	694	19
Added Vol:	0	0	0	0	0	0	0	22	0	0	5	0
PasserByVol:	177	8	28	1	25	9	2	27	247	89	89	3
Initial Fut:	413	170	319	67	87	59	16	643	414	210	788	22
User Adj:	1.00	1.00	1.00	1.00	1.00	1.00	1.00	1.00	1.00	1.00	1.00	1.00
PHF Adj:	1.00	1.00	1.00	1.00	1.00	1.00	1.00	1.00	1.00	1.00	1.00	1.00
PHF Volume:	413	170	319	67	87	59	16	643	414	210	788	22
Reduct Vol:	0	0	0	0	0	0	0	0	0	0	0	0
Reduced Vol:	413	170	319	67	87	59	16	643	414	210	788	22
PCE Adj:	1.00	1.00	1.00	1.00	1.00	1.00	1.00	1.00	1.00	1.00	1.00	1.00
MLF Adj:	1.00	1.00	1.00	1.00	1.00	1.00	1.00	1.00	1.00	1.00	1.00	1.00
Final Volume:	413	170	319	67	87	59	16	643	414	210	788	22

Saturation Flow Module:	Tantau Avenue NB			Tantau Avenue SB			Homestead Road EB			Homestead Road WB		
Sat/Lane:	1900	1900	1900	1900	1900	1900	1900	1900	1900	1900	1900	1900
Adjustment:	0.95	0.95	0.92	0.95	0.95	0.92	0.92	0.99	0.95	0.92	0.97	0.95
Lanes:	0.71	0.29	1.00	0.44	0.56	1.00	1.00	1.20	0.80	1.00	1.94	0.06
Final Sat.:	1275	525	1750	783	1017	1750	1750	2250	1449	1750	3599	100

Capacity Analysis Module:	Tantau Avenue NB			Tantau Avenue SB			Homestead Road EB			Homestead Road WB		
Vol/Sat:	0.32	0.32	0.18	0.09	0.09	0.03	0.01	0.29	0.29	0.12	0.22	0.22
Crit Moves:	****			****			****			****		
Green Time:	30.2	30.2	41.4	10.0	10.0	10.0	9.9	26.6	56.8	11.2	27.9	27.9
Volume/Cap:	0.97	0.97	0.40	0.77	0.77	0.30	0.08	0.97	0.45	0.97	0.71	0.71
Delay/Veh:	57.5	57.5	16.4	55.5	55.5	37.7	36.1	50.6	8.7	90.3	29.5	29.5
User DelAdj:	1.00	1.00	1.00	1.00	1.00	1.00	1.00	1.00	1.00	1.00	1.00	1.00
AdjDel/Veh:	57.5	57.5	16.4	55.5	55.5	37.7	36.1	50.6	8.7	90.3	29.5	29.5
LOS by Move:	E+	E+	B	E+	E+	D+	D+	D	A	F	C	C
HCM2kAvgQ:	23	23	6	6	6	2	0	18	8	7	9	9

Note: Queue reported is the number of cars per lane.

Hamptons Apartment Complex TIA
SJ15-1612
Background AM

Level Of Service Computation Report
2000 HCM Operations (Future Volume Alternative)
Background AM

Intersection #14: Tantau Avenue / Vallco Parkway

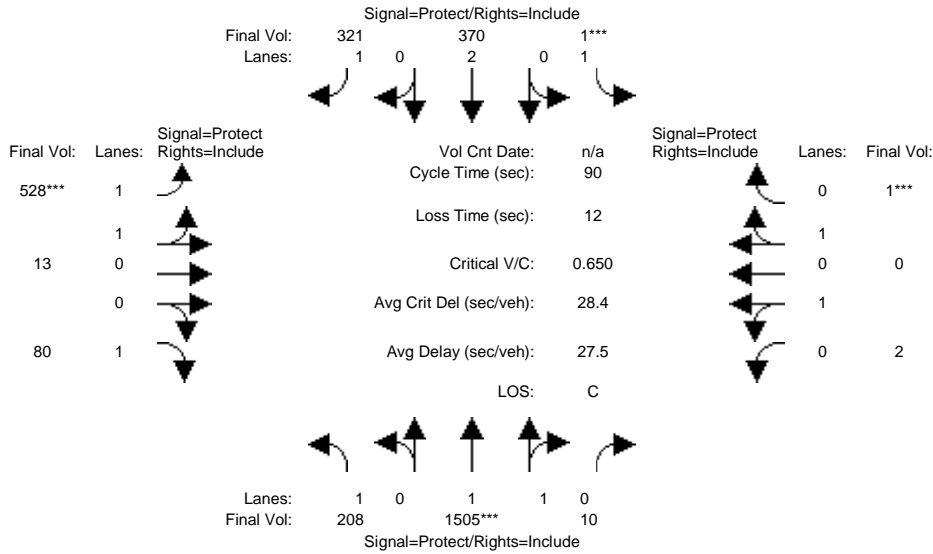

Street Name:	Tantau Avenue						Vallco Parkway					
	North Bound			South Bound			East Bound			West Bound		
Approach:	North Bound			South Bound			East Bound			West Bound		
Movement:	L	T	R	L	T	R	L	T	R	L	T	R
Min. Green:	7	10	10	7	10	10	7	10	10	7	10	10
Y+R:	4.0	4.0	4.0	4.0	4.0	4.0	4.0	4.0	4.0	4.0	4.0	4.0

Volume Module:												
Base Vol:	141	543	10	1	234	203	126	13	19	2	0	1
Growth Adj:	1.00	1.00	1.00	1.00	1.00	1.00	1.00	1.00	1.00	1.00	1.00	1.00
Initial Bse:	141	543	10	1	234	203	126	13	19	2	0	1
Added Vol:	0	0	0	0	0	0	0	0	0	0	0	0
PasserByVol:	67	962	0	0	136	118	402	0	61	0	0	0
Initial Fut:	208	1505	10	1	370	321	528	13	80	2	0	1
User Adj:	1.00	1.00	1.00	1.00	1.00	1.00	1.00	1.00	1.00	1.00	1.00	1.00
PHF Adj:	1.00	1.00	1.00	1.00	1.00	1.00	1.00	1.00	1.00	1.00	1.00	1.00
PHF Volume:	208	1505	10	1	370	321	528	13	80	2	0	1
Reduct Vol:	0	0	0	0	0	0	0	0	0	0	0	0
Reduced Vol:	208	1505	10	1	370	321	528	13	80	2	0	1
PCE Adj:	1.00	1.00	1.00	1.00	1.00	1.00	1.00	1.00	1.00	1.00	1.00	1.00
MLF Adj:	1.00	1.00	1.00	1.00	1.00	1.00	1.00	1.00	1.00	1.00	1.00	1.00
Final Volume:	208	1505	10	1	370	321	528	13	80	2	0	1

Saturation Flow Module:												
Sat/Lane:	1900	1900	1900	1900	1900	1900	1900	1900	1900	1900	1900	1900
Adjustment:	0.92	0.97	0.95	0.92	1.00	0.92	0.93	0.95	0.92	0.95	1.00	0.95
Lanes:	1.00	1.99	0.01	1.00	2.00	1.00	1.95	0.05	1.00	1.00	0.00	1.00
Final Sat.:	1750	3676	24	1750	3800	1750	3465	85	1750	1800	0	1800

Capacity Analysis Module:												
Vol/Sat:	0.12	0.41	0.41	0.00	0.10	0.18	0.15	0.15	0.05	0.00	0.00	0.00
Crit Moves:	****			****			****			****		
Green Time:	20.2	44.5	44.5	7.0	31.2	31.2	16.5	17.6	17.6	9.0	0.0	10.0
Volume/Cap:	0.53	0.83	0.83	0.01	0.28	0.53	0.83	0.78	0.23	0.01	0.00	0.01
Delay/Veh:	32.0	22.8	22.8	38.3	21.4	24.4	44.1	40.1	30.9	36.5	0.0	35.6
User DelAdj:	1.00	1.00	1.00	1.00	1.00	1.00	1.00	1.00	1.00	1.00	1.00	1.00
AdjDel/Veh:	32.0	22.8	22.8	38.3	21.4	24.4	44.1	40.1	30.9	36.5	0.0	35.6
LOS by Move:	C-	C+	C+	D+	C+	C	D	D	C	D+	A	D+
HCM2kAvgQ:	5	17	17	0	4	8	8	8	2	0	0	0

Note: Queue reported is the number of cars per lane.

Hamptons Apartment Complex TIA
SJ15-1612
Background AM

Level Of Service Computation Report
2000 HCM Operations (Future Volume Alternative)
Background PP AM

Intersection #14: Tantau Avenue / Vallco Parkway

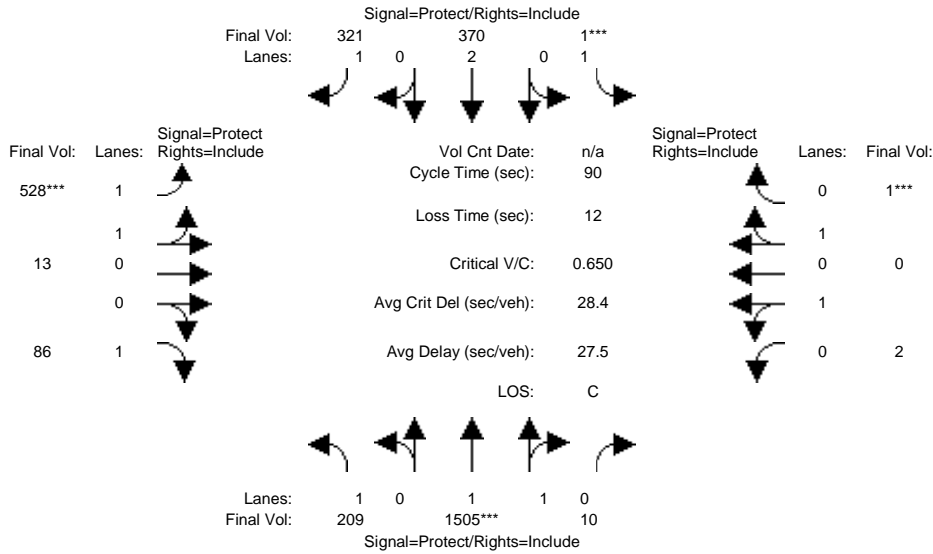

Street Name:	Tantau Avenue						Vallco Parkway					
	North Bound			South Bound			East Bound			West Bound		
Approach:												
Movement:	L	T	R	L	T	R	L	T	R	L	T	R
Min. Green:	7	10	10	7	10	10	7	10	10	7	10	10
Y+R:	4.0	4.0	4.0	4.0	4.0	4.0	4.0	4.0	4.0	4.0	4.0	4.0

Volume Module:												
Base Vol:	141	543	10	1	234	203	126	13	19	2	0	1
Growth Adj:	1.00	1.00	1.00	1.00	1.00	1.00	1.00	1.00	1.00	1.00	1.00	1.00
Initial Bse:	141	543	10	1	234	203	126	13	19	2	0	1
Added Vol:	1	0	0	0	0	0	0	0	6	0	0	0
PasserByVol:	67	962	0	0	136	118	402	0	61	0	0	0
Initial Fut:	209	1505	10	1	370	321	528	13	86	2	0	1
User Adj:	1.00	1.00	1.00	1.00	1.00	1.00	1.00	1.00	1.00	1.00	1.00	1.00
PHF Adj:	1.00	1.00	1.00	1.00	1.00	1.00	1.00	1.00	1.00	1.00	1.00	1.00
PHF Volume:	209	1505	10	1	370	321	528	13	86	2	0	1
Reduct Vol:	0	0	0	0	0	0	0	0	0	0	0	0
Reduced Vol:	209	1505	10	1	370	321	528	13	86	2	0	1
PCE Adj:	1.00	1.00	1.00	1.00	1.00	1.00	1.00	1.00	1.00	1.00	1.00	1.00
MLF Adj:	1.00	1.00	1.00	1.00	1.00	1.00	1.00	1.00	1.00	1.00	1.00	1.00
Final Volume:	209	1505	10	1	370	321	528	13	86	2	0	1

Saturation Flow Module:												
Sat/Lane:	1900	1900	1900	1900	1900	1900	1900	1900	1900	1900	1900	1900
Adjustment:	0.92	0.97	0.95	0.92	1.00	0.92	0.93	0.95	0.92	0.95	1.00	0.95
Lanes:	1.00	1.99	0.01	1.00	2.00	1.00	1.95	0.05	1.00	1.00	0.00	1.00
Final Sat.:	1750	3676	24	1750	3800	1750	3465	85	1750	1800	0	1800

Capacity Analysis Module:												
Vol/Sat:	0.12	0.41	0.41	0.00	0.10	0.18	0.15	0.15	0.05	0.00	0.00	0.00
Crit Moves:	****			****			****			****		
Green Time:	20.3	44.5	44.5	7.0	31.2	31.2	16.5	17.6	17.6	9.0	0.0	10.0
Volume/Cap:	0.53	0.83	0.83	0.01	0.28	0.53	0.83	0.78	0.25	0.01	0.00	0.01
Delay/Veh:	32.0	22.8	22.8	38.3	21.4	24.4	44.1	40.1	31.0	36.5	0.0	35.6
User DelAdj:	1.00	1.00	1.00	1.00	1.00	1.00	1.00	1.00	1.00	1.00	1.00	1.00
AdjDel/Veh:	32.0	22.8	22.8	38.3	21.4	24.4	44.1	40.1	31.0	36.5	0.0	35.6
LOS by Move:	C-	C+	C+	D+	C+	C	D	D	C	D+	A	D+
HCM2kAvgQ:	5	17	17	0	4	8	8	8	2	0	0	0

Note: Queue reported is the number of cars per lane.

Hamptons Apartment Complex TIA
 SJ15-1612
 Background AM

Level Of Service Computation Report
 2000 HCM Operations (Future Volume Alternative)
 Background AM

Intersection #15: Tantau Avenue / Stevens Creek Boulevard

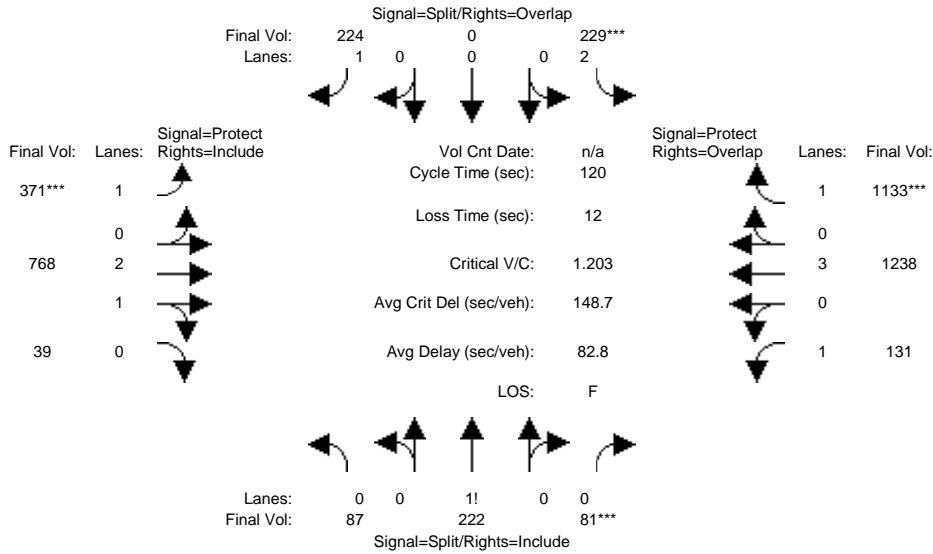

Street Name:	Tantau Avenue						Stevens Creek Boulevard					
	North Bound			South Bound			East Bound			West Bound		
Approach:												
Movement:	L	T	R	L	T	R	L	T	R	L	T	R
Min. Green:	7	10	10	7	10	10	7	10	10	7	10	10
Y+R:	4.0	4.0	4.0	4.0	4.0	4.0	4.0	4.0	4.0	4.0	4.0	4.0

Volume Module:												
Base Vol:	79	175	72	81	0	174	191	565	31	130	770	328
Growth Adj:	1.00	1.00	1.00	1.00	1.00	1.00	1.00	1.00	1.00	1.00	1.00	1.00
Initial Bse:	79	175	72	81	0	174	191	565	31	130	770	328
Added Vol:	0	0	0	0	0	0	0	0	0	0	0	0
PasserByVol:	8	47	9	148	0	50	180	203	8	1	468	805
Initial Fut:	87	222	81	229	0	224	371	768	39	131	1238	1133
User Adj:	1.00	1.00	1.00	1.00	1.00	1.00	1.00	1.00	1.00	1.00	1.00	1.00
PHF Adj:	1.00	1.00	1.00	1.00	1.00	1.00	1.00	1.00	1.00	1.00	1.00	1.00
PHF Volume:	87	222	81	229	0	224	371	768	39	131	1238	1133
Reduct Vol:	0	0	0	0	0	0	0	0	0	0	0	0
Reduced Vol:	87	222	81	229	0	224	371	768	39	131	1238	1133
PCE Adj:	1.00	1.00	1.00	1.00	1.00	1.00	1.00	1.00	1.00	1.00	1.00	1.00
MLF Adj:	1.00	1.00	1.00	1.00	1.00	1.00	1.00	1.00	1.00	1.00	1.00	1.00
Final Volume:	87	222	81	229	0	224	371	768	39	131	1238	1133

Saturation Flow Module:												
Sat/Lane:	1900	1900	1900	1900	1900	1900	1900	1900	1900	1900	1900	1900
Adjustment:	0.92	0.92	0.92	0.83	1.00	0.92	0.92	0.98	0.95	0.92	1.00	0.92
Lanes:	0.22	0.57	0.21	2.00	0.00	1.00	1.00	2.85	0.15	1.00	3.00	1.00
Final Sat.:	390	996	363	3150	0	1750	1750	5329	271	1750	5700	1750

Capacity Analysis Module:												
Vol/Sat:	0.22	0.22	0.22	0.07	0.00	0.13	0.21	0.14	0.14	0.07	0.22	0.65
Crit Moves:			****	****			****					****
Green Time:	22.2	22.2	22.2	7.3	0.0	28.4	21.2	51.7	51.7	26.8	57.4	64.6
Volume/Cap:	1.20	1.20	1.20	1.20	0.00	0.54	1.20	0.33	0.33	0.33	0.45	1.20
Delay/Veh:	165.7	166	165.7	186.7	0.0	41.5	167.3	22.8	22.8	39.6	21.0	129.0
User DelAdj:	1.00	1.00	1.00	1.00	1.00	1.00	1.00	1.00	1.00	1.00	1.00	1.00
AdjDel/Veh:	165.7	166	165.7	186.7	0.0	41.5	167.3	22.8	22.8	39.6	21.0	129.0
LOS by Move:	F	F	F	F	A	D	F	C+	C+	D	C+	F
HCM2kAvgQ:	27	27	27	8	0	8	24	6	6	4	10	72

Note: Queue reported is the number of cars per lane.

Hamptons Apartment Complex TIA
SJ15-1612
Background AM

Level Of Service Computation Report
2000 HCM Operations (Future Volume Alternative)
Background PP AM

Intersection #15: Tantau Avenue / Stevens Creek Boulevard

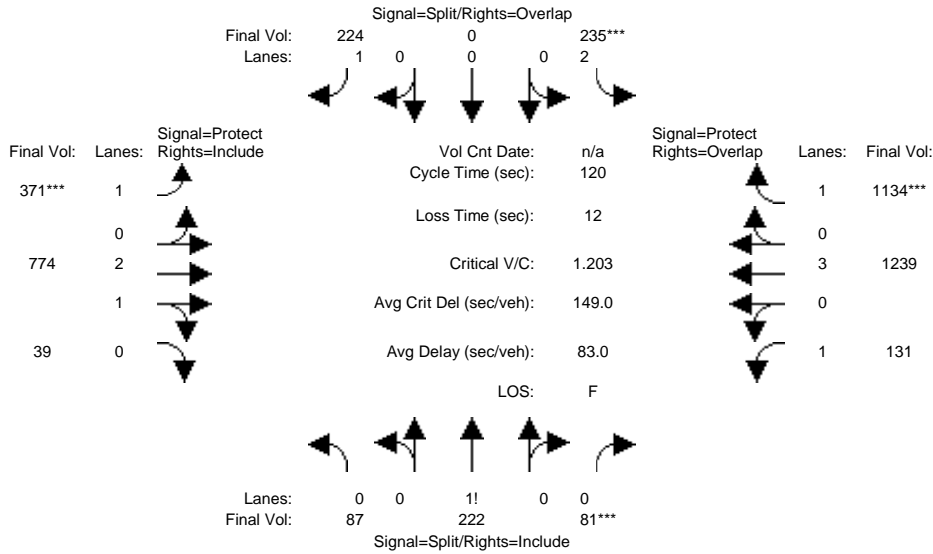

Street Name:	Tantau Avenue						Stevens Creek Boulevard					
	North Bound			South Bound			East Bound			West Bound		
Approach:												
Movement:	L	T	R	L	T	R	L	T	R	L	T	R
Min. Green:	7	10	10	7	10	10	7	10	10	7	10	10
Y+R:	4.0	4.0	4.0	4.0	4.0	4.0	4.0	4.0	4.0	4.0	4.0	4.0

Volume Module:												
Base Vol:	79	175	72	81	0	174	191	565	31	130	770	328
Growth Adj:	1.00	1.00	1.00	1.00	1.00	1.00	1.00	1.00	1.00	1.00	1.00	1.00
Initial Bse:	79	175	72	81	0	174	191	565	31	130	770	328
Added Vol:	0	0	0	6	0	0	0	6	0	0	1	1
PasserByVol:	8	47	9	148	0	50	180	203	8	1	468	805
Initial Fut:	87	222	81	235	0	224	371	774	39	131	1239	1134
User Adj:	1.00	1.00	1.00	1.00	1.00	1.00	1.00	1.00	1.00	1.00	1.00	1.00
PHF Adj:	1.00	1.00	1.00	1.00	1.00	1.00	1.00	1.00	1.00	1.00	1.00	1.00
PHF Volume:	87	222	81	235	0	224	371	774	39	131	1239	1134
Reduct Vol:	0	0	0	0	0	0	0	0	0	0	0	0
Reduced Vol:	87	222	81	235	0	224	371	774	39	131	1239	1134
PCE Adj:	1.00	1.00	1.00	1.00	1.00	1.00	1.00	1.00	1.00	1.00	1.00	1.00
MLF Adj:	1.00	1.00	1.00	1.00	1.00	1.00	1.00	1.00	1.00	1.00	1.00	1.00
Final Volume:	87	222	81	235	0	224	371	774	39	131	1239	1134

Saturation Flow Module:												
Sat/Lane:	1900	1900	1900	1900	1900	1900	1900	1900	1900	1900	1900	1900
Adjustment:	0.92	0.92	0.92	0.83	1.00	0.92	0.92	0.98	0.95	0.92	1.00	0.92
Lanes:	0.22	0.57	0.21	2.00	0.00	1.00	1.00	2.85	0.15	1.00	3.00	1.00
Final Sat.:	390	996	363	3150	0	1750	1750	5331	269	1750	5700	1750

Capacity Analysis Module:												
Vol/Sat:	0.22	0.22	0.22	0.07	0.00	0.13	0.21	0.15	0.15	0.07	0.22	0.65
Crit Moves:			****	****			****					****
Green Time:	22.2	22.2	22.2	7.4	0.0	28.6	21.1	51.7	51.7	26.6	57.2	64.6
Volume/Cap:	1.20	1.20	1.20	1.20	0.00	0.54	1.20	0.34	0.34	0.34	0.46	1.20
Delay/Veh:	166.0	166	166.0	186.1	0.0	41.3	167.6	22.8	22.8	39.8	21.1	129.3
User DelAdj:	1.00	1.00	1.00	1.00	1.00	1.00	1.00	1.00	1.00	1.00	1.00	1.00
AdjDel/Veh:	166.0	166	166.0	186.1	0.0	41.3	167.6	22.8	22.8	39.8	21.1	129.3
LOS by Move:	F	F	F	F	A	D	F	C+	C+	D	C+	F
HCM2kAvgQ:	27	27	27	9	0	8	24	6	6	4	10	72

Note: Queue reported is the number of cars per lane.

Hamptons Apartment Complex TIA
 SJ15-1612
 Background AM

Level Of Service Computation Report
 2000 HCM Operations (Future Volume Alternative)
 Background AM

Intersection #16: Lawrence Expressway / Homestead Road

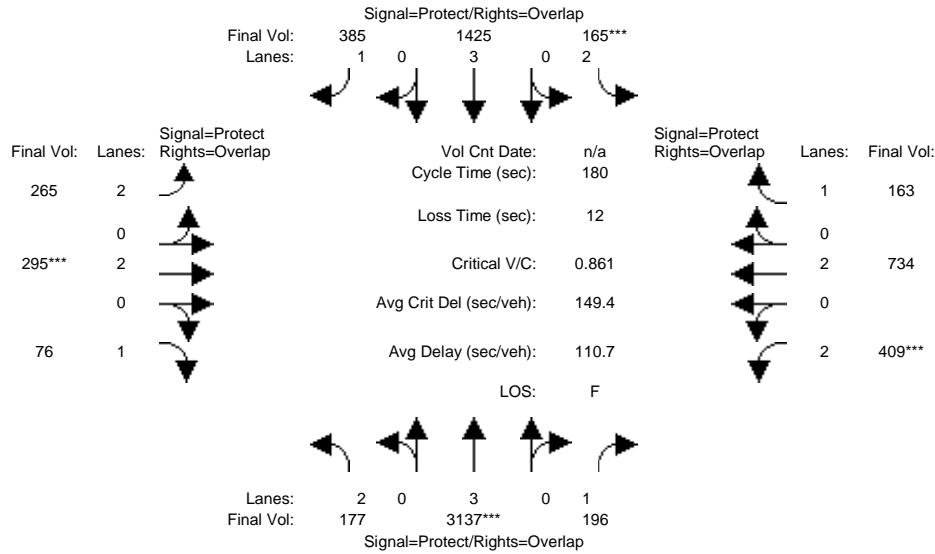

Street Name:	Lawrence Expressway						Homestead Road					
	North Bound			South Bound			East Bound			West Bound		
Approach:	L	T	R	L	T	R	L	T	R	L	T	R
Min. Green:	17	95	95	27	105	105	27	38	38	30	41	41
Y+R:	4.0	4.0	4.0	4.0	4.0	4.0	4.0	4.0	4.0	4.0	4.0	4.0

Volume Module:												
Base Vol:	171	3363	181	135	1369	318	236	271	69	339	625	107
Growth Adj:	1.00	1.00	1.00	1.00	1.00	1.00	1.00	1.00	1.00	1.00	1.00	1.00
Initial Bse:	171	3363	181	135	1369	318	236	271	69	339	625	107
Added Vol:	0	0	0	0	0	0	0	0	0	0	0	0
PasserByVol:	6	328	15	30	307	67	29	24	7	70	109	56
Initial Fut:	177	3691	196	165	1676	385	265	295	76	409	734	163
User Adj:	1.00	0.85	1.00	1.00	0.85	1.00	1.00	1.00	1.00	1.00	1.00	1.00
PHF Adj:	1.00	1.00	1.00	1.00	1.00	1.00	1.00	1.00	1.00	1.00	1.00	1.00
PHF Volume:	177	3137	196	165	1425	385	265	295	76	409	734	163
Reduct Vol:	0	0	0	0	0	0	0	0	0	0	0	0
Reduced Vol:	177	3137	196	165	1425	385	265	295	76	409	734	163
PCE Adj:	1.00	1.00	1.00	1.00	1.00	1.00	1.00	1.00	1.00	1.00	1.00	1.00
MLF Adj:	1.00	1.00	1.00	1.00	1.00	1.00	1.00	1.00	1.00	1.00	1.00	1.00
Final Volume:	177	3137	196	165	1425	385	265	295	76	409	734	163

Saturation Flow Module:												
Sat/Lane:	1900	1900	1900	1900	1900	1900	1900	1900	1900	1900	1900	1900
Adjustment:	0.83	1.00	0.92	0.83	1.00	0.92	0.83	1.00	0.92	0.83	1.00	0.92
Lanes:	2.00	3.00	1.00	2.00	3.00	1.00	2.00	2.00	1.00	2.00	2.00	1.00
Final Sat.:	3150	5700	1750	3150	5700	1750	3150	3800	1750	3150	3800	1750

Capacity Analysis Module:												
Vol/Sat:	0.06	0.55	0.11	0.05	0.25	0.22	0.08	0.08	0.04	0.13	0.19	0.09
Crit Moves:	****			****			****			****		
Green Time:	15.1	84.7	111.4	24.1	93.6	117.6	24.1	33.9	49.0	26.7	36.5	60.6
Volume/Cap:	0.67	1.17	0.18	0.39	0.48	0.34	0.63	0.41	0.16	0.87	0.95	0.28
Delay/Veh:	101.6	166	34.5	88.8	53.6	35.3	85.8	72.6	56.1	100.7	101	49.3
User DelAdj:	1.00	1.00	1.00	1.00	1.00	1.00	1.00	1.00	1.00	1.00	1.00	1.00
AdjDel/Veh:	101.6	166	34.5	88.8	53.6	35.3	85.8	72.6	56.1	100.7	101	49.3
LOS by Move:	F	F	C-	F	D-	D+	F	E	E+	F	F	D
HCM2kAvgQ:	8	83	10	6	25	20	9	7	4	17	26	8

Note: Queue reported is the number of cars per lane.

Hamptons Apartment Complex TIA
SJ15-1612
Background AM

Level Of Service Computation Report
2000 HCM Operations (Future Volume Alternative)
Background PP AM

Intersection #16: Lawrence Expressway / Homestead Road

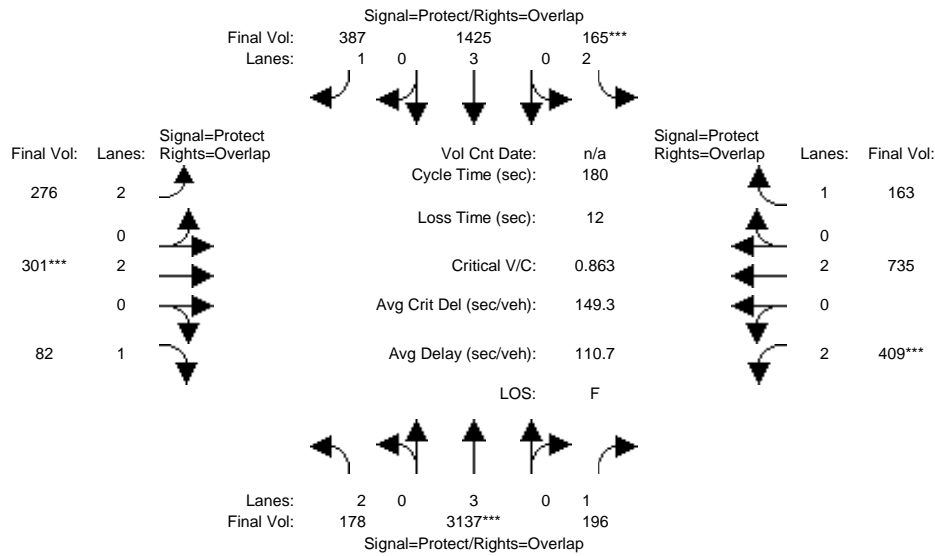

Street Name:	Lawrence Expressway						Homestead Road					
	North Bound			South Bound			East Bound			West Bound		
Approach:	L	T	R	L	T	R	L	T	R	L	T	R
Min. Green:	17	95	95	27	105	105	27	38	38	30	41	41
Y+R:	4.0	4.0	4.0	4.0	4.0	4.0	4.0	4.0	4.0	4.0	4.0	4.0

Volume Module:												
Base Vol:	171	3363	181	135	1369	318	236	271	69	339	625	107
Growth Adj:	1.00	1.00	1.00	1.00	1.00	1.00	1.00	1.00	1.00	1.00	1.00	1.00
Initial Bse:	171	3363	181	135	1369	318	236	271	69	339	625	107
Added Vol:	1	0	0	0	0	2	11	6	6	0	1	0
PasserByVol:	6	328	15	30	307	67	29	24	7	70	109	56
Initial Fut:	178	3691	196	165	1676	387	276	301	82	409	735	163
User Adj:	1.00	0.85	1.00	1.00	0.85	1.00	1.00	1.00	1.00	1.00	1.00	1.00
PHF Adj:	1.00	1.00	1.00	1.00	1.00	1.00	1.00	1.00	1.00	1.00	1.00	1.00
PHF Volume:	178	3137	196	165	1425	387	276	301	82	409	735	163
Reduct Vol:	0	0	0	0	0	0	0	0	0	0	0	0
Reduced Vol:	178	3137	196	165	1425	387	276	301	82	409	735	163
PCE Adj:	1.00	1.00	1.00	1.00	1.00	1.00	1.00	1.00	1.00	1.00	1.00	1.00
MLF Adj:	1.00	1.00	1.00	1.00	1.00	1.00	1.00	1.00	1.00	1.00	1.00	1.00
Final Volume:	178	3137	196	165	1425	387	276	301	82	409	735	163

Saturation Flow Module:												
Sat/Lane:	1900	1900	1900	1900	1900	1900	1900	1900	1900	1900	1900	1900
Adjustment:	0.83	1.00	0.92	0.83	1.00	0.92	0.83	1.00	0.92	0.83	1.00	0.92
Lanes:	2.00	3.00	1.00	2.00	3.00	1.00	2.00	2.00	1.00	2.00	2.00	1.00
Final Sat.:	3150	5700	1750	3150	5700	1750	3150	3800	1750	3150	3800	1750

Capacity Analysis Module:												
Vol/Sat:	0.06	0.55	0.11	0.05	0.25	0.22	0.09	0.08	0.05	0.13	0.19	0.09
Crit Moves:	****			****			****			****		
Green Time:	15.1	84.7	111.4	24.1	93.6	117.6	24.1	33.9	49.0	26.7	36.5	60.6
Volume/Cap:	0.67	1.17	0.18	0.39	0.48	0.34	0.66	0.42	0.17	0.87	0.95	0.28
Delay/Veh:	101.9	166	34.5	88.8	53.6	35.3	86.8	72.7	56.3	100.7	101	49.3
User DelAdj:	1.00	1.00	1.00	1.00	1.00	1.00	1.00	1.00	1.00	1.00	1.00	1.00
AdjDel/Veh:	101.9	166	34.5	88.8	53.6	35.3	86.8	72.7	56.3	100.7	101	49.3
LOS by Move:	F	F	C-	F	D-	D+	F	E	E+	F	F	D
HCM2kAvgQ:	8	83	10	6	25	20	9	8	4	17	26	8

Note: Queue reported is the number of cars per lane.

Hamptons Apartment Complex TIA
 SJ15-1612
 Background PM / Background PP PM

Summary Scenario Comparison Report (With Average Critical Delay)
 Future Volume Alternative

Intersection	???				Background PM				Background PP PM					???				
	LOS	Avg Del (sec)	Crit V/C	Avg Crit Del (sec)	LOS	Avg Del (sec)	Crit V/C	Avg Crit Del (sec)	LOS	Avg Del (sec)	Crit V/C	Crit V/C Change	Avg Crit Del (sec)	Avg Crit Del Change	LOS	Avg Del (sec)	Crit V/C	Avg Crit Del (sec)
#1 Wolfe Road / El Camino Real	?	xx.x	x.xxx	xx.x	D	40.0	0.758	44.2	D	40.1	0.763	+ 0.006	44.5	+ 0.3	?	xx.x	x.xxx	xx.x
#2 Wolfe Road / Fremont Avenue	?	xx.x	x.xxx	xx.x	D+	38.5	0.793	36.8	D+	38.9	0.801	+ 0.008	37.1	+ 0.3	?	xx.x	x.xxx	xx.x
#3 Wolfe Road / Marion Way	?	xx.x	x.xxx	xx.x	C+	20.7	0.622	31.0	C+	20.7	0.629	+ 0.007	30.9	- 0.1	?	xx.x	x.xxx	xx.x
#4 Wolfe Road / Inverness Avenue	?	xx.x	x.xxx	xx.x	C	24.5	0.631	25.3	C	24.3	0.643	+ 0.012	25.2	- 0.1	?	xx.x	x.xxx	xx.x
#5 Wolfe Road / Homestead Road	?	xx.x	x.xxx	xx.x	C	31.3	0.738	36.3	C	31.6	0.751	+ 0.013	36.5	+ 0.2	?	xx.x	x.xxx	xx.x
#6 Wolfe Road / Apple Campus 2	?	xx.x	x.xxx	xx.x	C	28.2	0.761	29.3	C	28.5	0.780	+ 0.018	29.8	+ 0.5	?	xx.x	x.xxx	xx.x
#7 Wolfe Road / Pruneridge Avenue	?	xx.x	x.xxx	xx.x	C	25.3	0.886	30.7	C	29.9	0.948	+ 0.063	36.6	+ 5.9	?	xx.x	x.xxx	xx.x
#8 Wolfe Road / I-280 NB Ramps	?	xx.x	x.xxx	xx.x	C	29.7	0.941	35.4	C-	33.7	0.977	+ 0.036	42.5	+ 7.1	?	xx.x	x.xxx	xx.x
#9 Wolfe Road / I-280 SB Ramps	?	xx.x	x.xxx	xx.x	B	17.0	0.714	19.9	B	17.5	0.729	+ 0.015	20.0	+ 0.1	?	xx.x	x.xxx	xx.x
#10 Wolfe Road / Vallco Parkway	?	xx.x	x.xxx	xx.x	C	29.2	0.668	32.7	C	29.3	0.680	+ 0.012	33.0	+ 0.3	?	xx.x	x.xxx	xx.x
#11 Wolfe Road / Stevens Creek Boulevard	?	xx.x	x.xxx	xx.x	D-	51.4	0.919	58.7	D-	52.8	0.935	+ 0.016	61.3	+ 2.6	?	xx.x	x.xxx	xx.x
#12 De Anza Boulevard / Stevens Creek Boulevard	?	xx.x	x.xxx	xx.x	D-	54.1	0.984	62.3	D-	54.2	0.984	+ 0.000	62.3	+ 0.0	?	xx.x	x.xxx	xx.x
#13 Tantau Avenue / Homestead Road	?	xx.x	x.xxx	xx.x	E-	75.6	1.127	111.4	E-	76.4	1.131	+ 0.005	113.1	+ 1.7	?	xx.x	x.xxx	xx.x
#14 Tantau Avenue / Vallco Parkway	?	xx.x	x.xxx	xx.x	C	29.7	0.745	37.1	C	30.1	0.752	+ 0.007	37.9	+ 0.8	?	xx.x	x.xxx	xx.x
#15 Tantau Avenue / Stevens Creek Boulevard	?	xx.x	x.xxx	xx.x	E+	58.3	0.999	70.5	E+	58.7	1.001	+ 0.002	71.0	+ 0.6	?	xx.x	x.xxx	xx.x
#16 Lawrence Expressway / Homestead Road	?	xx.x	x.xxx	xx.x	F	83.4	0.775	90.9	F	86.1	0.742	- 0.033	92.5	+ 1.6	?	xx.x	x.xxx	xx.x

Hamptons Apartment Complex TIA
 SJ15-1612
 Background PM

Level Of Service Computation Report
 2000 HCM Operations (Future Volume Alternative)
 Background PM

Intersection #0:

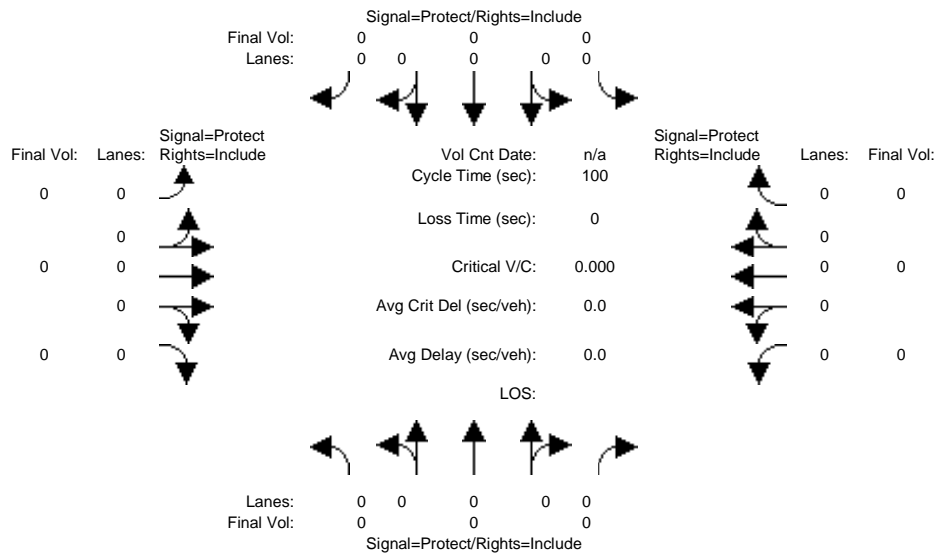

Approach:	North Bound			South Bound			East Bound			West Bound		
	L	T	R	L	T	R	L	T	R	L	T	R
Min. Green:	7	10	10	7	10	10	7	10	10	7	10	10
Y+R:	4.0	4.0	4.0	4.0	4.0	4.0	4.0	4.0	4.0	4.0	4.0	4.0

Volume Module:												
Base Vol:	0	0	0	0	0	0	0	0	0	0	0	0
Growth Adj:	0.00	0.00	0.00	0.00	0.00	0.00	0.00	0.00	0.00	0.00	0.00	0.00
Initial Bse:	0	0	0	0	0	0	0	0	0	0	0	0
Added Vol:	0	0	0	0	0	0	0	0	0	0	0	0
PasserByVol:	0	0	0	0	0	0	0	0	0	0	0	0
Initial Fut:	0	0	0	0	0	0	0	0	0	0	0	0
User Adj:	0.00	0.00	0.00	0.00	0.00	0.00	0.00	0.00	0.00	0.00	0.00	0.00
PHF Adj:	0.00	0.00	0.00	0.00	0.00	0.00	0.00	0.00	0.00	0.00	0.00	0.00
PHF Volume:	0	0	0	0	0	0	0	0	0	0	0	0
Reduct Vol:	0	0	0	0	0	0	0	0	0	0	0	0
Reduced Vol:	0	0	0	0	0	0	0	0	0	0	0	0
PCE Adj:	0.00	0.00	0.00	0.00	0.00	0.00	0.00	0.00	0.00	0.00	0.00	0.00
MLF Adj:	0.00	0.00	0.00	0.00	0.00	0.00	0.00	0.00	0.00	0.00	0.00	0.00
Final Volume:	0	0	0	0	0	0	0	0	0	0	0	0

Saturation Flow Module:												
Sat/Lane:	0	0	0	0	0	0	0	0	0	0	0	0
Adjustment:	1.00	1.00	1.00	1.00	1.00	1.00	1.00	1.00	1.00	1.00	1.00	1.00
Lanes:	0.00	0.00	0.00	0.00	0.00	0.00	0.00	0.00	0.00	0.00	0.00	0.00
Final Sat.:	0	0	0	0	0	0	0	0	0	0	0	0

Capacity Analysis Module:												
Vol/Sat:	0.00	0.00	0.00	0.00	0.00	0.00	0.00	0.00	0.00	0.00	0.00	0.00
Crit Moves:												
Green Time:	0.0	0.0	0.0	0.0	0.0	0.0	0.0	0.0	0.0	0.0	0.0	0.0
Volume/Cap:	0.00	0.00	0.00	0.00	0.00	0.00	0.00	0.00	0.00	0.00	0.00	0.00
Delay/Veh:	0.0	0.0	0.0	0.0	0.0	0.0	0.0	0.0	0.0	0.0	0.0	0.0
User DelAdj:	1.00	1.00	1.00	1.00	1.00	1.00	1.00	1.00	1.00	1.00	1.00	1.00
AdjDel/Veh:	0.0	0.0	0.0	0.0	0.0	0.0	0.0	0.0	0.0	0.0	0.0	0.0
LOS by Move:												
HCM2kAvgQ:	0	0	0	0	0	0	0	0	0	0	0	0

Note: Queue reported is the number of cars per lane.

Hamptons Apartment Complex TIA
 SJ15-1612
 Background PM

Level Of Service Computation Report
 2000 HCM Operations (Future Volume Alternative)
 Background PP PM

Intersection #0:

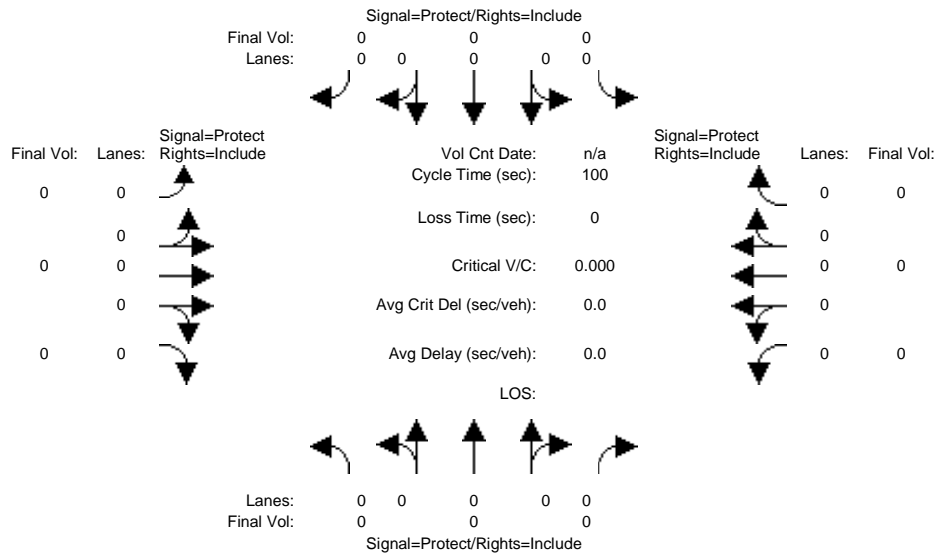

Approach:	North Bound			South Bound			East Bound			West Bound		
	L	T	R	L	T	R	L	T	R	L	T	R
Min. Green:	7	10	10	7	10	10	7	10	10	7	10	10
Y+R:	4.0	4.0	4.0	4.0	4.0	4.0	4.0	4.0	4.0	4.0	4.0	4.0
Volume Module:												
Base Vol:	0	0	0	0	0	0	0	0	0	0	0	0
Growth Adj:	0.00	0.00	0.00	0.00	0.00	0.00	0.00	0.00	0.00	0.00	0.00	0.00
Initial Bse:	0	0	0	0	0	0	0	0	0	0	0	0
Added Vol:	0	0	0	0	0	0	0	0	0	0	0	0
PasserByVol:	0	0	0	0	0	0	0	0	0	0	0	0
Initial Fut:	0	0	0	0	0	0	0	0	0	0	0	0
User Adj:	0.00	0.00	0.00	0.00	0.00	0.00	0.00	0.00	0.00	0.00	0.00	0.00
PHF Adj:	0.00	0.00	0.00	0.00	0.00	0.00	0.00	0.00	0.00	0.00	0.00	0.00
PHF Volume:	0	0	0	0	0	0	0	0	0	0	0	0
Reduct Vol:	0	0	0	0	0	0	0	0	0	0	0	0
Reduced Vol:	0	0	0	0	0	0	0	0	0	0	0	0
PCE Adj:	0.00	0.00	0.00	0.00	0.00	0.00	0.00	0.00	0.00	0.00	0.00	0.00
MLF Adj:	0.00	0.00	0.00	0.00	0.00	0.00	0.00	0.00	0.00	0.00	0.00	0.00
FinalVolume:	0	0	0	0	0	0	0	0	0	0	0	0
Saturation Flow Module:												
Sat/Lane:	0	0	0	0	0	0	0	0	0	0	0	0
Adjustment:	1.00	1.00	1.00	1.00	1.00	1.00	1.00	1.00	1.00	1.00	1.00	1.00
Lanes:	0.00	0.00	0.00	0.00	0.00	0.00	0.00	0.00	0.00	0.00	0.00	0.00
Final Sat.:	0	0	0	0	0	0	0	0	0	0	0	0
Capacity Analysis Module:												
Vol/Sat:	0.00	0.00	0.00	0.00	0.00	0.00	0.00	0.00	0.00	0.00	0.00	0.00
Crit Moves:												
Green Time:	0.0	0.0	0.0	0.0	0.0	0.0	0.0	0.0	0.0	0.0	0.0	0.0
Volume/Cap:	0.00	0.00	0.00	0.00	0.00	0.00	0.00	0.00	0.00	0.00	0.00	0.00
Delay/Veh:	0.0	0.0	0.0	0.0	0.0	0.0	0.0	0.0	0.0	0.0	0.0	0.0
User DelAdj:	1.00	1.00	1.00	1.00	1.00	1.00	1.00	1.00	1.00	1.00	1.00	1.00
AdjDel/Veh:	0.0	0.0	0.0	0.0	0.0	0.0	0.0	0.0	0.0	0.0	0.0	0.0
LOS by Move:												
HCM2kAvgQ:	0	0	0	0	0	0	0	0	0	0	0	0

Note: Queue reported is the number of cars per lane.

Hamptons Apartment Complex TIA
 SJ15-1612
 Background PM

Level Of Service Computation Report
 2000 HCM Operations (Future Volume Alternative)
 Background PM

Intersection #1: Wolfe Road / El Camino Real

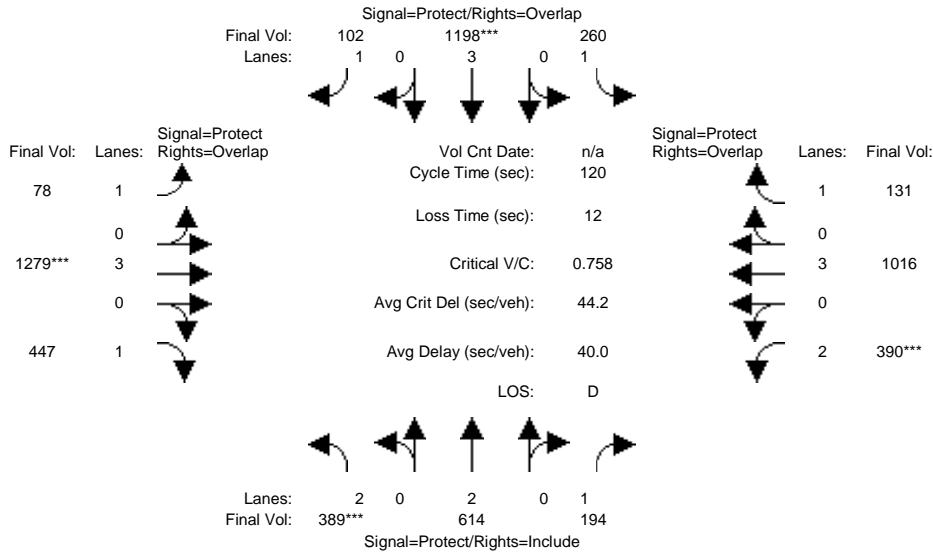

Street Name:	Wolfe Road						El Camino Real					
	North Bound			South Bound			East Bound			West Bound		
Approach:	North Bound			South Bound			East Bound			West Bound		
Movement:	L	T	R	L	T	R	L	T	R	L	T	R
Min. Green:	7	10	10	7	10	10	7	10	10	7	10	10
Y+R:	4.0	4.0	4.0	4.0	4.0	4.0	4.0	4.0	4.0	4.0	4.0	4.0

Volume Module:												
Base Vol:	307	545	170	250	1165	102	78	1239	413	346	834	124
Growth Adj:	1.00	1.00	1.00	1.00	1.00	1.00	1.00	1.00	1.00	1.00	1.00	1.00
Initial Bse:	307	545	170	250	1165	102	78	1239	413	346	834	124
Added Vol:	0	0	0	0	0	0	0	0	0	0	0	0
PasserByVol:	82	69	24	10	33	0	0	40	34	44	182	7
Initial Fut:	389	614	194	260	1198	102	78	1279	447	390	1016	131
User Adj:	1.00	1.00	1.00	1.00	1.00	1.00	1.00	1.00	1.00	1.00	1.00	1.00
PHF Adj:	1.00	1.00	1.00	1.00	1.00	1.00	1.00	1.00	1.00	1.00	1.00	1.00
PHF Volume:	389	614	194	260	1198	102	78	1279	447	390	1016	131
Reduct Vol:	0	0	0	0	0	0	0	0	0	0	0	0
Reduced Vol:	389	614	194	260	1198	102	78	1279	447	390	1016	131
PCE Adj:	1.00	1.00	1.00	1.00	1.00	1.00	1.00	1.00	1.00	1.00	1.00	1.00
MLF Adj:	1.00	1.00	1.00	1.00	1.00	1.00	1.00	1.00	1.00	1.00	1.00	1.00
Final Volume:	389	614	194	260	1198	102	78	1279	447	390	1016	131

Saturation Flow Module:												
Sat/Lane:	1900	1900	1900	1900	1900	1900	1900	1900	1900	1900	1900	1900
Adjustment:	0.83	1.00	0.92	0.92	1.00	0.92	0.92	1.00	0.92	0.83	1.00	0.92
Lanes:	2.00	2.00	1.00	1.00	3.00	1.00	1.00	3.00	1.00	2.00	3.00	1.00
Final Sat.:	3150	3800	1750	1750	5700	1750	1750	5700	1750	3150	5700	1750

Capacity Analysis Module:												
Vol/Sat:	0.12	0.16	0.11	0.15	0.21	0.06	0.04	0.22	0.26	0.12	0.18	0.07
Crit Moves:	***				***			***			***	
Green Time:	19.6	27.5	27.5	25.3	33.3	46.9	13.6	35.5	55.1	19.6	41.6	66.9
Volume/Cap:	0.76	0.70	0.48	0.70	0.76	0.15	0.39	0.76	0.56	0.76	0.51	0.13
Delay/Veh:	54.4	45.1	41.0	49.9	41.8	23.8	50.7	40.4	24.4	54.3	31.4	12.8
User DelAdj:	1.00	1.00	1.00	1.00	1.00	1.00	1.00	1.00	1.00	1.00	1.00	1.00
AdjDel/Veh:	54.4	45.1	41.0	49.9	41.8	23.8	50.7	40.4	24.4	54.3	31.4	12.8
LOS by Move:	D-	D	D	D	D	C	D	D	C	D-	C	B
HCM2kAvgQ:	8	10	6	11	15	3	3	16	13	10	10	2

Note: Queue reported is the number of cars per lane.

Hamptons Apartment Complex TIA
 SJ15-1612
 Background PM

Level Of Service Computation Report
 2000 HCM Operations (Future Volume Alternative)
 Background PP PM

Intersection #1: Wolfe Road / El Camino Real

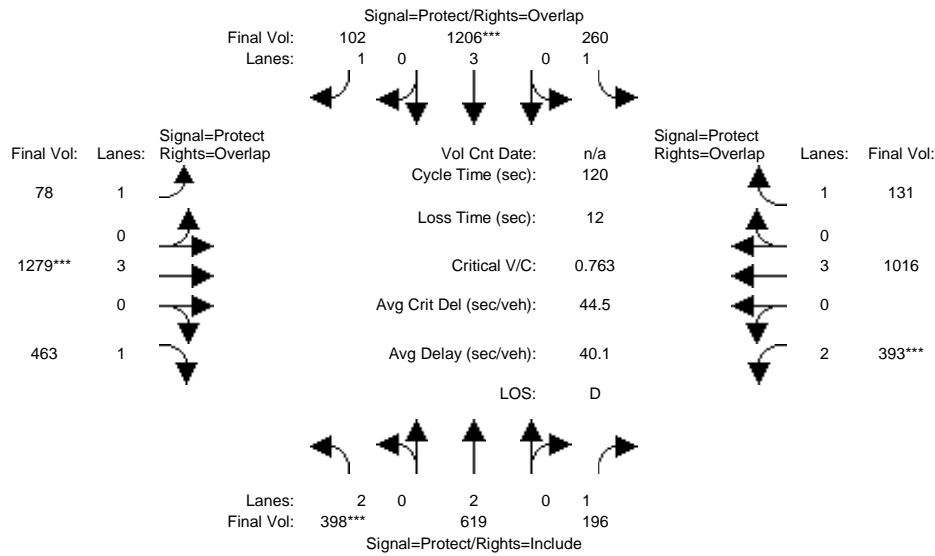

Street Name:	Wolfe Road						El Camino Real					
	North Bound			South Bound			East Bound			West Bound		
Approach:	North Bound			South Bound			East Bound			West Bound		
Movement:	L	T	R	L	T	R	L	T	R	L	T	R
Min. Green:	7	10	10	7	10	10	7	10	10	7	10	10
Y+R:	4.0	4.0	4.0	4.0	4.0	4.0	4.0	4.0	4.0	4.0	4.0	4.0

Volume Module:												
Base Vol:	307	545	170	250	1165	102	78	1239	413	346	834	124
Growth Adj:	1.00	1.00	1.00	1.00	1.00	1.00	1.00	1.00	1.00	1.00	1.00	1.00
Initial Bse:	307	545	170	250	1165	102	78	1239	413	346	834	124
Added Vol:	9	5	2	0	8	0	0	0	16	3	0	0
PasserByVol:	82	69	24	10	33	0	0	40	34	44	182	7
Initial Fut:	398	619	196	260	1206	102	78	1279	463	393	1016	131
User Adj:	1.00	1.00	1.00	1.00	1.00	1.00	1.00	1.00	1.00	1.00	1.00	1.00
PHF Adj:	1.00	1.00	1.00	1.00	1.00	1.00	1.00	1.00	1.00	1.00	1.00	1.00
PHF Volume:	398	619	196	260	1206	102	78	1279	463	393	1016	131
Reduct Vol:	0	0	0	0	0	0	0	0	0	0	0	0
Reduced Vol:	398	619	196	260	1206	102	78	1279	463	393	1016	131
PCE Adj:	1.00	1.00	1.00	1.00	1.00	1.00	1.00	1.00	1.00	1.00	1.00	1.00
MLF Adj:	1.00	1.00	1.00	1.00	1.00	1.00	1.00	1.00	1.00	1.00	1.00	1.00
Final Volume:	398	619	196	260	1206	102	78	1279	463	393	1016	131

Saturation Flow Module:												
Sat/Lane:	1900	1900	1900	1900	1900	1900	1900	1900	1900	1900	1900	1900
Adjustment:	0.83	1.00	0.92	0.92	1.00	0.92	0.92	1.00	0.92	0.83	1.00	0.92
Lanes:	2.00	2.00	1.00	1.00	3.00	1.00	1.00	3.00	1.00	2.00	3.00	1.00
Final Sat.:	3150	3800	1750	1750	5700	1750	1750	5700	1750	3150	5700	1750

Capacity Analysis Module:												
Vol/Sat:	0.13	0.16	0.11	0.15	0.21	0.06	0.04	0.22	0.26	0.12	0.18	0.07
Crit Moves:	***				***			***			***	
Green Time:	19.9	27.8	27.8	25.3	33.3	46.8	13.5	35.3	55.1	19.6	41.3	66.7
Volume/Cap:	0.76	0.70	0.48	0.70	0.76	0.15	0.40	0.76	0.58	0.76	0.52	0.13
Delay/Veh:	54.4	44.9	40.8	49.9	42.0	23.8	50.7	40.7	24.9	54.7	31.6	12.9
User DelAdj:	1.00	1.00	1.00	1.00	1.00	1.00	1.00	1.00	1.00	1.00	1.00	1.00
AdjDel/Veh:	54.4	44.9	40.8	49.9	42.0	23.8	50.7	40.7	24.9	54.7	31.6	12.9
LOS by Move:	D-	D	D	D	D	C	D	D	C	D-	C	B
HCM2kAvgQ:	8	10	6	11	15	3	3	16	14	10	10	2

Note: Queue reported is the number of cars per lane.

Hamptons Apartment Complex TIA
SJ15-1612
Background PM

Level Of Service Computation Report
2000 HCM Operations (Future Volume Alternative)
Background PM

Intersection #2: Wolfe Road / Fremont Avenue

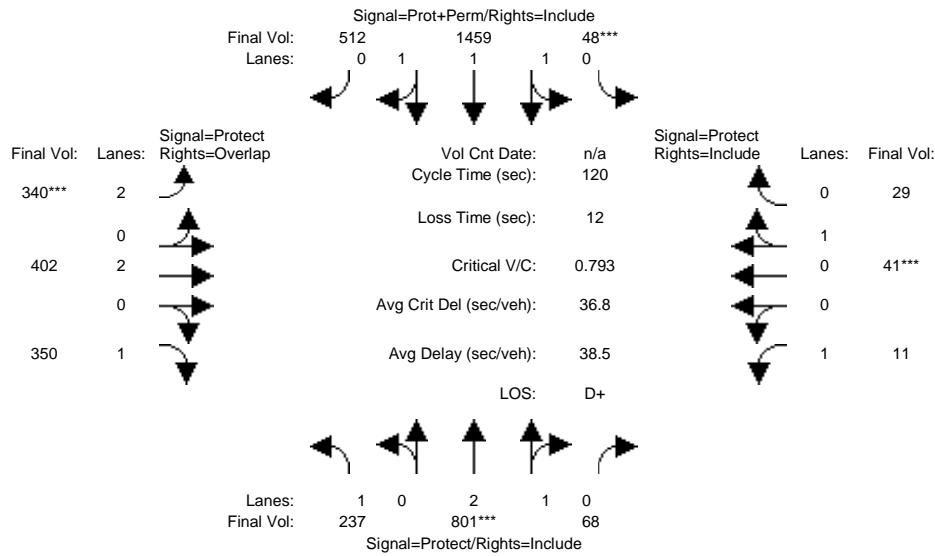

Street Name:	Wolfe Road						Fremont Avenue					
	North Bound			South Bound			East Bound			West Bound		
	L	T	R	L	T	R	L	T	R	L	T	R
Min. Green:	7	10	10	7	10	10	7	10	10	7	10	10
Y+R:	4.0	4.0	4.0	4.0	4.0	4.0	4.0	4.0	4.0	4.0	4.0	4.0

Volume Module:												
Base Vol:	183	632	53	48	1362	512	340	402	322	11	41	29
Growth Adj:	1.00	1.00	1.00	1.00	1.00	1.00	1.00	1.00	1.00	1.00	1.00	1.00
Initial Bse:	183	632	53	48	1362	512	340	402	322	11	41	29
Added Vol:	0	0	0	0	0	0	0	0	0	0	0	0
PasserByVol:	54	169	15	0	97	0	0	0	28	0	0	0
Initial Fut:	237	801	68	48	1459	512	340	402	350	11	41	29
User Adj:	1.00	1.00	1.00	1.00	1.00	1.00	1.00	1.00	1.00	1.00	1.00	1.00
PHF Adj:	1.00	1.00	1.00	1.00	1.00	1.00	1.00	1.00	1.00	1.00	1.00	1.00
PHF Volume:	237	801	68	48	1459	512	340	402	350	11	41	29
Reduct Vol:	0	0	0	0	0	0	0	0	0	0	0	0
Reduced Vol:	237	801	68	48	1459	512	340	402	350	11	41	29
PCE Adj:	1.00	1.00	1.00	1.00	1.00	1.00	1.00	1.00	1.00	1.00	1.00	1.00
MLF Adj:	1.00	1.00	1.00	1.00	1.00	1.00	1.00	1.00	1.00	1.00	1.00	1.00
Final Volume:	237	801	68	48	1459	512	340	402	350	11	41	29

Saturation Flow Module:												
Sat/Lane:	1900	1900	1900	1900	1900	1900	1900	1900	1900	1900	1900	1900
Adjustment:	0.92	0.99	0.95	0.95	0.97	0.95	0.83	1.00	0.92	0.92	0.95	0.95
Lanes:	1.00	2.76	0.24	0.07	2.16	0.77	2.00	2.00	1.00	1.00	0.59	0.41
Final Sat.:	1750	5161	438	131	3974	1395	3150	3800	1750	1750	1054	746

Capacity Analysis Module:												
Vol/Sat:	0.14	0.16	0.16	0.00	0.37	0.37	0.11	0.11	0.20	0.01	0.04	0.04
Crit Moves:	****			****			****			****		
Green Time:	21.9	24.1	24.1	57.1	59.3	59.3	16.8	17.3	39.1	9.5	10.0	10.0
Volume/Cap:	0.74	0.77	0.77	0.77	0.74	0.74	0.77	0.74	0.61	0.08	0.47	0.47
Delay/Veh:	55.4	48.7	48.7	27.5	25.4	25.4	58.0	54.3	36.0	51.4	54.7	54.7
User DelAdj:	1.00	1.00	1.00	1.00	1.00	1.00	1.00	1.00	1.00	1.00	1.00	1.00
AdjDel/Veh:	55.4	48.7	48.7	27.5	25.4	25.4	58.0	54.3	36.0	51.4	54.7	54.7
LOS by Move:	E+	D	D	C	C	C	E+	D-	D+	D-	D-	D-
HCM2kAvgQ:	9	10	10	21	20	20	9	9	12	0	3	3

Note: Queue reported is the number of cars per lane.

Hamptons Apartment Complex TIA
SJ15-1612
Background PM

Level Of Service Computation Report
2000 HCM Operations (Future Volume Alternative)
Background PP PM

Intersection #2: Wolfe Road / Fremont Avenue

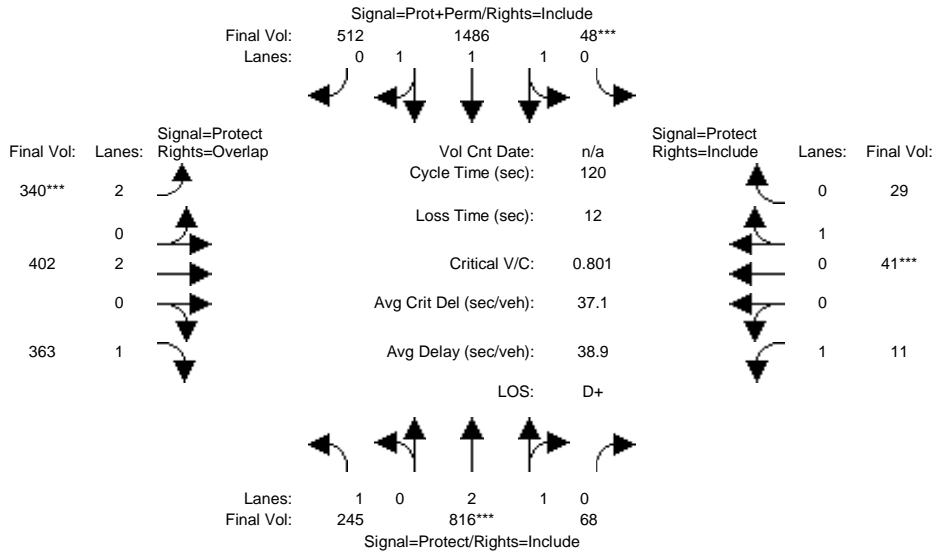

Street Name:	Wolfe Road						Fremont Avenue					
	North Bound			South Bound			East Bound			West Bound		
Approach:	L	T	R	L	T	R	L	T	R	L	T	R
Min. Green:	7	10	10	7	10	10	7	10	10	7	10	10
Y+R:	4.0	4.0	4.0	4.0	4.0	4.0	4.0	4.0	4.0	4.0	4.0	4.0

Volume Module:												
Base Vol:	183	632	53	48	1362	512	340	402	322	11	41	29
Growth Adj:	1.00	1.00	1.00	1.00	1.00	1.00	1.00	1.00	1.00	1.00	1.00	1.00
Initial Bse:	183	632	53	48	1362	512	340	402	322	11	41	29
Added Vol:	8	15	0	0	27	0	0	0	13	0	0	0
PasserByVol:	54	169	15	0	97	0	0	0	28	0	0	0
Initial Fut:	245	816	68	48	1486	512	340	402	363	11	41	29
User Adj:	1.00	1.00	1.00	1.00	1.00	1.00	1.00	1.00	1.00	1.00	1.00	1.00
PHF Adj:	1.00	1.00	1.00	1.00	1.00	1.00	1.00	1.00	1.00	1.00	1.00	1.00
PHF Volume:	245	816	68	48	1486	512	340	402	363	11	41	29
Reduct Vol:	0	0	0	0	0	0	0	0	0	0	0	0
Reduced Vol:	245	816	68	48	1486	512	340	402	363	11	41	29
PCE Adj:	1.00	1.00	1.00	1.00	1.00	1.00	1.00	1.00	1.00	1.00	1.00	1.00
MLF Adj:	1.00	1.00	1.00	1.00	1.00	1.00	1.00	1.00	1.00	1.00	1.00	1.00
Final Volume:	245	816	68	48	1486	512	340	402	363	11	41	29

Saturation Flow Module:												
Sat/Lane:	1900	1900	1900	1900	1900	1900	1900	1900	1900	1900	1900	1900
Adjustment:	0.92	0.99	0.95	0.95	0.97	0.95	0.83	1.00	0.92	0.92	0.95	0.95
Lanes:	1.00	2.76	0.24	0.07	2.17	0.76	2.00	2.00	1.00	1.00	0.59	0.41
Final Sat.:	1750	5169	431	129	3994	1376	3150	3800	1750	1750	1054	746

Capacity Analysis Module:												
Vol/Sat:	0.14	0.16	0.16	0.00	0.37	0.37	0.11	0.11	0.21	0.01	0.04	0.04
Crit Moves:	****			****			****			****		
Green Time:	22.3	24.3	24.3	57.2	59.2	59.2	16.6	17.1	39.4	9.4	10.0	10.0
Volume/Cap:	0.75	0.78	0.78	0.78	0.75	0.75	0.78	0.74	0.63	0.08	0.47	0.47
Delay/Veh:	56.0	48.9	48.9	27.8	25.8	25.8	58.8	54.7	36.4	51.5	54.7	54.7
User DelAdj:	1.00	1.00	1.00	1.00	1.00	1.00	1.00	1.00	1.00	1.00	1.00	1.00
AdjDel/Veh:	56.0	48.9	48.9	27.8	25.8	25.8	58.8	54.7	36.4	51.5	54.7	54.7
LOS by Move:	E+	D	D	C	C	C	E+	D-	D+	D-	D-	D-
HCM2kAvgQ:	9	11	11	21	20	20	9	9	13	0	3	3

Note: Queue reported is the number of cars per lane.

Hamptons Apartment Complex TIA
 SJ15-1612
 Background PM

Level Of Service Computation Report
 2000 HCM Operations (Future Volume Alternative)
 Background PM

Intersection #3: Wolfe Road / Marion Way

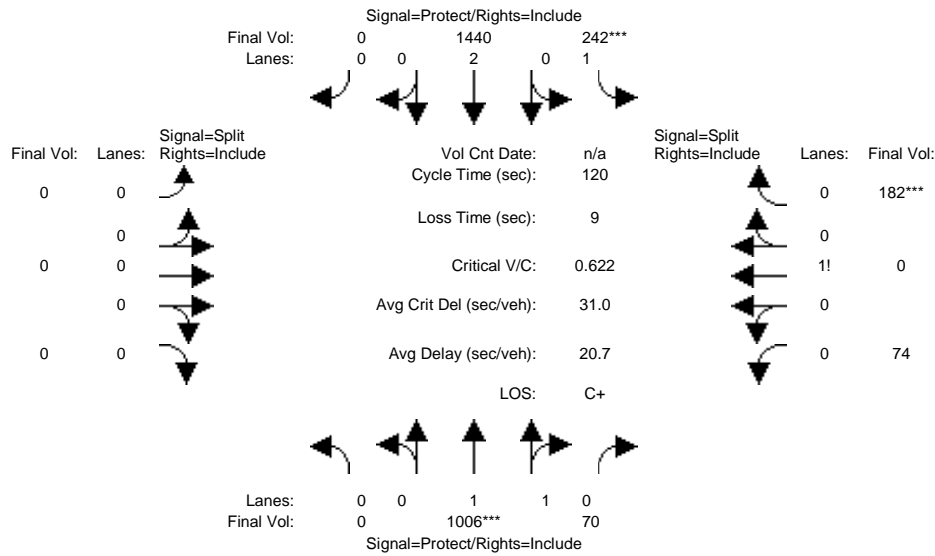

Street Name:	Wolfe Road						Marion Way					
	North Bound			South Bound			East Bound			West Bound		
Approach:	L	T	R	L	T	R	L	T	R	L	T	R
Min. Green:	0	10	10	7	10	0	0	0	0	7	0	10
Y+R:	4.0	4.0	4.0	4.0	4.0	4.0	4.0	4.0	4.0	4.0	4.0	4.0

Volume Module:												
Base Vol:	0	782	70	242	1329	0	0	0	0	74	0	182
Growth Adj:	1.00	1.00	1.00	1.00	1.00	1.00	1.00	1.00	1.00	1.00	1.00	1.00
Initial Bse:	0	782	70	242	1329	0	0	0	0	74	0	182
Added Vol:	0	0	0	0	0	0	0	0	0	0	0	0
PasserByVol:	0	224	0	0	111	0	0	0	0	0	0	0
Initial Fut:	0	1006	70	242	1440	0	0	0	0	74	0	182
User Adj:	1.00	1.00	1.00	1.00	1.00	1.00	1.00	1.00	1.00	1.00	1.00	1.00
PHF Adj:	1.00	1.00	1.00	1.00	1.00	1.00	1.00	1.00	1.00	1.00	1.00	1.00
PHF Volume:	0	1006	70	242	1440	0	0	0	0	74	0	182
Reduct Vol:	0	0	0	0	0	0	0	0	0	0	0	0
Reduced Vol:	0	1006	70	242	1440	0	0	0	0	74	0	182
PCE Adj:	1.00	1.00	1.00	1.00	1.00	1.00	1.00	1.00	1.00	1.00	1.00	1.00
MLF Adj:	1.00	1.00	1.00	1.00	1.00	1.00	1.00	1.00	1.00	1.00	1.00	1.00
Final Volume:	0	1006	70	242	1440	0	0	0	0	74	0	182

Saturation Flow Module:												
Sat/Lane:	1900	1900	1900	1900	1900	1900	1900	1900	1900	1900	1900	1900
Adjustment:	0.92	0.98	0.95	0.92	1.00	0.92	0.92	1.00	0.92	0.92	0.92	0.92
Lanes:	0.00	1.87	0.13	1.00	2.00	0.00	0.00	0.00	0.00	0.29	0.00	0.71
Final Sat.:	0	3459	241	1750	3800	0	0	0	0	506	0	1244

Capacity Analysis Module:												
Vol/Sat:	0.00	0.29	0.29	0.14	0.38	0.00	0.00	0.00	0.00	0.15	0.00	0.15
Crit Moves:	****			****						****		
Green Time:	0.0	56.1	56.1	26.7	82.8	0.0	0.0	0.0	0.0	28.2	0.0	28.2
Volume/Cap:	0.00	0.62	0.62	0.62	0.55	0.00	0.00	0.00	0.00	0.62	0.00	0.62
Delay/Veh:	0.0	24.7	24.7	45.2	9.5	0.0	0.0	0.0	0.0	44.1	0.0	44.1
User DelAdj:	1.00	1.00	1.00	1.00	1.00	1.00	1.00	1.00	1.00	1.00	1.00	1.00
AdjDel/Veh:	0.0	24.7	24.7	45.2	9.5	0.0	0.0	0.0	0.0	44.1	0.0	44.1
LOS by Move:	A	C	C	D	A	A	A	A	A	D	A	D
HCM2kAvgQ:	0	15	15	8	13	0	0	0	0	10	0	10

Note: Queue reported is the number of cars per lane.

Hamptons Apartment Complex TIA
 SJ15-1612
 Background PM

Level Of Service Computation Report
 2000 HCM Operations (Future Volume Alternative)
 Background PP PM

Intersection #3: Wolfe Road / Marion Way

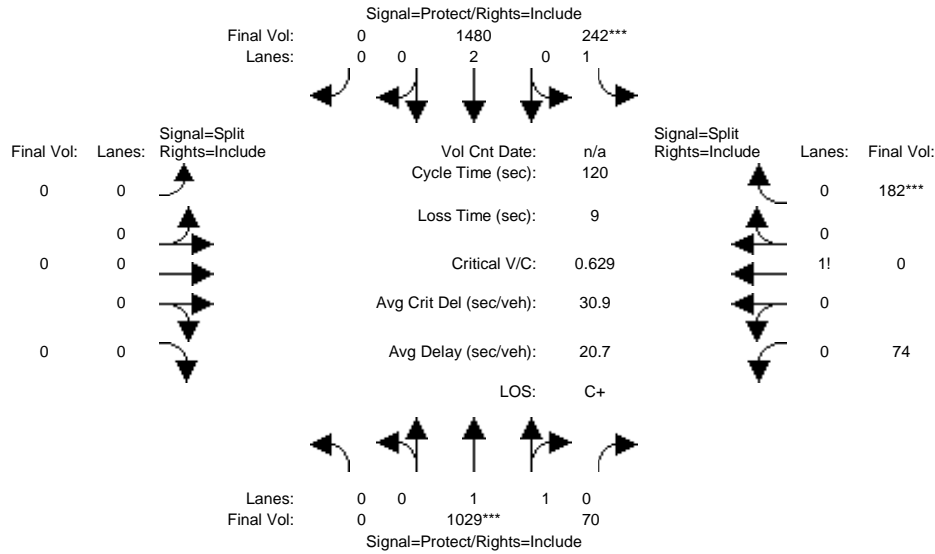

Street Name:	Wolfe Road						Marion Way					
	North Bound			South Bound			East Bound			West Bound		
Approach:	L	T	R	L	T	R	L	T	R	L	T	R
Min. Green:	0	10	10	7	10	0	0	0	0	7	0	10
Y+R:	4.0	4.0	4.0	4.0	4.0	4.0	4.0	4.0	4.0	4.0	4.0	4.0

Volume Module:												
Base Vol:	0	782	70	242	1329	0	0	0	0	74	0	182
Growth Adj:	1.00	1.00	1.00	1.00	1.00	1.00	1.00	1.00	1.00	1.00	1.00	1.00
Initial Bse:	0	782	70	242	1329	0	0	0	0	74	0	182
Added Vol:	0	23	0	0	40	0	0	0	0	0	0	0
PasserByVol:	0	224	0	0	111	0	0	0	0	0	0	0
Initial Fut:	0	1029	70	242	1480	0	0	0	0	74	0	182
User Adj:	1.00	1.00	1.00	1.00	1.00	1.00	1.00	1.00	1.00	1.00	1.00	1.00
PHF Adj:	1.00	1.00	1.00	1.00	1.00	1.00	1.00	1.00	1.00	1.00	1.00	1.00
PHF Volume:	0	1029	70	242	1480	0	0	0	0	74	0	182
Reduct Vol:	0	0	0	0	0	0	0	0	0	0	0	0
Reduced Vol:	0	1029	70	242	1480	0	0	0	0	74	0	182
PCE Adj:	1.00	1.00	1.00	1.00	1.00	1.00	1.00	1.00	1.00	1.00	1.00	1.00
MLF Adj:	1.00	1.00	1.00	1.00	1.00	1.00	1.00	1.00	1.00	1.00	1.00	1.00
Final Volume:	0	1029	70	242	1480	0	0	0	0	74	0	182

Saturation Flow Module:												
Sat/Lane:	1900	1900	1900	1900	1900	1900	1900	1900	1900	1900	1900	1900
Adjustment:	0.92	0.98	0.95	0.92	1.00	0.92	0.92	1.00	0.92	0.92	0.92	0.92
Lanes:	0.00	1.87	0.13	1.00	2.00	0.00	0.00	0.00	0.00	0.29	0.00	0.71
Final Sat.:	0	3464	236	1750	3800	0	0	0	0	506	0	1244

Capacity Analysis Module:												
Vol/Sat:	0.00	0.30	0.30	0.14	0.39	0.00	0.00	0.00	0.00	0.15	0.00	0.15
Crit Moves:	****			****						****		
Green Time:	0.0	56.7	56.7	26.4	83.1	0.0	0.0	0.0	0.0	27.9	0.0	27.9
Volume/Cap:	0.00	0.63	0.63	0.63	0.56	0.00	0.00	0.00	0.00	0.63	0.00	0.63
Delay/Veh:	0.0	24.5	24.5	45.7	9.6	0.0	0.0	0.0	0.0	44.5	0.0	44.5
User DelAdj:	1.00	1.00	1.00	1.00	1.00	1.00	1.00	1.00	1.00	1.00	1.00	1.00
AdjDel/Veh:	0.0	24.5	24.5	45.7	9.6	0.0	0.0	0.0	0.0	44.5	0.0	44.5
LOS by Move:	A	C	C	D	A	A	A	A	A	D	A	D
HCM2kAvgQ:	0	15	15	8	13	0	0	0	0	10	0	10

Note: Queue reported is the number of cars per lane.

Hamptons Apartment Complex TIA
SJ15-1612
Background PM

Level Of Service Computation Report
2000 HCM Operations (Future Volume Alternative)
Background PM

Intersection #4: Wolfe Road / Inverness Avenue

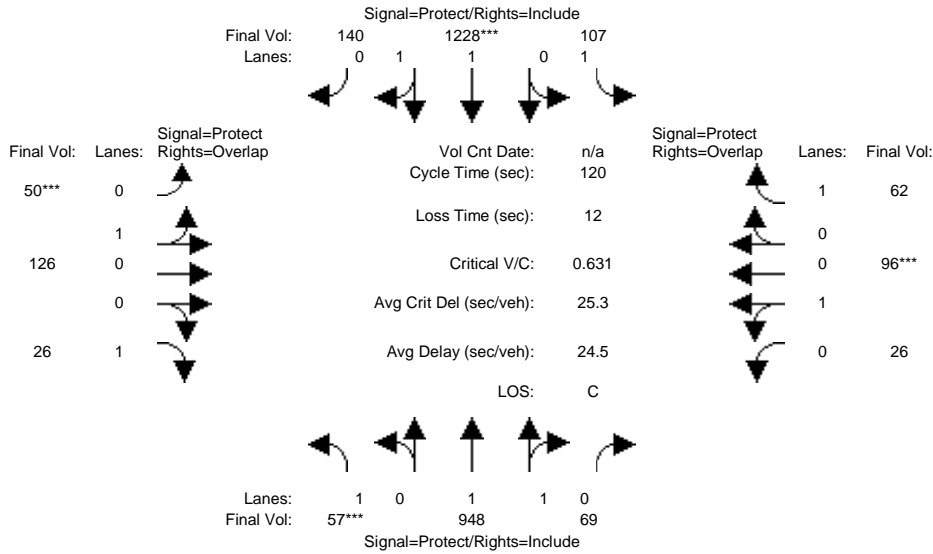

Street Name:	Wolfe Road						Inverness Avenue					
	North Bound			South Bound			East Bound			West Bound		
Approach:	North Bound			South Bound			East Bound			West Bound		
Movement:	L	T	R	L	T	R	L	T	R	L	T	R
Min. Green:	7	10	10	7	10	10	7	10	10	7	10	10
Y+R:	4.0	4.0	4.0	4.0	4.0	4.0	4.0	4.0	4.0	4.0	4.0	4.0

Volume Module:												
Base Vol:	34	724	66	107	1117	140	50	126	20	25	96	62
Growth Adj:	1.00	1.00	1.00	1.00	1.00	1.00	1.00	1.00	1.00	1.00	1.00	1.00
Initial Bse:	34	724	66	107	1117	140	50	126	20	25	96	62
Added Vol:	0	0	0	0	0	0	0	0	0	0	0	0
PasserByVol:	23	224	3	0	111	0	0	0	6	1	0	0
Initial Fut:	57	948	69	107	1228	140	50	126	26	26	96	62
User Adj:	1.00	1.00	1.00	1.00	1.00	1.00	1.00	1.00	1.00	1.00	1.00	1.00
PHF Adj:	1.00	1.00	1.00	1.00	1.00	1.00	1.00	1.00	1.00	1.00	1.00	1.00
PHF Volume:	57	948	69	107	1228	140	50	126	26	26	96	62
Reduct Vol:	0	0	0	0	0	0	0	0	0	0	0	0
Reduced Vol:	57	948	69	107	1228	140	50	126	26	26	96	62
PCE Adj:	1.00	1.00	1.00	1.00	1.00	1.00	1.00	1.00	1.00	1.00	1.00	1.00
MLF Adj:	1.00	1.00	1.00	1.00	1.00	1.00	1.00	1.00	1.00	1.00	1.00	1.00
Final Volume:	57	948	69	107	1228	140	50	126	26	26	96	62

Saturation Flow Module:												
Sat/Lane:	1900	1900	1900	1900	1900	1900	1900	1900	1900	1900	1900	1900
Adjustment:	0.92	0.98	0.95	0.92	0.98	0.95	0.95	0.95	0.92	0.95	0.95	0.92
Lanes:	1.00	1.86	0.14	1.00	1.79	0.21	0.28	0.72	1.00	0.21	0.79	1.00
Final Sat.:	1750	3449	251	1750	3321	379	511	1289	1750	384	1416	1750

Capacity Analysis Module:												
Vol/Sat:	0.03	0.27	0.27	0.06	0.37	0.37	0.10	0.10	0.01	0.07	0.07	0.04
Crit Moves:	***			***			***			***		
Green Time:	7.0	62.8	62.8	14.0	69.8	69.8	18.4	18.4	25.4	12.8	12.8	26.8
Volume/Cap:	0.56	0.53	0.53	0.53	0.64	0.64	0.64	0.64	0.07	0.64	0.64	0.16
Delay/Veh:	61.8	19.1	19.1	52.4	17.3	17.3	52.5	52.5	37.9	58.3	58.3	37.7
User DelAdj:	1.00	1.00	1.00	1.00	1.00	1.00	1.00	1.00	1.00	1.00	1.00	1.00
AdjDel/Veh:	61.8	19.1	19.1	52.4	17.3	17.3	52.5	52.5	37.9	58.3	58.3	37.7
LOS by Move:	E	B-	B-	D-	B	B	D-	D-	D+	E+	E+	D+
HCM2kAvgQ:	2	12	12	4	17	17	7	7	1	6	6	2

Note: Queue reported is the number of cars per lane.

Hamptons Apartment Complex TIA
 SJ15-1612
 Background PM

Level Of Service Computation Report
 2000 HCM Operations (Future Volume Alternative)
 Background PP PM

Intersection #4: Wolfe Road / Inverness Avenue

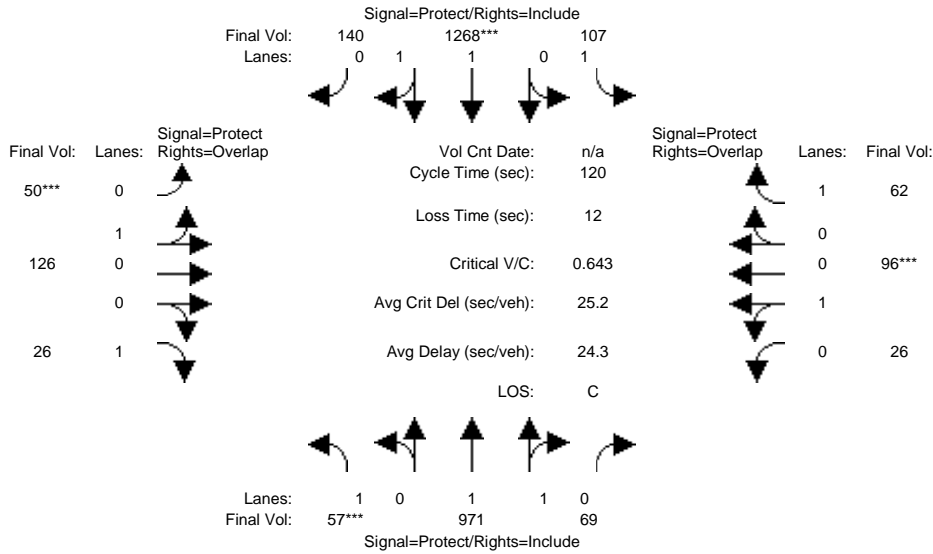

Street Name:	Wolfe Road						Inverness Avenue					
	North Bound			South Bound			East Bound			West Bound		
Approach:	North Bound			South Bound			East Bound			West Bound		
Movement:	L	T	R	L	T	R	L	T	R	L	T	R
Min. Green:	7	10	10	7	10	10	7	10	10	7	10	10
Y+R:	4.0	4.0	4.0	4.0	4.0	4.0	4.0	4.0	4.0	4.0	4.0	4.0

Volume Module:												
Base Vol:	34	724	66	107	1117	140	50	126	20	25	96	62
Growth Adj:	1.00	1.00	1.00	1.00	1.00	1.00	1.00	1.00	1.00	1.00	1.00	1.00
Initial Bse:	34	724	66	107	1117	140	50	126	20	25	96	62
Added Vol:	0	23	0	0	40	0	0	0	0	0	0	0
PasserByVol:	23	224	3	0	111	0	0	0	6	1	0	0
Initial Fut:	57	971	69	107	1268	140	50	126	26	26	96	62
User Adj:	1.00	1.00	1.00	1.00	1.00	1.00	1.00	1.00	1.00	1.00	1.00	1.00
PHF Adj:	1.00	1.00	1.00	1.00	1.00	1.00	1.00	1.00	1.00	1.00	1.00	1.00
PHF Volume:	57	971	69	107	1268	140	50	126	26	26	96	62
Reduct Vol:	0	0	0	0	0	0	0	0	0	0	0	0
Reduced Vol:	57	971	69	107	1268	140	50	126	26	26	96	62
PCE Adj:	1.00	1.00	1.00	1.00	1.00	1.00	1.00	1.00	1.00	1.00	1.00	1.00
MLF Adj:	1.00	1.00	1.00	1.00	1.00	1.00	1.00	1.00	1.00	1.00	1.00	1.00
Final Volume:	57	971	69	107	1268	140	50	126	26	26	96	62

Saturation Flow Module:												
Sat/Lane:	1900	1900	1900	1900	1900	1900	1900	1900	1900	1900	1900	1900
Adjustment:	0.92	0.98	0.95	0.92	0.98	0.95	0.95	0.95	0.92	0.95	0.95	0.92
Lanes:	1.00	1.86	0.14	1.00	1.80	0.20	0.28	0.72	1.00	0.21	0.79	1.00
Final Sat.:	1750	3454	245	1750	3332	368	511	1289	1750	384	1416	1750

Capacity Analysis Module:												
Vol/Sat:	0.03	0.28	0.28	0.06	0.38	0.38	0.10	0.10	0.01	0.07	0.07	0.04
Crit Moves:	***			***			***			***		
Green Time:	7.0	63.6	63.6	13.8	70.4	70.4	18.1	18.1	25.1	12.5	12.5	26.4
Volume/Cap:	0.56	0.53	0.53	0.53	0.65	0.65	0.65	0.65	0.07	0.65	0.65	0.16
Delay/Veh:	61.8	18.7	18.7	52.7	17.3	17.3	53.4	53.4	38.2	59.3	59.3	38.1
User DelAdj:	1.00	1.00	1.00	1.00	1.00	1.00	1.00	1.00	1.00	1.00	1.00	1.00
AdjDel/Veh:	61.8	18.7	18.7	52.7	17.3	17.3	53.4	53.4	38.2	59.3	59.3	38.1
LOS by Move:	E	B-	B-	D-	B	B	D-	D-	D+	E+	E+	D+
HCM2kAvgQ:	2	12	12	4	17	17	7	7	1	6	6	2

Note: Queue reported is the number of cars per lane.

Hamptons Apartment Complex TIA
 SJ15-1612
 Background PM

Level Of Service Computation Report
 2000 HCM Operations (Future Volume Alternative)
 Background PM

Intersection #5: Wolfe Road / Homestead Road

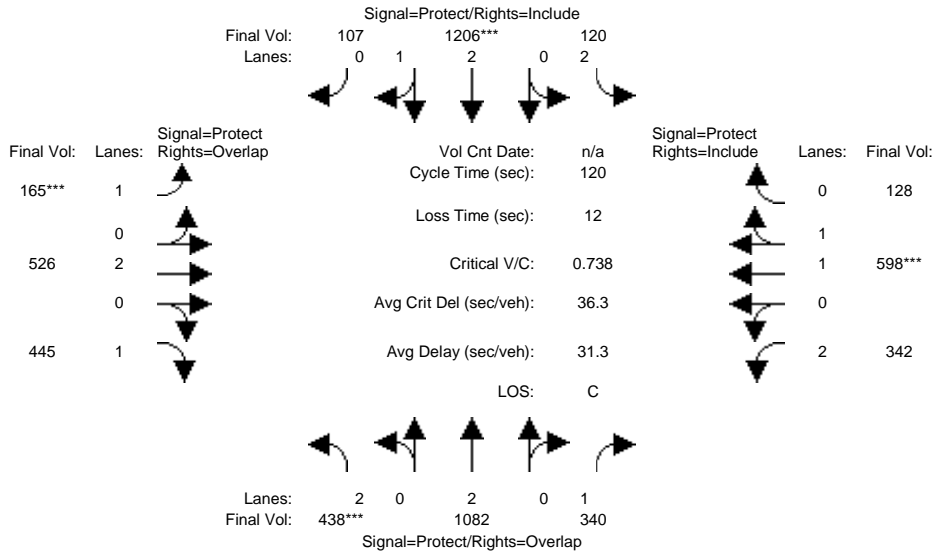

Street Name:	Wolfe Road						Homestead Road					
	North Bound			South Bound			East Bound			West Bound		
Approach:	L	T	R	L	T	R	L	T	R	L	T	R
Min. Green:	7	10	10	7	10	10	7	10	10	7	10	10
Y+R:	4.0	4.0	4.0	4.0	4.0	4.0	4.0	4.0	4.0	4.0	4.0	4.0

Volume Module:												
Base Vol:	208	872	175	101	1080	88	136	440	395	233	500	70
Growth Adj:	1.00	1.00	1.00	1.00	1.00	1.00	1.00	1.00	1.00	1.00	1.00	1.00
Initial Bse:	208	872	175	101	1080	88	136	440	395	233	500	70
Added Vol:	0	0	0	0	0	0	0	0	0	0	0	0
PasserByVol:	230	210	165	19	126	19	29	86	50	109	98	58
Initial Fut:	438	1082	340	120	1206	107	165	526	445	342	598	128
User Adj:	1.00	1.00	1.00	1.00	1.00	1.00	1.00	1.00	1.00	1.00	1.00	1.00
PHF Adj:	1.00	1.00	1.00	1.00	1.00	1.00	1.00	1.00	1.00	1.00	1.00	1.00
PHF Volume:	438	1082	340	120	1206	107	165	526	445	342	598	128
Reduct Vol:	0	0	0	0	0	0	0	0	0	0	0	0
Reduced Vol:	438	1082	340	120	1206	107	165	526	445	342	598	128
PCE Adj:	1.00	1.00	1.00	1.00	1.00	1.00	1.00	1.00	1.00	1.00	1.00	1.00
MLF Adj:	1.00	1.00	1.00	1.00	1.00	1.00	1.00	1.00	1.00	1.00	1.00	1.00
Final Volume:	438	1082	340	120	1206	107	165	526	445	342	598	128

Saturation Flow Module:												
Sat/Lane:	1900	1900	1900	1900	1900	1900	1900	1900	1900	1900	1900	1900
Adjustment:	0.83	1.00	0.92	0.83	0.99	0.95	0.92	1.00	0.92	0.83	0.98	0.95
Lanes:	2.00	2.00	1.00	2.00	2.75	0.25	1.00	2.00	1.00	2.00	1.64	0.36
Final Sat.:	3150	3800	1750	3150	5143	456	1750	3800	1750	3150	3047	652

Capacity Analysis Module:												
Vol/Sat:	0.14	0.28	0.19	0.04	0.23	0.23	0.09	0.14	0.25	0.11	0.20	0.20
Crit Moves:	***			***			***			***		
Green Time:	22.6	50.4	71.2	10.3	38.1	38.1	15.3	26.5	49.1	20.8	31.9	31.9
Volume/Cap:	0.74	0.68	0.33	0.44	0.74	0.74	0.74	0.63	0.62	0.63	0.74	0.74
Delay/Veh:	43.7	15.8	0.5	50.0	26.8	26.8	62.6	43.8	29.8	48.3	43.2	43.2
User DelAdj:	1.00	1.00	1.00	1.00	1.00	1.00	1.00	1.00	1.00	1.00	1.00	1.00
AdjDel/Veh:	43.7	15.8	0.5	50.0	26.8	26.8	62.6	43.8	29.8	48.3	43.2	43.2
LOS by Move:	D	B	A	D	C	C	E	D	C	D	D	D
HCM2kAvgQ:	9	11	0	2	13	13	8	9	13	7	12	12

Note: Queue reported is the number of cars per lane.

Hamptons Apartment Complex TIA
 SJ15-1612
 Background PM

Level Of Service Computation Report
 2000 HCM Operations (Future Volume Alternative)
 Background PP PM

Intersection #5: Wolfe Road / Homestead Road

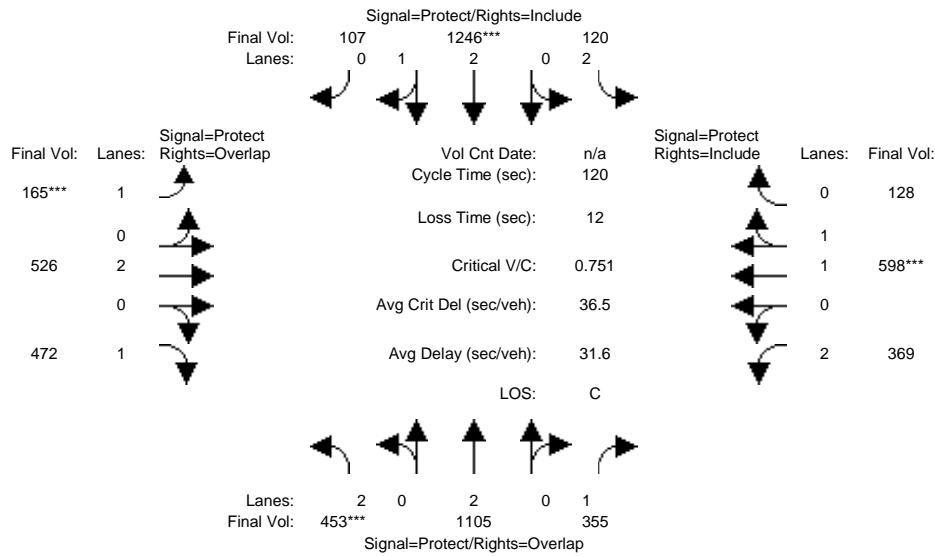

Street Name:	Wolfe Road						Homestead Road					
	North Bound			South Bound			East Bound			West Bound		
Approach:												
Movement:	L	T	R	L	T	R	L	T	R	L	T	R
Min. Green:	7	10	10	7	10	10	7	10	10	7	10	10
Y+R:	4.0	4.0	4.0	4.0	4.0	4.0	4.0	4.0	4.0	4.0	4.0	4.0

Volume Module:												
Base Vol:	208	872	175	101	1080	88	136	440	395	233	500	70
Growth Adj:	1.00	1.00	1.00	1.00	1.00	1.00	1.00	1.00	1.00	1.00	1.00	1.00
Initial Bse:	208	872	175	101	1080	88	136	440	395	233	500	70
Added Vol:	15	23	15	0	40	0	0	0	27	27	0	0
PasserByVol:	230	210	165	19	126	19	29	86	50	109	98	58
Initial Fut:	453	1105	355	120	1246	107	165	526	472	369	598	128
User Adj:	1.00	1.00	1.00	1.00	1.00	1.00	1.00	1.00	1.00	1.00	1.00	1.00
PHF Adj:	1.00	1.00	1.00	1.00	1.00	1.00	1.00	1.00	1.00	1.00	1.00	1.00
PHF Volume:	453	1105	355	120	1246	107	165	526	472	369	598	128
Reduct Vol:	0	0	0	0	0	0	0	0	0	0	0	0
Reduced Vol:	453	1105	355	120	1246	107	165	526	472	369	598	128
PCE Adj:	1.00	1.00	1.00	1.00	1.00	1.00	1.00	1.00	1.00	1.00	1.00	1.00
MLF Adj:	1.00	1.00	1.00	1.00	1.00	1.00	1.00	1.00	1.00	1.00	1.00	1.00
Final Volume:	453	1105	355	120	1246	107	165	526	472	369	598	128

Saturation Flow Module:												
Sat/Lane:	1900	1900	1900	1900	1900	1900	1900	1900	1900	1900	1900	1900
Adjustment:	0.83	1.00	0.92	0.83	0.99	0.95	0.92	1.00	0.92	0.83	0.98	0.95
Lanes:	2.00	2.00	1.00	2.00	2.75	0.25	1.00	2.00	1.00	2.00	1.64	0.36
Final Sat.:	3150	3800	1750	3150	5157	443	1750	3800	1750	3150	3047	652

Capacity Analysis Module:												
Vol/Sat:	0.14	0.29	0.20	0.04	0.24	0.24	0.09	0.14	0.27	0.12	0.20	0.20
Crit Moves:	***			****			****			****		
Green Time:	23.0	51.3	72.6	10.3	38.6	38.6	15.1	25.1	48.1	21.3	31.4	31.4
Volume/Cap:	0.75	0.68	0.34	0.44	0.75	0.75	0.75	0.66	0.67	0.66	0.75	0.75
Delay/Veh:	43.8	15.1	0.2	50.0	26.7	26.7	64.2	45.6	32.1	48.9	44.1	44.1
User DelAdj:	1.00	1.00	1.00	1.00	1.00	1.00	1.00	1.00	1.00	1.00	1.00	1.00
AdjDel/Veh:	43.8	15.1	0.2	50.0	26.7	26.7	64.2	45.6	32.1	48.9	44.1	44.1
LOS by Move:	D	B	A	D	C	C	E	D	C-	D	D	D
HCM2kAvgQ:	9	11	0	2	13	13	8	10	14	7	12	12

Note: Queue reported is the number of cars per lane.

Hamptons Apartment Complex TIA
SJ15-1612
Background PM

Level Of Service Computation Report
2000 HCM Operations (Future Volume Alternative)
Background PM

Intersection #6: Wolfe Road / Apple Campus 2

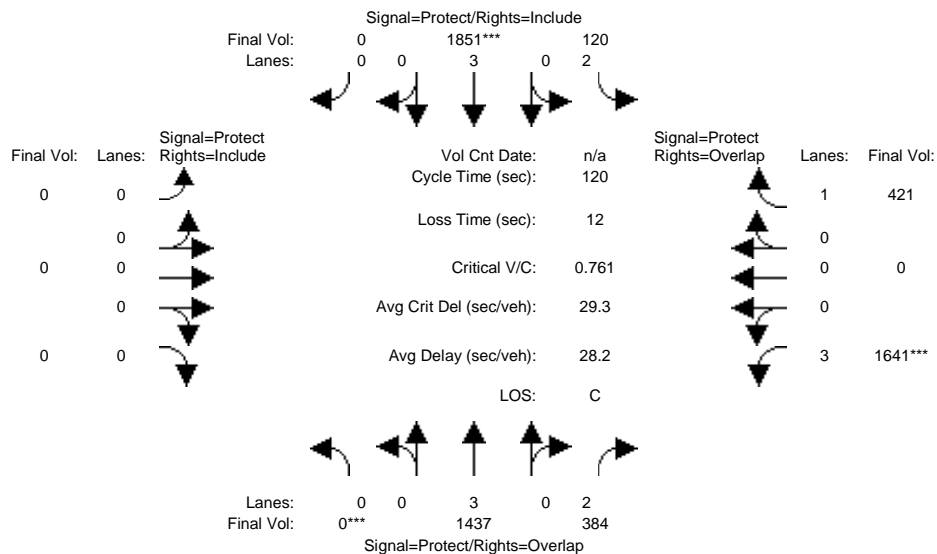

Street Name:	Wolfe Road						Apple Campus 2					
	North Bound			South Bound			East Bound			West Bound		
Approach:	North Bound			South Bound			East Bound			West Bound		
Movement:	L	T	R	L	T	R	L	T	R	L	T	R
Min. Green:	7	10	10	7	10	10	7	10	10	7	10	10
Y+R:	4.0	4.0	4.0	4.0	4.0	4.0	4.0	4.0	4.0	4.0	4.0	4.0

Volume Module:												
Base Vol:	0	1255	0	0	1708	0	0	0	0	0	0	0
Growth Adj:	1.00	1.00	1.00	1.00	1.00	1.00	1.00	1.00	1.00	1.00	1.00	1.00
Initial Bse:	0	1255	0	0	1708	0	0	0	0	0	0	0
Added Vol:	0	0	0	0	0	0	0	0	0	0	0	0
PasserByVol:	0	182	384	120	143	0	0	0	0	1641	0	421
Initial Fut:	0	1437	384	120	1851	0	0	0	0	1641	0	421
User Adj:	1.00	1.00	1.00	1.00	1.00	1.00	1.00	1.00	1.00	1.00	1.00	1.00
PHF Adj:	1.00	1.00	1.00	1.00	1.00	1.00	1.00	1.00	1.00	1.00	1.00	1.00
PHF Volume:	0	1437	384	120	1851	0	0	0	0	1641	0	421
Reduct Vol:	0	0	0	0	0	0	0	0	0	0	0	0
Reduced Vol:	0	1437	384	120	1851	0	0	0	0	1641	0	421
PCE Adj:	1.00	1.00	1.00	1.00	1.00	1.00	1.00	1.00	1.00	1.00	1.00	1.00
MLF Adj:	1.00	1.00	1.00	1.00	1.00	1.00	1.00	1.00	1.00	1.00	1.00	1.00
Final Volume:	0	1437	384	120	1851	0	0	0	0	1641	0	421

Saturation Flow Module:												
Sat/Lane:	1900	1900	1900	1900	1900	1900	1900	1900	1900	1900	1900	1900
Adjustment:	0.92	1.00	0.83	0.83	1.00	0.92	0.92	1.00	0.92	0.80	1.00	0.92
Lanes:	0.00	3.00	2.00	2.00	3.00	0.00	0.00	0.00	0.00	3.00	0.00	1.00
Final Sat.:	0	5700	3150	3150	5700	0	0	0	0	4551	0	1750

Capacity Analysis Module:												
Vol/Sat:	0.00	0.25	0.12	0.04	0.32	0.00	0.00	0.00	0.00	0.36	0.00	0.24
Crit Moves:	***			***						***		
Green Time:	0.0	44.5	101.3	6.7	51.2	0.0	0.0	0.0	0.0	56.8	0.0	63.5
Volume/Cap:	0.00	0.68	0.14	0.68	0.76	0.00	0.00	0.00	0.00	0.76	0.00	0.45
Delay/Veh:	0.0	32.7	1.7	65.9	30.7	0.0	0.0	0.0	0.0	27.7	0.0	17.8
User DelAdj:	1.00	1.00	1.00	1.00	1.00	1.00	1.00	1.00	1.00	1.00	1.00	1.00
AdjDel/Veh:	0.0	32.7	1.7	65.9	30.7	0.0	0.0	0.0	0.0	27.7	0.0	17.8
LOS by Move:	A	C-	A	E	C	A	A	A	A	C	A	B
HCM2kAvgQ:	0	15	2	3	19	0	0	0	0	22	0	10

Note: Queue reported is the number of cars per lane.

Hamptons Apartment Complex TIA
 SJ15-1612
 Background PM

Level Of Service Computation Report
 2000 HCM Operations (Future Volume Alternative)
 Background PP PM

Intersection #6: Wolfe Road / Apple Campus 2

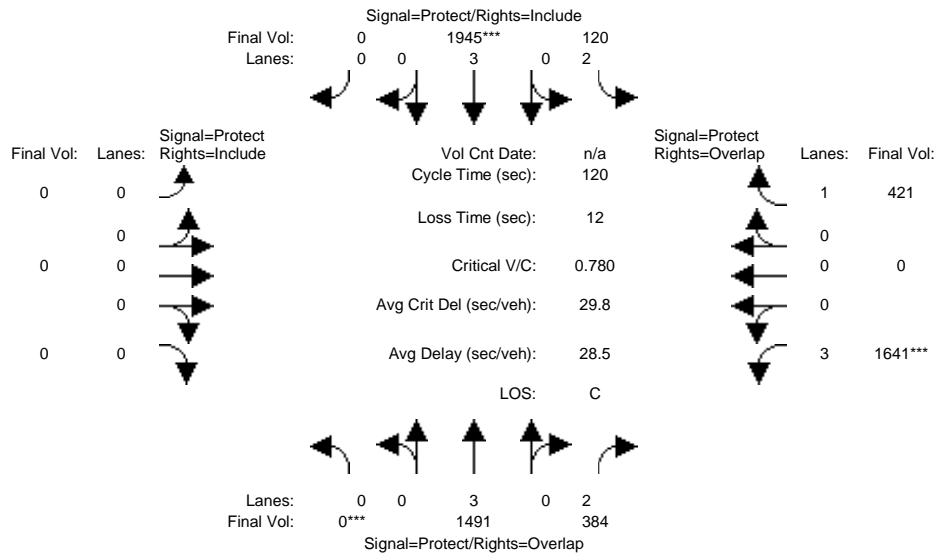

Street Name:	Wolfe Road						Apple Campus 2					
Approach:	North Bound			South Bound			East Bound			West Bound		
Movement:	L	T	R	L	T	R	L	T	R	L	T	R
Min. Green:	7	10	10	7	10	10	7	10	10	7	10	10
Y+R:	4.0	4.0	4.0	4.0	4.0	4.0	4.0	4.0	4.0	4.0	4.0	4.0
Volume Module:												
Base Vol:	0	1255	0	0	1708	0	0	0	0	0	0	0
Growth Adj:	1.00	1.00	1.00	1.00	1.00	1.00	1.00	1.00	1.00	1.00	1.00	1.00
Initial Bse:	0	1255	0	0	1708	0	0	0	0	0	0	0
Added Vol:	0	54	0	0	94	0	0	0	0	0	0	0
PasserByVol:	0	182	384	120	143	0	0	0	0	1641	0	421
Initial Fut:	0	1491	384	120	1945	0	0	0	0	1641	0	421
User Adj:	1.00	1.00	1.00	1.00	1.00	1.00	1.00	1.00	1.00	1.00	1.00	1.00
PHF Adj:	1.00	1.00	1.00	1.00	1.00	1.00	1.00	1.00	1.00	1.00	1.00	1.00
PHF Volume:	0	1491	384	120	1945	0	0	0	0	1641	0	421
Reduct Vol:	0	0	0	0	0	0	0	0	0	0	0	0
Reduced Vol:	0	1491	384	120	1945	0	0	0	0	1641	0	421
PCE Adj:	1.00	1.00	1.00	1.00	1.00	1.00	1.00	1.00	1.00	1.00	1.00	1.00
MLF Adj:	1.00	1.00	1.00	1.00	1.00	1.00	1.00	1.00	1.00	1.00	1.00	1.00
Final Volume:	0	1491	384	120	1945	0	0	0	0	1641	0	421
Saturation Flow Module:												
Sat/Lane:	1900	1900	1900	1900	1900	1900	1900	1900	1900	1900	1900	1900
Adjustment:	0.92	1.00	0.83	0.83	1.00	0.92	0.92	1.00	0.92	0.80	1.00	0.92
Lanes:	0.00	3.00	2.00	2.00	3.00	0.00	0.00	0.00	0.00	3.00	0.00	1.00
Final Sat.:	0	5700	3150	3150	5700	0	0	0	0	4551	0	1750
Capacity Analysis Module:												
Vol/Sat:	0.00	0.26	0.12	0.04	0.34	0.00	0.00	0.00	0.00	0.36	0.00	0.24
Crit Moves:	***			***						***		
Green Time:	0.0	45.8	101.3	6.7	52.5	0.0	0.0	0.0	0.0	55.5	0.0	62.2
Volume/Cap:	0.00	0.68	0.14	0.68	0.78	0.00	0.00	0.00	0.00	0.78	0.00	0.46
Delay/Veh:	0.0	32.0	1.7	66.3	30.4	0.0	0.0	0.0	0.0	29.1	0.0	18.7
User DelAdj:	1.00	1.00	1.00	1.00	1.00	1.00	1.00	1.00	1.00	1.00	1.00	1.00
AdjDel/Veh:	0.0	32.0	1.7	66.3	30.4	0.0	0.0	0.0	0.0	29.1	0.0	18.7
LOS by Move:	A	C	A	E	C	A	A	A	A	C	A	B-
HCM2kAvgQ:	0	15	2	3	20	0	0	0	0	22	0	11

Note: Queue reported is the number of cars per lane.

Hamptons Apartment Complex TIA
SJ15-1612
Background PM

Level Of Service Computation Report
2000 HCM Operations (Future Volume Alternative)
Background PM

Intersection #7: Wolfe Road / Pruneridge Avenue

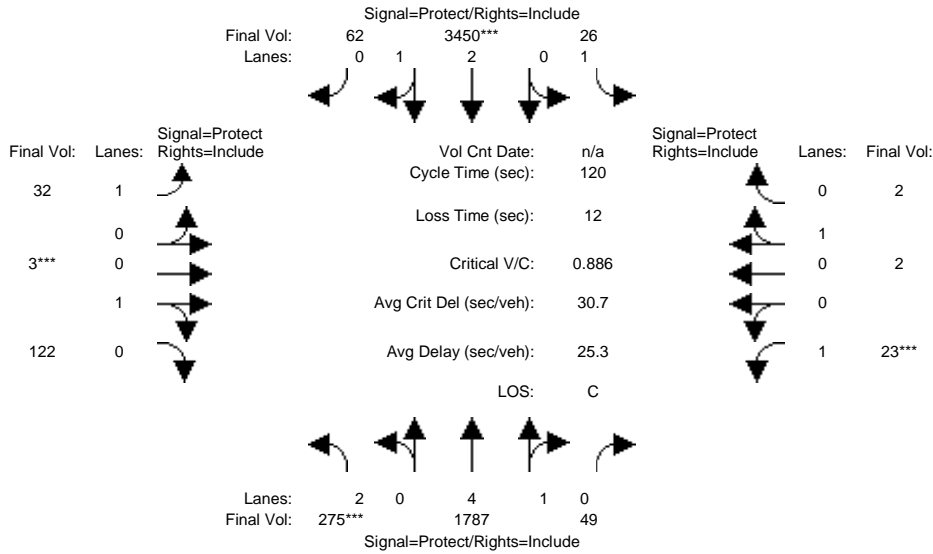

Street Name:	Wolfe Road						Pruneridge Avenue					
Approach:	North Bound			South Bound			East Bound			West Bound		
Movement:	L	T	R	L	T	R	L	T	R	L	T	R
Min. Green:	7	10	10	7	10	10	7	10	10	7	10	10
Y+R:	4.0	4.0	4.0	4.0	4.0	4.0	4.0	4.0	4.0	4.0	4.0	4.0

Volume Module:	North Wolfe			South Wolfe			East Pruneridge			West Pruneridge		
Base Vol:	245	1221	49	25	1622	61	32	3	114	23	2	2
Growth Adj:	1.00	1.00	1.00	1.00	1.00	1.00	1.00	1.00	1.00	1.00	1.00	1.00
Initial Bse:	245	1221	49	25	1622	61	32	3	114	23	2	2
Added Vol:	0	0	0	0	0	0	0	0	0	0	0	0
PasserByVol:	30	566	0	1	1828	1	0	0	8	0	0	0
Initial Fut:	275	1787	49	26	3450	62	32	3	122	23	2	2
User Adj:	1.00	1.00	1.00	1.00	1.00	1.00	1.00	1.00	1.00	1.00	1.00	1.00
PHF Adj:	1.00	1.00	1.00	1.00	1.00	1.00	1.00	1.00	1.00	1.00	1.00	1.00
PHF Volume:	275	1787	49	26	3450	62	32	3	122	23	2	2
Reduct Vol:	0	0	0	0	0	0	0	0	0	0	0	0
Reduced Vol:	275	1787	49	26	3450	62	32	3	122	23	2	2
PCE Adj:	1.00	1.00	1.00	1.00	1.00	1.00	1.00	1.00	1.00	1.00	1.00	1.00
MLF Adj:	1.00	1.00	1.00	1.00	1.00	1.00	1.00	1.00	1.00	1.00	1.00	1.00
Final Volume:	275	1787	49	26	3450	62	32	3	122	23	2	2

Saturation Flow Module:	North Wolfe			South Wolfe			East Pruneridge			West Pruneridge		
Sat/Lane:	1900	1900	1900	1900	1900	1900	1900	1900	1900	1900	1900	1900
Adjustment:	0.83	0.99	0.95	0.92	0.98	0.95	0.92	0.95	0.95	0.92	0.95	0.95
Lanes:	2.00	4.86	0.14	1.00	2.95	0.05	1.00	0.02	0.98	1.00	0.50	0.50
Final Sat.:	3150	9149	251	1750	5501	99	1750	43	1757	1750	900	900

Capacity Analysis Module:	North Wolfe			South Wolfe			East Pruneridge			West Pruneridge		
Vol/Sat:	0.09	0.20	0.20	0.01	0.63	0.63	0.02	0.07	0.07	0.01	0.00	0.00
Crit Moves:	***			****			****			****		
Green Time:	11.1	70.1	70.1	20.9	79.9	79.9	7.0	10.0	10.0	7.0	10.0	10.0
Volume/Cap:	0.94	0.33	0.33	0.09	0.94	0.94	0.31	0.83	0.83	0.23	0.03	0.03
Delay/Veh:	91.5	12.9	12.9	41.6	23.8	23.8	56.0	85.3	85.3	55.0	50.6	50.6
User DelAdj:	1.00	1.00	1.00	1.00	1.00	1.00	1.00	1.00	1.00	1.00	1.00	1.00
AdjDel/Veh:	91.5	12.9	12.9	41.6	23.8	23.8	56.0	85.3	85.3	55.0	50.6	50.6
LOS by Move:	F	B	B	D	C	C	E+	F	F	E+	D	D
HCM2kAvgQ:	7	7	7	1	41	41	2	7	7	1	0	0

Note: Queue reported is the number of cars per lane.

Hamptons Apartment Complex TIA
 SJ15-1612
 Background PM

Level Of Service Computation Report
 2000 HCM Operations (Future Volume Alternative)
 Background PP PM

Intersection #7: Wolfe Road / Pruneridge Avenue

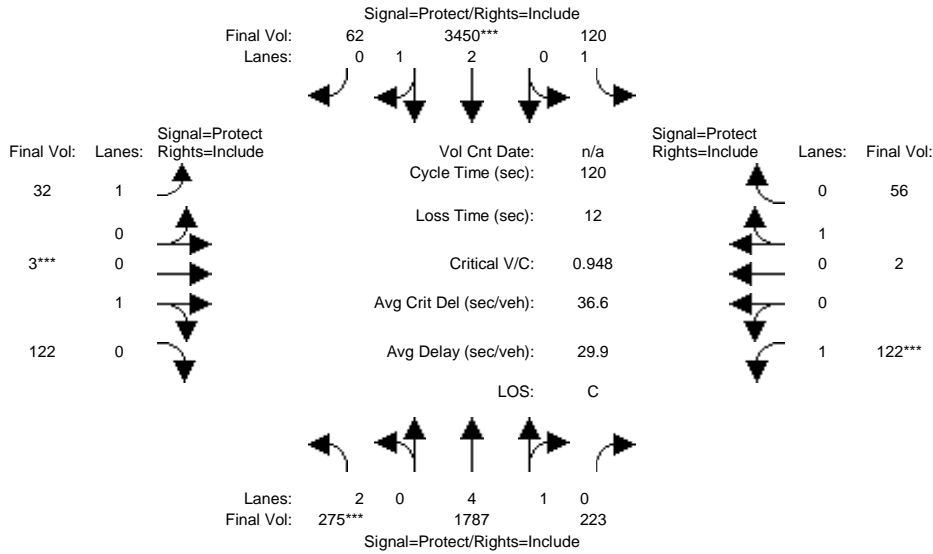

Street Name:	Wolfe Road						Pruneridge Avenue					
	North Bound			South Bound			East Bound			West Bound		
Approach:	L	T	R	L	T	R	L	T	R	L	T	R
Min. Green:	7	10	10	7	10	10	7	10	10	7	10	10
Y+R:	4.0	4.0	4.0	4.0	4.0	4.0	4.0	4.0	4.0	4.0	4.0	4.0

Volume Module:												
Base Vol:	245	1221	49	25	1622	61	32	3	114	23	2	2
Growth Adj:	1.00	1.00	1.00	1.00	1.00	1.00	1.00	1.00	1.00	1.00	1.00	1.00
Initial Bse:	245	1221	49	25	1622	61	32	3	114	23	2	2
Added Vol:	0	0	174	94	0	0	0	0	0	99	0	54
PasserByVol:	30	566	0	1	1828	1	0	0	8	0	0	0
Initial Fut:	275	1787	223	120	3450	62	32	3	122	122	2	56
User Adj:	1.00	1.00	1.00	1.00	1.00	1.00	1.00	1.00	1.00	1.00	1.00	1.00
PHF Adj:	1.00	1.00	1.00	1.00	1.00	1.00	1.00	1.00	1.00	1.00	1.00	1.00
PHF Volume:	275	1787	223	120	3450	62	32	3	122	122	2	56
Reduct Vol:	0	0	0	0	0	0	0	0	0	0	0	0
Reduced Vol:	275	1787	223	120	3450	62	32	3	122	122	2	56
PCE Adj:	1.00	1.00	1.00	1.00	1.00	1.00	1.00	1.00	1.00	1.00	1.00	1.00
MLF Adj:	1.00	1.00	1.00	1.00	1.00	1.00	1.00	1.00	1.00	1.00	1.00	1.00
Final Volume:	275	1787	223	120	3450	62	32	3	122	122	2	56

Saturation Flow Module:												
Sat/Lane:	1900	1900	1900	1900	1900	1900	1900	1900	1900	1900	1900	1900
Adjustment:	0.83	0.99	0.95	0.92	0.98	0.95	0.92	0.95	0.95	0.92	0.95	0.95
Lanes:	2.00	4.42	0.58	1.00	2.95	0.05	1.00	0.02	0.98	1.00	0.03	0.97
Final Sat.:	3150	8355	1043	1750	5501	99	1750	43	1757	1750	62	1738

Capacity Analysis Module:												
Vol/Sat:	0.09	0.21	0.21	0.07	0.63	0.63	0.02	0.07	0.07	0.07	0.03	0.03
Crit Moves:	***			****			****			****		
Green Time:	10.9	67.6	67.6	21.7	78.4	78.4	7.7	10.0	10.0	8.7	11.0	11.0
Volume/Cap:	0.96	0.38	0.38	0.38	0.96	0.96	0.28	0.83	0.83	0.96	0.35	0.35
Delay/Veh:	96.6	14.6	14.6	44.0	27.1	27.1	54.9	85.3	85.3	122.8	52.4	52.4
User DelAdj:	1.00	1.00	1.00	1.00	1.00	1.00	1.00	1.00	1.00	1.00	1.00	1.00
AdjDel/Veh:	96.6	14.6	14.6	44.0	27.1	27.1	54.9	85.3	85.3	122.8	52.4	52.4
LOS by Move:	F	B	B	D	C	C	D-	F	F	F	D-	D-
HCM2kAvgQ:	7	8	8	4	43	43	1	7	7	8	2	2

Note: Queue reported is the number of cars per lane.

Hamptons Apartment Complex TIA
SJ15-1612
Background PM

Level Of Service Computation Report
2000 HCM Operations (Future Volume Alternative)
Background PM

Intersection #8: Wolfe Road / I-280 NB Ramps

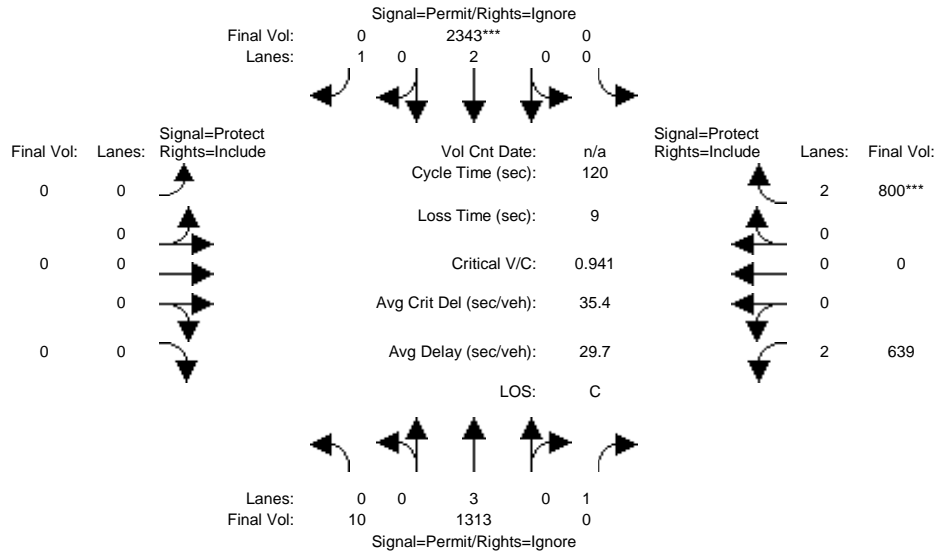

Street Name:	Wolfe Road						I-280 NB Ramps					
Approach:	North Bound			South Bound			East Bound			West Bound		
Movement:	L	T	R	L	T	R	L	T	R	L	T	R
Min. Green:	7	10	10	7	10	10	0	0	0	10	10	10
Y+R:	5.0	5.0	5.0	5.0	5.0	5.0	5.0	5.0	5.0	5.0	5.0	5.0
Volume Module:												
Base Vol:	0	877	465	0	1296	463	0	0	0	580	0	638
Growth Adj:	1.00	1.00	1.00	1.00	1.00	1.00	1.00	1.00	1.00	1.00	1.00	1.00
Initial Bse:	0	877	465	0	1296	463	0	0	0	580	0	638
Added Vol:	0	0	0	0	0	0	0	0	0	0	0	0
PasserByVol:	10	436	388	0	1047	789	0	0	0	59	0	162
Initial Fut:	10	1313	853	0	2343	1252	0	0	0	639	0	800
User Adj:	1.00	1.00	0.00	1.00	1.00	0.00	1.00	1.00	1.00	1.00	1.00	1.00
PHF Adj:	1.00	1.00	0.00	1.00	1.00	0.00	1.00	1.00	1.00	1.00	1.00	1.00
PHF Volume:	10	1313	0	0	2343	0	0	0	0	639	0	800
Reduct Vol:	0	0	0	0	0	0	0	0	0	0	0	0
Reduced Vol:	10	1313	0	0	2343	0	0	0	0	639	0	800
PCE Adj:	1.00	1.00	0.00	1.00	1.00	0.00	1.00	1.00	1.00	1.00	1.00	1.00
MLF Adj:	1.00	1.00	0.00	1.00	1.00	0.00	1.00	1.00	1.00	1.00	1.00	1.00
Final Volume:	10	1313	0	0	2343	0	0	0	0	639	0	800
Saturation Flow Module:												
Sat/Lane:	1900	1900	1900	1900	1900	1900	1900	1900	1900	1900	1900	1900
Adjustment:	0.95	0.98	0.92	0.92	1.00	0.92	0.92	1.00	0.92	0.83	1.00	0.83
Lanes:	0.02	2.98	1.00	0.00	2.00	1.00	0.00	0.00	0.00	2.00	0.00	2.00
Final Sat.:	42	5558	1750	0	3800	1750	0	0	0	3150	0	3150
Capacity Analysis Module:												
Vol/Sat:	0.24	0.24	0.00	0.00	0.62	0.00	0.00	0.00	0.00	0.20	0.00	0.25
Crit Moves:					****							****
Green Time:	78.6	78.6	0.0	0.0	78.6	0.0	0.0	0.0	0.0	32.4	0.0	32.4
Volume/Cap:	0.36	0.36	0.00	0.00	0.94	0.00	0.00	0.00	0.00	0.75	0.00	0.94
Delay/Veh:	9.4	9.4	0.0	0.0	26.6	0.0	0.0	0.0	0.0	43.9	0.0	61.1
User DelAdj:	1.00	1.00	1.00	1.00	1.00	1.00	1.00	1.00	1.00	1.00	1.00	1.00
AdjDel/Veh:	9.4	9.4	0.0	0.0	26.6	0.0	0.0	0.0	0.0	43.9	0.0	61.1
LOS by Move:	A	A	A	A	C	A	A	A	A	D	A	E
HCM2kAvgQ:	0	0	0	0	38	0	0	0	0	14	0	22

Note: Queue reported is the number of cars per lane.

Hamptons Apartment Complex TIA
SJ15-1612
Background PM

Level Of Service Computation Report
2000 HCM Operations (Future Volume Alternative)
Background PP PM

Intersection #8: Wolfe Road / I-280 NB Ramps

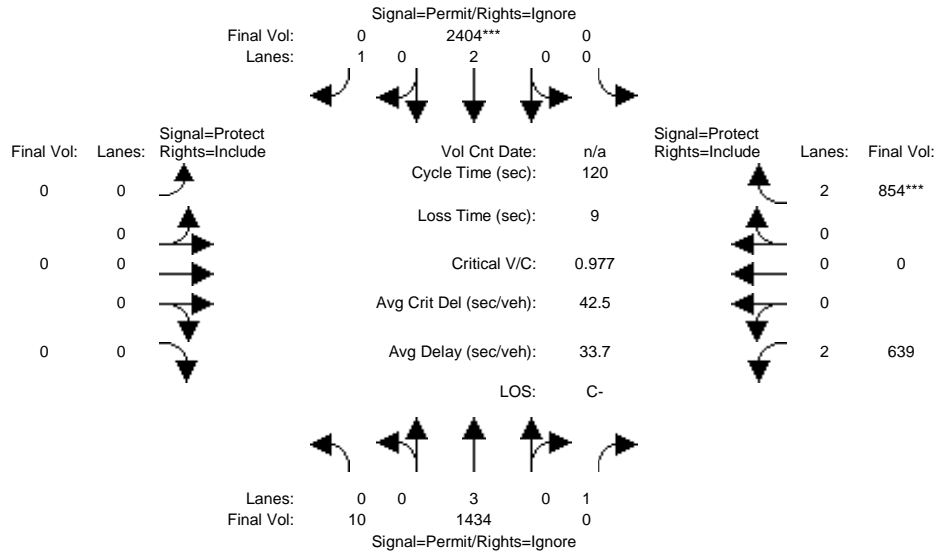

Street Name:	Wolfe Road						I-280 NB Ramps					
Approach:	North Bound			South Bound			East Bound			West Bound		
Movement:	L	T	R	L	T	R	L	T	R	L	T	R
Min. Green:	7	10	10	7	10	10	0	0	0	10	10	10
Y+R:	5.0	5.0	5.0	5.0	5.0	5.0	5.0	5.0	5.0	5.0	5.0	5.0
Volume Module:												
Base Vol:	0	877	465	0	1296	463	0	0	0	580	0	638
Growth Adj:	1.00	1.00	1.00	1.00	1.00	1.00	1.00	1.00	1.00	1.00	1.00	1.00
Initial Bse:	0	877	465	0	1296	463	0	0	0	580	0	638
Added Vol:	0	121	0	0	61	38	0	0	0	0	0	54
PasserByVol:	10	436	388	0	1047	789	0	0	0	59	0	162
Initial Fut:	10	1434	853	0	2404	1290	0	0	0	639	0	854
User Adj:	1.00	1.00	0.00	1.00	1.00	0.00	1.00	1.00	1.00	1.00	1.00	1.00
PHF Adj:	1.00	1.00	0.00	1.00	1.00	0.00	1.00	1.00	1.00	1.00	1.00	1.00
PHF Volume:	10	1434	0	0	2404	0	0	0	0	639	0	854
Reduct Vol:	0	0	0	0	0	0	0	0	0	0	0	0
Reduced Vol:	10	1434	0	0	2404	0	0	0	0	639	0	854
PCE Adj:	1.00	1.00	0.00	1.00	1.00	0.00	1.00	1.00	1.00	1.00	1.00	1.00
MLF Adj:	1.00	1.00	0.00	1.00	1.00	0.00	1.00	1.00	1.00	1.00	1.00	1.00
Final Volume:	10	1434	0	0	2404	0	0	0	0	639	0	854
Saturation Flow Module:												
Sat/Lane:	1900	1900	1900	1900	1900	1900	1900	1900	1900	1900	1900	1900
Adjustment:	0.95	0.98	0.92	0.92	1.00	0.92	0.92	1.00	0.92	0.83	1.00	0.83
Lanes:	0.02	2.98	1.00	0.00	2.00	1.00	0.00	0.00	0.00	2.00	0.00	2.00
Final Sat.:	39	5561	1750	0	3800	1750	0	0	0	3150	0	3150
Capacity Analysis Module:												
Vol/Sat:	0.26	0.26	0.00	0.00	0.63	0.00	0.00	0.00	0.00	0.20	0.00	0.27
Crit Moves:					****							****
Green Time:	77.7	77.7	0.0	0.0	77.7	0.0	0.0	0.0	0.0	33.3	0.0	33.3
Volume/Cap:	0.40	0.40	0.00	0.00	0.98	0.00	0.00	0.00	0.00	0.73	0.00	0.98
Delay/Veh:	10.1	10.1	0.0	0.0	33.5	0.0	0.0	0.0	0.0	42.5	0.0	67.8
User DelAdj:	1.00	1.00	1.00	1.00	1.00	1.00	1.00	1.00	1.00	1.00	1.00	1.00
AdjDel/Veh:	10.1	10.1	0.0	0.0	33.5	0.0	0.0	0.0	0.0	42.5	0.0	67.8
LOS by Move:	B+	B+	A	A	C-	A	A	A	A	D	A	E
HCM2kAvgQ:	0	0	0	0	42	0	0	0	0	14	0	24

Note: Queue reported is the number of cars per lane.

Hamptons Apartment Complex TIA
 SJ15-1612
 Background PM

Level Of Service Computation Report
 2000 HCM Operations (Future Volume Alternative)
 Background PM

Intersection #9: Wolfe Road / I-280 SB Ramps

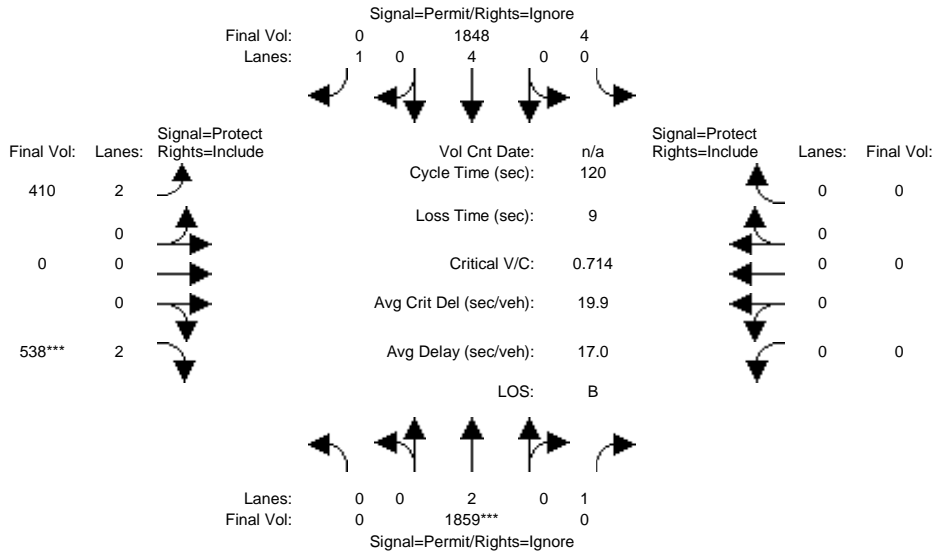

Street Name:	Wolfe Road						I-280 SB Ramps					
Approach:	North Bound			South Bound			East Bound			West Bound		
Movement:	L	T	R	L	T	R	L	T	R	L	T	R
Min. Green:	7	10	10	7	10	10	10	10	10	0	0	0
Y+R:	5.0	5.0	5.0	5.0	5.0	5.0	5.0	5.0	5.0	5.0	5.0	5.0
Volume Module:												
Base Vol:	0	1155	503	0	1394	482	187	0	276	0	0	0
Growth Adj:	1.00	1.00	1.00	1.00	1.00	1.00	1.00	1.00	1.00	1.00	1.00	1.00
Initial Bse:	0	1155	503	0	1394	482	187	0	276	0	0	0
Added Vol:	0	0	0	0	0	0	0	0	0	0	0	0
PasserByVol:	0	704	40	4	454	652	223	0	262	0	0	0
Initial Fut:	0	1859	543	4	1848	1134	410	0	538	0	0	0
User Adj:	1.00	1.00	0.00	1.00	1.00	0.00	1.00	1.00	1.00	1.00	1.00	1.00
PHF Adj:	1.00	1.00	0.00	1.00	1.00	0.00	1.00	1.00	1.00	1.00	1.00	1.00
PHF Volume:	0	1859	0	4	1848	0	410	0	538	0	0	0
Reduct Vol:	0	0	0	0	0	0	0	0	0	0	0	0
Reduced Vol:	0	1859	0	4	1848	0	410	0	538	0	0	0
PCE Adj:	1.00	1.00	0.00	1.00	1.00	0.00	1.00	1.00	1.00	1.00	1.00	1.00
MLF Adj:	1.00	1.00	0.00	1.00	1.00	0.00	1.00	1.00	1.00	1.00	1.00	1.00
Final Volume:	0	1859	0	4	1848	0	410	0	538	0	0	0
Saturation Flow Module:												
Sat/Lane:	1900	1900	1900	1900	1900	1900	1900	1900	1900	1900	1900	1900
Adjustment:	0.92	1.00	0.92	0.95	0.99	0.92	0.83	1.00	0.83	0.92	1.00	0.92
Lanes:	0.00	2.00	1.00	0.01	3.99	1.00	2.00	0.00	2.00	0.00	0.00	0.00
Final Sat.:	0	3800	1750	16	7484	1750	3150	0	3150	0	0	0
Capacity Analysis Module:												
Vol/Sat:	0.00	0.49	0.00	0.25	0.25	0.00	0.13	0.00	0.17	0.00	0.00	0.00
Crit Moves:	****						****					
Green Time:	0.0	82.3	0.0	82.3	82.3	0.0	28.7	0.0	28.7	0.0	0.0	0.0
Volume/Cap:	0.00	0.71	0.00	0.36	0.36	0.00	0.54	0.00	0.71	0.00	0.00	0.00
Delay/Veh:	0.0	12.6	0.0	7.9	7.9	0.0	40.7	0.0	45.1	0.0	0.0	0.0
User DelAdj:	1.00	1.00	1.00	1.00	1.00	1.00	1.00	1.00	1.00	1.00	1.00	1.00
AdjDel/Veh:	0.0	12.6	0.0	7.9	7.9	0.0	40.7	0.0	45.1	0.0	0.0	0.0
LOS by Move:	A	B	A	A	A	A	D	A	D	A	A	A
HCM2kAvgQ:	0	2	0	0	0	0	8	0	12	0	0	0

Note: Queue reported is the number of cars per lane.

Hamptons Apartment Complex TIA
 SJ15-1612
 Background PM

Level Of Service Computation Report
 2000 HCM Operations (Future Volume Alternative)
 Background PP PM

Intersection #9: Wolfe Road / I-280 SB Ramps

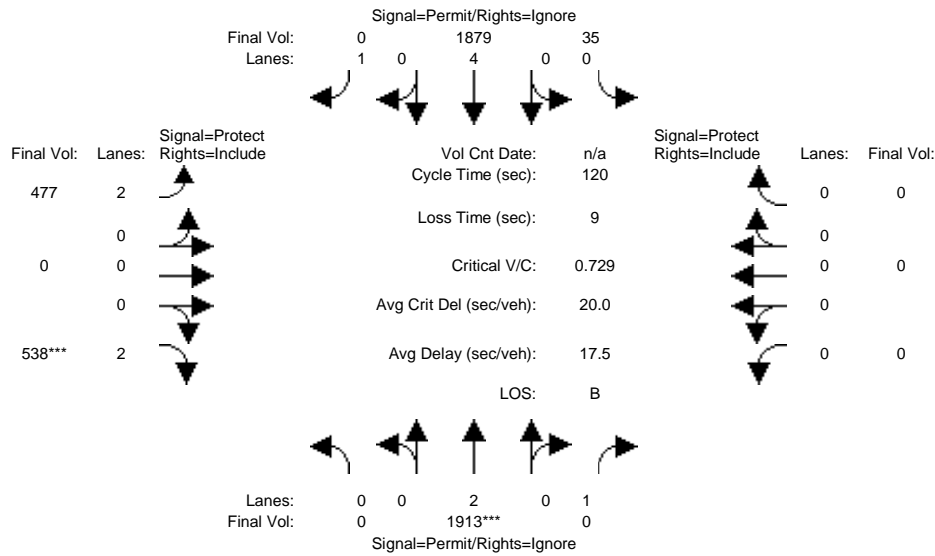

Street Name:	Wolfe Road						I-280 SB Ramps					
Approach:	North Bound			South Bound			East Bound			West Bound		
Movement:	L	T	R	L	T	R	L	T	R	L	T	R
Min. Green:	7	10	10	7	10	10	10	10	10	0	0	0
Y+R:	5.0	5.0	5.0	5.0	5.0	5.0	5.0	5.0	5.0	5.0	5.0	5.0
Volume Module:												
Base Vol:	0	1155	503	0	1394	482	187	0	276	0	0	0
Growth Adj:	1.00	1.00	1.00	1.00	1.00	1.00	1.00	1.00	1.00	1.00	1.00	1.00
Initial Bse:	0	1155	503	0	1394	482	187	0	276	0	0	0
Added Vol:	0	54	0	31	31	0	67	0	0	0	0	0
PasserByVol:	0	704	40	4	454	652	223	0	262	0	0	0
Initial Fut:	0	1913	543	35	1879	1134	477	0	538	0	0	0
User Adj:	1.00	1.00	0.00	1.00	1.00	0.00	1.00	1.00	1.00	1.00	1.00	1.00
PHF Adj:	1.00	1.00	0.00	1.00	1.00	0.00	1.00	1.00	1.00	1.00	1.00	1.00
PHF Volume:	0	1913	0	35	1879	0	477	0	538	0	0	0
Reduct Vol:	0	0	0	0	0	0	0	0	0	0	0	0
Reduced Vol:	0	1913	0	35	1879	0	477	0	538	0	0	0
PCE Adj:	1.00	1.00	0.00	1.00	1.00	0.00	1.00	1.00	1.00	1.00	1.00	1.00
MLF Adj:	1.00	1.00	0.00	1.00	1.00	0.00	1.00	1.00	1.00	1.00	1.00	1.00
Final Volume:	0	1913	0	35	1879	0	477	0	538	0	0	0
Saturation Flow Module:												
Sat/Lane:	1900	1900	1900	1900	1900	1900	1900	1900	1900	1900	1900	1900
Adjustment:	0.92	1.00	0.92	0.95	0.99	0.92	0.83	1.00	0.83	0.92	1.00	0.92
Lanes:	0.00	2.00	1.00	0.08	3.92	1.00	2.00	0.00	2.00	0.00	0.00	0.00
Final Sat.:	0	3800	1750	137	7363	1750	3150	0	3150	0	0	0
Capacity Analysis Module:												
Vol/Sat:	0.00	0.50	0.00	0.26	0.26	0.00	0.15	0.00	0.17	0.00	0.00	0.00
Crit Moves:	****						****					
Green Time:	0.0	82.9	0.0	82.9	82.9	0.0	28.1	0.0	28.1	0.0	0.0	0.0
Volume/Cap:	0.00	0.73	0.00	0.37	0.37	0.00	0.65	0.00	0.73	0.00	0.00	0.00
Delay/Veh:	0.0	12.6	0.0	7.8	7.8	0.0	43.5	0.0	46.1	0.0	0.0	0.0
User DelAdj:	1.00	1.00	1.00	1.00	1.00	1.00	1.00	1.00	1.00	1.00	1.00	1.00
AdjDel/Veh:	0.0	12.6	0.0	7.8	7.8	0.0	43.5	0.0	46.1	0.0	0.0	0.0
LOS by Move:	A	B	A	A	A	A	D	A	D	A	A	A
HCM2kAvgQ:	0	2	0	0	0	0	10	0	12	0	0	0

Note: Queue reported is the number of cars per lane.

Hamptons Apartment Complex TIA
SJ15-1612
Background PM

Level Of Service Computation Report
2000 HCM Operations (Future Volume Alternative)
Background PM

Intersection #10: Wolfe Road / Vallco Parkway

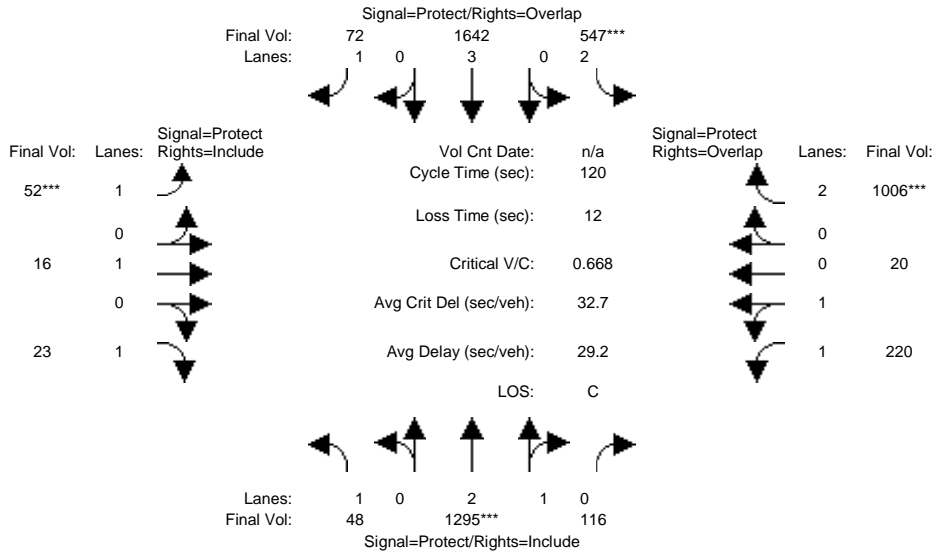

Street Name:	Wolfe Road						Vallco Parkway					
	North Bound			South Bound			East Bound			West Bound		
Approach:	North Bound			South Bound			East Bound			West Bound		
Movement:	L	T	R	L	T	R	L	T	R	L	T	R
Min. Green:	7	10	10	7	10	10	7	10	10	7	10	10
Y+R:	4.0	4.0	4.0	4.0	4.0	4.0	4.0	4.0	4.0	4.0	4.0	4.0

Volume Module:												
Base Vol:	48	1094	72	181	1326	72	52	16	23	184	20	467
Growth Adj:	1.00	1.00	1.00	1.00	1.00	1.00	1.00	1.00	1.00	1.00	1.00	1.00
Initial Bse:	48	1094	72	181	1326	72	52	16	23	184	20	467
Added Vol:	0	0	0	0	0	0	0	0	0	0	0	0
PasserByVol:	0	201	44	366	316	0	0	0	0	36	0	539
Initial Fut:	48	1295	116	547	1642	72	52	16	23	220	20	1006
User Adj:	1.00	1.00	1.00	1.00	1.00	1.00	1.00	1.00	1.00	1.00	1.00	1.00
PHF Adj:	1.00	1.00	1.00	1.00	1.00	1.00	1.00	1.00	1.00	1.00	1.00	1.00
PHF Volume:	48	1295	116	547	1642	72	52	16	23	220	20	1006
Reduct Vol:	0	0	0	0	0	0	0	0	0	0	0	0
Reduced Vol:	48	1295	116	547	1642	72	52	16	23	220	20	1006
PCE Adj:	1.00	1.00	1.00	1.00	1.00	1.00	1.00	1.00	1.00	1.00	1.00	1.00
MLF Adj:	1.00	1.00	1.00	1.00	1.00	1.00	1.00	1.00	1.00	1.00	1.00	1.00
Final Volume:	48	1295	116	547	1642	72	52	16	23	220	20	1006

Saturation Flow Module:												
Sat/Lane:	1900	1900	1900	1900	1900	1900	1900	1900	1900	1900	1900	1900
Adjustment:	0.92	0.99	0.95	0.83	1.00	0.92	0.92	1.00	0.92	0.93	0.95	0.83
Lanes:	1.00	2.74	0.26	2.00	3.00	1.00	1.00	1.00	1.00	1.84	0.16	2.00
Final Sat.:	1750	5139	460	3150	5700	1750	1750	1900	1750	3254	296	3150

Capacity Analysis Module:												
Vol/Sat:	0.03	0.25	0.25	0.17	0.29	0.04	0.03	0.01	0.01	0.07	0.07	0.32
Crit Moves:	****			****			****			****		
Green Time:	12.7	44.5	44.5	30.7	62.6	69.6	7.0	18.1	18.1	14.7	25.8	56.5
Volume/Cap:	0.26	0.68	0.68	0.68	0.55	0.07	0.51	0.06	0.09	0.55	0.31	0.68
Delay/Veh:	50.1	32.6	32.6	42.6	19.5	11.1	59.1	43.7	44.0	51.1	39.9	26.0
User DelAdj:	1.00	1.00	1.00	1.00	1.00	1.00	1.00	1.00	1.00	1.00	1.00	1.00
AdjDel/Veh:	50.1	32.6	32.6	42.6	19.5	11.1	59.1	43.7	44.0	51.1	39.9	26.0
LOS by Move:	D	C-	C-	D	B-	B+	E+	D	D	D-	D	C
HCM2kAvgQ:	2	14	14	11	13	1	3	1	1	4	4	17

Note: Queue reported is the number of cars per lane.

Hamptons Apartment Complex TIA
SJ15-1612
Background PM

Level Of Service Computation Report
2000 HCM Operations (Future Volume Alternative)
Background PP PM

Intersection #10: Wolfe Road / Vallco Parkway

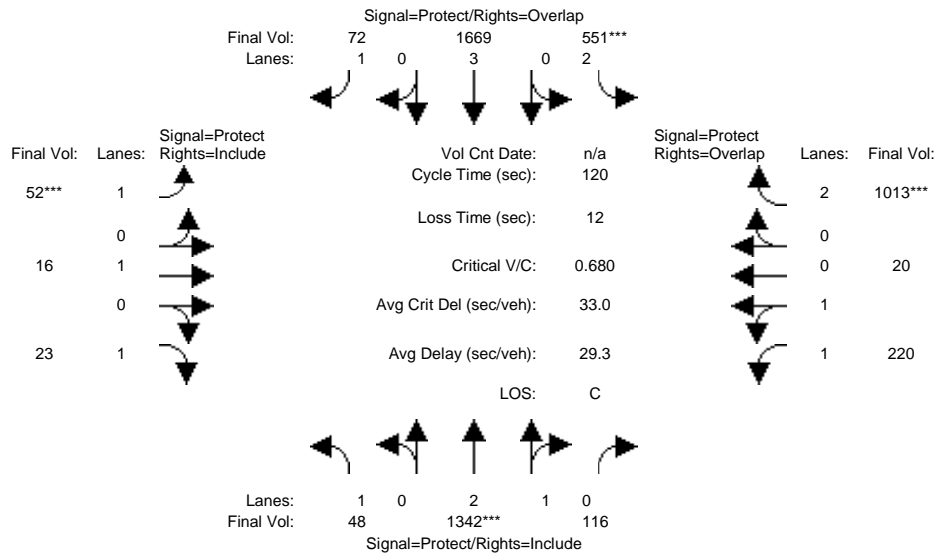

Street Name:	Wolfe Road						Vallco Parkway					
Approach:	North Bound			South Bound			East Bound			West Bound		
Movement:	L	T	R	L	T	R	L	T	R	L	T	R
Min. Green:	7	10	10	7	10	10	7	10	10	7	10	10
Y+R:	4.0	4.0	4.0	4.0	4.0	4.0	4.0	4.0	4.0	4.0	4.0	4.0
Volume Module:												
Base Vol:	48	1094	72	181	1326	72	52	16	23	184	20	467
Growth Adj:	1.00	1.00	1.00	1.00	1.00	1.00	1.00	1.00	1.00	1.00	1.00	1.00
Initial Bse:	48	1094	72	181	1326	72	52	16	23	184	20	467
Added Vol:	0	47	0	4	27	0	0	0	0	0	0	7
PasserByVol:	0	201	44	366	316	0	0	0	0	36	0	539
Initial Fut:	48	1342	116	551	1669	72	52	16	23	220	20	1013
User Adj:	1.00	1.00	1.00	1.00	1.00	1.00	1.00	1.00	1.00	1.00	1.00	1.00
PHF Adj:	1.00	1.00	1.00	1.00	1.00	1.00	1.00	1.00	1.00	1.00	1.00	1.00
PHF Volume:	48	1342	116	551	1669	72	52	16	23	220	20	1013
Reduct Vol:	0	0	0	0	0	0	0	0	0	0	0	0
Reduced Vol:	48	1342	116	551	1669	72	52	16	23	220	20	1013
PCE Adj:	1.00	1.00	1.00	1.00	1.00	1.00	1.00	1.00	1.00	1.00	1.00	1.00
MLF Adj:	1.00	1.00	1.00	1.00	1.00	1.00	1.00	1.00	1.00	1.00	1.00	1.00
Final Volume:	48	1342	116	551	1669	72	52	16	23	220	20	1013
Saturation Flow Module:												
Sat/Lane:	1900	1900	1900	1900	1900	1900	1900	1900	1900	1900	1900	1900
Adjustment:	0.92	0.99	0.95	0.83	1.00	0.92	0.92	1.00	0.92	0.93	0.95	0.83
Lanes:	1.00	2.75	0.25	2.00	3.00	1.00	1.00	1.00	1.00	1.84	0.16	2.00
Final Sat.:	1750	5154	445	3150	5700	1750	1750	1900	1750	3254	296	3150
Capacity Analysis Module:												
Vol/Sat:	0.03	0.26	0.26	0.17	0.29	0.04	0.03	0.01	0.01	0.07	0.07	0.32
Crit Moves:	****			****			****			****		
Green Time:	12.6	45.2	45.2	30.4	63.0	70.0	7.0	17.9	17.9	14.5	25.5	55.8
Volume/Cap:	0.26	0.69	0.69	0.69	0.56	0.07	0.51	0.06	0.09	0.56	0.32	0.69
Delay/Veh:	50.2	32.5	32.5	43.2	19.4	10.9	59.1	43.9	44.1	51.3	40.2	26.7
User DelAdj:	1.00	1.00	1.00	1.00	1.00	1.00	1.00	1.00	1.00	1.00	1.00	1.00
AdjDel/Veh:	50.2	32.5	32.5	43.2	19.4	10.9	59.1	43.9	44.1	51.3	40.2	26.7
LOS by Move:	D	C-	C-	D	B-	B+	E+	D	D	D-	D	C
HCM2kAvgQ:	2	14	14	11	13	1	3	1	1	4	4	18

Note: Queue reported is the number of cars per lane.

Hamptons Apartment Complex TIA
 SJ15-1612
 Background PM

Level Of Service Computation Report
 2000 HCM Operations (Future Volume Alternative)
 Background PM

Intersection #11: Wolfe Road / Stevens Creek Boulevard

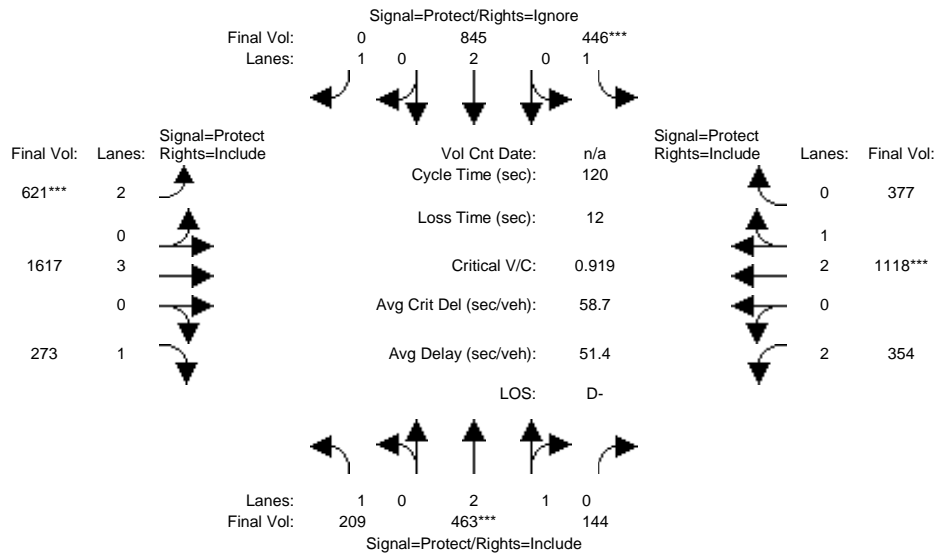

Street Name:	Wolfe Road						Stevens Creek Boulevard					
	North Bound			South Bound			East Bound			West Bound		
Approach:	North Bound			South Bound			East Bound			West Bound		
Movement:	L	T	R	L	T	R	L	T	R	L	T	R
Min. Green:	7	10	10	7	10	10	7	10	10	7	10	10
Y+R:	5.0	5.0	5.0	5.0	5.0	5.0	5.0	5.0	5.0	5.0	5.0	5.0

Volume Module:												
Base Vol:	206	415	98	307	784	443	563	1300	272	262	782	236
Growth Adj:	1.00	1.00	1.00	1.00	1.00	1.00	1.00	1.00	1.00	1.00	1.00	1.00
Initial Bse:	206	415	98	307	784	443	563	1300	272	262	782	236
Added Vol:	0	0	0	0	0	0	0	0	0	0	0	0
PasserByVol:	3	48	46	139	61	155	58	317	1	92	336	141
Initial Fut:	209	463	144	446	845	598	621	1617	273	354	1118	377
User Adj:	1.00	1.00	1.00	1.00	1.00	0.00	1.00	1.00	1.00	1.00	1.00	1.00
PHF Adj:	1.00	1.00	1.00	1.00	1.00	0.00	1.00	1.00	1.00	1.00	1.00	1.00
PHF Volume:	209	463	144	446	845	0	621	1617	273	354	1118	377
Reduct Vol:	0	0	0	0	0	0	0	0	0	0	0	0
Reduced Vol:	209	463	144	446	845	0	621	1617	273	354	1118	377
PCE Adj:	1.00	1.00	1.00	1.00	1.00	0.00	1.00	1.00	1.00	1.00	1.00	1.00
MLF Adj:	1.00	1.00	1.00	1.00	1.00	0.00	1.00	1.00	1.00	1.00	1.00	1.00
Final Volume:	209	463	144	446	845	0	621	1617	273	354	1118	377

Saturation Flow Module:												
Sat/Lane:	1900	1900	1900	1900	1900	1900	1900	1900	1900	1900	1900	1900
Adjustment:	0.92	0.99	0.95	0.92	1.00	0.92	0.83	1.00	0.92	0.83	0.99	0.95
Lanes:	1.00	2.26	0.74	1.00	2.00	1.00	2.00	3.00	1.00	2.00	2.22	0.78
Final Sat.:	1750	4270	1328	1750	3800	1750	3150	5700	1750	3150	4186	1412

Capacity Analysis Module:												
Vol/Sat:	0.12	0.11	0.11	0.25	0.22	0.00	0.20	0.28	0.16	0.11	0.27	0.27
Crit Moves:	****			****			****			****		
Green Time:	16.6	14.2	14.2	33.3	30.8	0.0	25.7	43.4	43.4	17.2	34.9	34.9
Volume/Cap:	0.87	0.92	0.92	0.92	0.87	0.00	0.92	0.78	0.43	0.78	0.92	0.92
Delay/Veh:	76.8	70.4	70.4	64.8	50.8	0.0	63.9	36.2	29.4	58.4	50.1	50.1
User DelAdj:	1.00	1.00	1.00	1.00	1.00	1.00	1.00	1.00	1.00	1.00	1.00	1.00
AdjDel/Veh:	76.8	70.4	70.4	64.8	50.8	0.0	63.9	36.2	29.4	58.4	50.1	50.1
LOS by Move:	E-	E	E	E	D	A	E	D+	C	E+	D	D
HCM2kAvgQ:	11	11	11	19	15	0	14	15	6	7	18	18

Note: Queue reported is the number of cars per lane.

Hamptons Apartment Complex TIA
SJ15-1612
Background PM

Level Of Service Computation Report
2000 HCM Operations (Future Volume Alternative)
Background PP PM

Intersection #11: Wolfe Road / Stevens Creek Boulevard

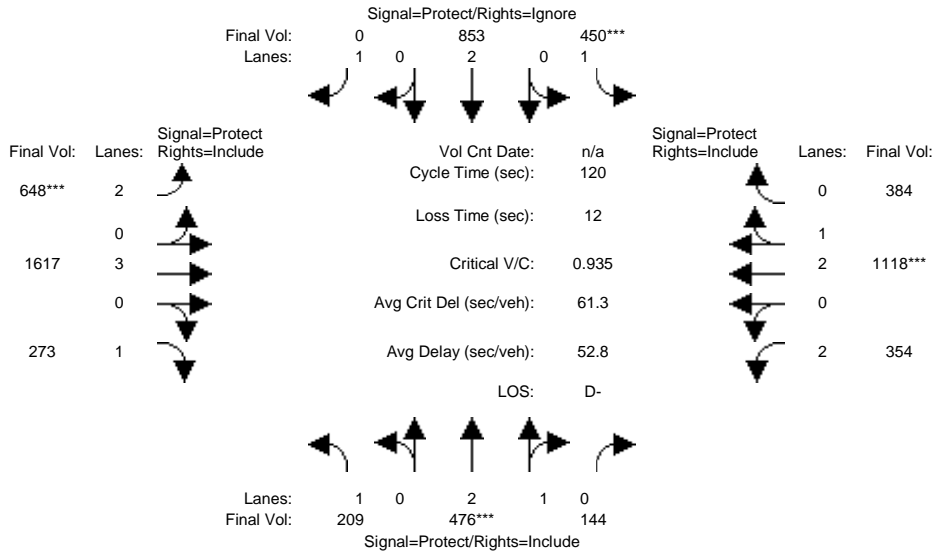

Street Name:	Wolfe Road						Stevens Creek Boulevard					
	North Bound			South Bound			East Bound			West Bound		
	L	T	R	L	T	R	L	T	R	L	T	R
Min. Green:	7	10	10	7	10	10	7	10	10	7	10	10
Y+R:	5.0	5.0	5.0	5.0	5.0	5.0	5.0	5.0	5.0	5.0	5.0	5.0

Volume Module:												
Base Vol:	206	415	98	307	784	443	563	1300	272	262	782	236
Growth Adj:	1.00	1.00	1.00	1.00	1.00	1.00	1.00	1.00	1.00	1.00	1.00	1.00
Initial Bse:	206	415	98	307	784	443	563	1300	272	262	782	236
Added Vol:	0	13	0	4	8	15	27	0	0	0	0	7
PasserByVol:	3	48	46	139	61	155	58	317	1	92	336	141
Initial Fut:	209	476	144	450	853	613	648	1617	273	354	1118	384
User Adj:	1.00	1.00	1.00	1.00	1.00	0.00	1.00	1.00	1.00	1.00	1.00	1.00
PHF Adj:	1.00	1.00	1.00	1.00	1.00	0.00	1.00	1.00	1.00	1.00	1.00	1.00
PHF Volume:	209	476	144	450	853	0	648	1617	273	354	1118	384
Reduct Vol:	0	0	0	0	0	0	0	0	0	0	0	0
Reduced Vol:	209	476	144	450	853	0	648	1617	273	354	1118	384
PCE Adj:	1.00	1.00	1.00	1.00	1.00	0.00	1.00	1.00	1.00	1.00	1.00	1.00
MLF Adj:	1.00	1.00	1.00	1.00	1.00	0.00	1.00	1.00	1.00	1.00	1.00	1.00
Final Volume:	209	476	144	450	853	0	648	1617	273	354	1118	384

Saturation Flow Module:												
Sat/Lane:	1900	1900	1900	1900	1900	1900	1900	1900	1900	1900	1900	1900
Adjustment:	0.92	0.99	0.95	0.92	1.00	0.92	0.83	1.00	0.92	0.83	0.99	0.95
Lanes:	1.00	2.28	0.72	1.00	2.00	1.00	2.00	3.00	1.00	2.00	2.20	0.80
Final Sat.:	1750	4298	1300	1750	3800	1750	3150	5700	1750	3150	4166	1431

Capacity Analysis Module:												
Vol/Sat:	0.12	0.11	0.11	0.26	0.22	0.00	0.21	0.28	0.16	0.11	0.27	0.27
Crit Moves:	****			****			****			****		
Green Time:	16.4	14.2	14.2	33.0	30.8	0.0	26.4	43.6	43.6	17.3	34.4	34.4
Volume/Cap:	0.87	0.94	0.94	0.94	0.87	0.00	0.94	0.78	0.43	0.78	0.94	0.94
Delay/Veh:	78.8	73.1	73.1	68.2	51.6	0.0	66.0	36.0	29.3	58.1	52.4	52.4
User DelAdj:	1.00	1.00	1.00	1.00	1.00	1.00	1.00	1.00	1.00	1.00	1.00	1.00
AdjDel/Veh:	78.8	73.1	73.1	68.2	51.6	0.0	66.0	36.0	29.3	58.1	52.4	52.4
LOS by Move:	E-	E	E	E	D-	A	E	D+	C	E+	D-	D-
HCM2kAvgQ:	11	11	11	19	16	0	15	15	6	7	18	18

Note: Queue reported is the number of cars per lane.

Hamptons Apartment Complex TIA
 SJ15-1612
 Background PM

Level Of Service Computation Report
 2000 HCM Operations (Future Volume Alternative)
 Background PM

Intersection #12: De Anza Boulevard / Stevens Creek Boulevard

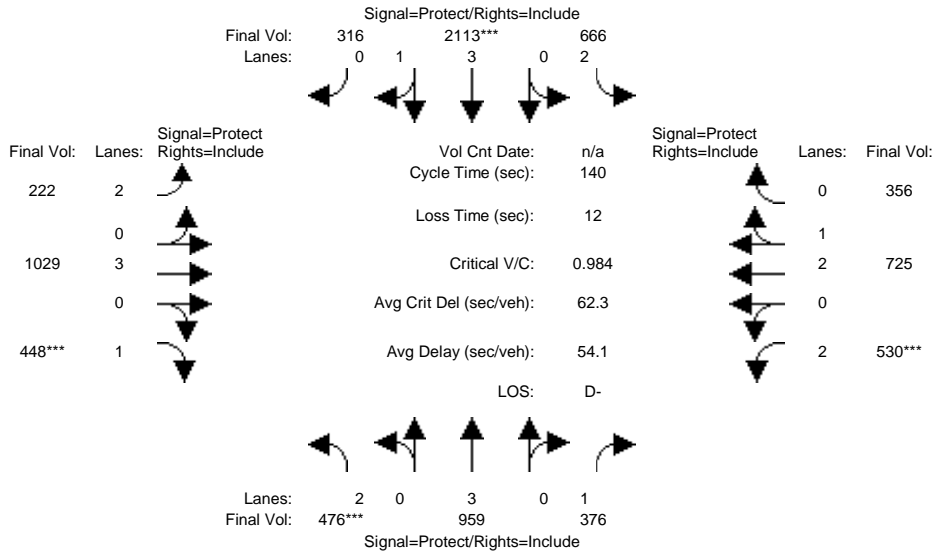

Street Name:	De Anza Boulevard						Stevens Creek Boulevard					
	North Bound			South Bound			East Bound			West Bound		
Approach:	North Bound			South Bound			East Bound			West Bound		
Movement:	L	T	R	L	T	R	L	T	R	L	T	R
Min. Green:	7	10	10	7	10	10	7	10	10	7	10	10
Y+R:	5.0	5.0	5.0	5.0	5.0	5.0	5.0	5.0	5.0	5.0	5.0	5.0

Volume Module:												
Base Vol:	470	825	277	521	1844	289	208	985	440	382	636	270
Growth Adj:	1.00	1.00	1.00	1.00	1.00	1.00	1.00	1.00	1.00	1.00	1.00	1.00
Initial Bse:	470	825	277	521	1844	289	208	985	440	382	636	270
Added Vol:	0	0	0	0	0	0	0	0	0	0	0	0
PasserByVol:	6	134	99	145	269	27	14	44	8	148	89	86
Initial Fut:	476	959	376	666	2113	316	222	1029	448	530	725	356
User Adj:	1.00	1.00	1.00	1.00	1.00	1.00	1.00	1.00	1.00	1.00	1.00	1.00
PHF Adj:	1.00	1.00	1.00	1.00	1.00	1.00	1.00	1.00	1.00	1.00	1.00	1.00
PHF Volume:	476	959	376	666	2113	316	222	1029	448	530	725	356
Reduct Vol:	0	0	0	0	0	0	0	0	0	0	0	0
Reduced Vol:	476	959	376	666	2113	316	222	1029	448	530	725	356
PCE Adj:	1.00	1.00	1.00	1.00	1.00	1.00	1.00	1.00	1.00	1.00	1.00	1.00
MLF Adj:	1.00	1.00	1.00	1.00	1.00	1.00	1.00	1.00	1.00	1.00	1.00	1.00
Final Volume:	476	959	376	666	2113	316	222	1029	448	530	725	356

Saturation Flow Module:												
Sat/Lane:	1900	1900	1900	1900	1900	1900	1900	1900	1900	1900	1900	1900
Adjustment:	0.83	1.00	0.92	0.83	0.99	0.95	0.83	1.00	0.92	0.83	1.00	0.95
Lanes:	2.00	3.00	1.00	2.00	3.46	0.54	2.00	3.00	1.00	2.00	2.00	1.00
Final Sat.:	3150	5700	1750	3150	6523	975	3150	5700	1750	3150	3799	1800

Capacity Analysis Module:												
Vol/Sat:	0.15	0.17	0.21	0.21	0.32	0.32	0.07	0.18	0.26	0.17	0.19	0.20
Crit Moves:	***			***			***			***		
Green Time:	21.5	34.1	34.1	33.5	46.1	46.1	15.9	36.4	36.4	23.9	44.5	44.5
Volume/Cap:	0.98	0.69	0.88	0.88	0.98	0.98	0.62	0.69	0.98	0.98	0.60	0.62
Delay/Veh:	88.4	39.4	59.1	52.4	45.7	45.7	62.6	48.2	89.2	92.3	40.8	41.3
User DelAdj:	1.00	1.00	1.00	1.00	1.00	1.00	1.00	1.00	1.00	1.00	1.00	1.00
AdjDel/Veh:	88.4	39.4	59.1	52.4	45.7	45.7	62.6	48.2	89.2	92.3	40.8	41.3
LOS by Move:	F	D	E+	D-	D	D	E	D	F	F	D	D
HCM2kAvgQ:	17	12	19	19	32	32	6	14	26	14	11	12

Note: Queue reported is the number of cars per lane.

Hamptons Apartment Complex TIA
 SJ15-1612
 Background PM

Level Of Service Computation Report
 2000 HCM Operations (Future Volume Alternative)
 Background PP PM

Intersection #12: De Anza Boulevard / Stevens Creek Boulevard

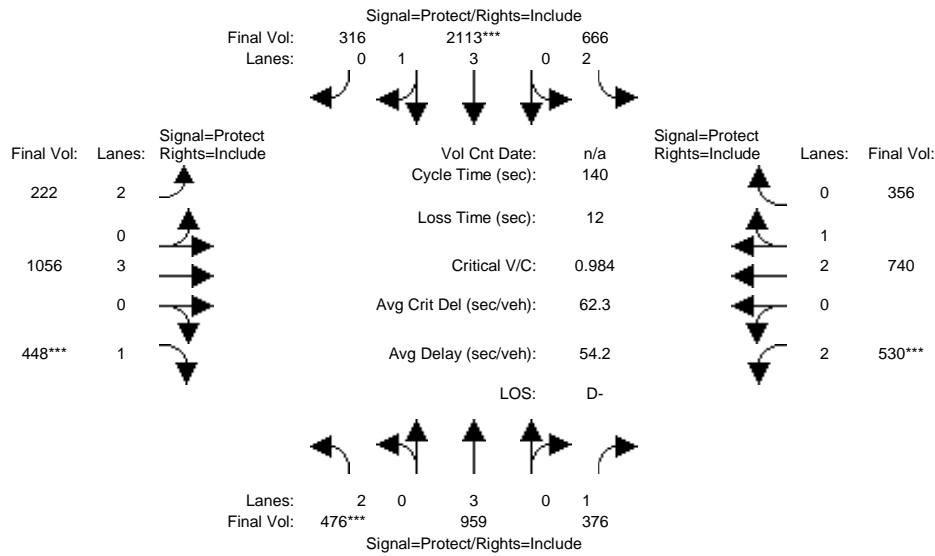

Street Name:	De Anza Boulevard						Stevens Creek Boulevard					
	North Bound			South Bound			East Bound			West Bound		
Approach:												
Movement:	L	T	R	L	T	R	L	T	R	L	T	R
Min. Green:	7	10	10	7	10	10	7	10	10	7	10	10
Y+R:	5.0	5.0	5.0	5.0	5.0	5.0	5.0	5.0	5.0	5.0	5.0	5.0

Volume Module:												
Base Vol:	470	825	277	521	1844	289	208	985	440	382	636	270
Growth Adj:	1.00	1.00	1.00	1.00	1.00	1.00	1.00	1.00	1.00	1.00	1.00	1.00
Initial Bse:	470	825	277	521	1844	289	208	985	440	382	636	270
Added Vol:	0	0	0	0	0	0	0	27	0	0	15	0
PasserByVol:	6	134	99	145	269	27	14	44	8	148	89	86
Initial Fut:	476	959	376	666	2113	316	222	1056	448	530	740	356
User Adj:	1.00	1.00	1.00	1.00	1.00	1.00	1.00	1.00	1.00	1.00	1.00	1.00
PHF Adj:	1.00	1.00	1.00	1.00	1.00	1.00	1.00	1.00	1.00	1.00	1.00	1.00
PHF Volume:	476	959	376	666	2113	316	222	1056	448	530	740	356
Reduct Vol:	0	0	0	0	0	0	0	0	0	0	0	0
Reduced Vol:	476	959	376	666	2113	316	222	1056	448	530	740	356
PCE Adj:	1.00	1.00	1.00	1.00	1.00	1.00	1.00	1.00	1.00	1.00	1.00	1.00
MLF Adj:	1.00	1.00	1.00	1.00	1.00	1.00	1.00	1.00	1.00	1.00	1.00	1.00
Final Volume:	476	959	376	666	2113	316	222	1056	448	530	740	356

Saturation Flow Module:												
Sat/Lane:	1900	1900	1900	1900	1900	1900	1900	1900	1900	1900	1900	1900
Adjustment:	0.83	1.00	0.92	0.83	0.99	0.95	0.83	1.00	0.92	0.83	1.00	0.95
Lanes:	2.00	3.00	1.00	2.00	3.46	0.54	2.00	3.00	1.00	2.00	2.00	1.00
Final Sat.:	3150	5700	1750	3150	6523	975	3150	5700	1750	3150	3797	1800

Capacity Analysis Module:												
Vol/Sat:	0.15	0.17	0.21	0.21	0.32	0.32	0.07	0.19	0.26	0.17	0.19	0.20
Crit Moves:	***			***					***	***		
Green Time:	21.5	34.1	34.1	33.5	46.1	46.1	15.9	36.4	36.4	23.9	44.5	44.5
Volume/Cap:	0.98	0.69	0.88	0.88	0.98	0.98	0.62	0.71	0.98	0.98	0.61	0.62
Delay/Veh:	88.4	39.4	59.1	52.4	45.7	45.7	62.6	48.7	89.2	92.3	41.1	41.3
User DelAdj:	1.00	1.00	1.00	1.00	1.00	1.00	1.00	1.00	1.00	1.00	1.00	1.00
AdjDel/Veh:	88.4	39.4	59.1	52.4	45.7	45.7	62.6	48.7	89.2	92.3	41.1	41.3
LOS by Move:	F	D	E+	D-	D	D	E	D	F	F	D	D
HCM2kAvgQ:	17	12	19	19	32	32	6	14	26	14	11	12

Note: Queue reported is the number of cars per lane.

Hamptons Apartment Complex TIA
 SJ15-1612
 Background PM

Level Of Service Computation Report
 2000 HCM Operations (Future Volume Alternative)
 Background PM

Intersection #13: Tantau Avenue / Homestead Road

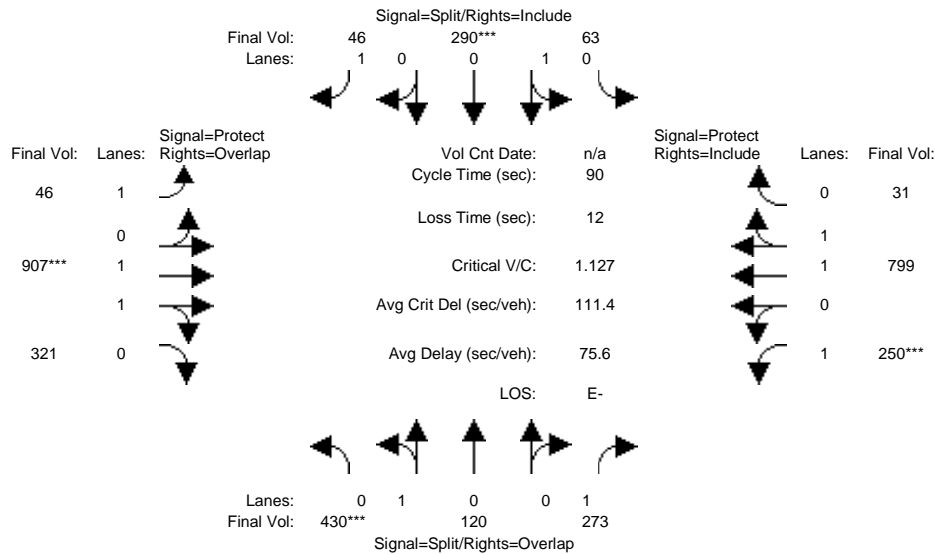

Street Name:	Tantau Avenue						Homestead Road					
Approach:	North Bound			South Bound			East Bound			West Bound		
Movement:	L	T	R	L	T	R	L	T	R	L	T	R
Min. Green:	7	10	10	7	10	10	7	10	10	7	10	10
Y+R:	4.0	4.0	4.0	4.0	4.0	4.0	4.0	4.0	4.0	4.0	4.0	4.0

Volume Module:												
Base Vol:	200	86	145	60	268	40	36	779	214	232	731	29
Growth Adj:	1.00	1.00	1.00	1.00	1.00	1.00	1.00	1.00	1.00	1.00	1.00	1.00
Initial Bse:	200	86	145	60	268	40	36	779	214	232	731	29
Added Vol:	0	0	0	0	0	0	0	0	0	0	0	0
PasserByVol:	230	34	128	3	22	6	10	128	107	18	68	2
Initial Fut:	430	120	273	63	290	46	46	907	321	250	799	31
User Adj:	1.00	1.00	1.00	1.00	1.00	1.00	1.00	1.00	1.00	1.00	1.00	1.00
PHF Adj:	1.00	1.00	1.00	1.00	1.00	1.00	1.00	1.00	1.00	1.00	1.00	1.00
PHF Volume:	430	120	273	63	290	46	46	907	321	250	799	31
Reduct Vol:	0	0	0	0	0	0	0	0	0	0	0	0
Reduced Vol:	430	120	273	63	290	46	46	907	321	250	799	31
PCE Adj:	1.00	1.00	1.00	1.00	1.00	1.00	1.00	1.00	1.00	1.00	1.00	1.00
MLF Adj:	1.00	1.00	1.00	1.00	1.00	1.00	1.00	1.00	1.00	1.00	1.00	1.00
Final Volume:	430	120	273	63	290	46	46	907	321	250	799	31

Saturation Flow Module:												
Sat/Lane:	1900	1900	1900	1900	1900	1900	1900	1900	1900	1900	1900	1900
Adjustment:	0.95	0.95	0.92	0.95	0.95	0.92	0.92	0.98	0.95	0.92	0.97	0.95
Lanes:	0.78	0.22	1.00	0.18	0.82	1.00	1.00	1.46	0.54	1.00	1.92	0.08
Final Sat.:	1407	393	1750	321	1479	1750	1750	2732	967	1750	3562	138

Capacity Analysis Module:												
Vol/Sat:	0.31	0.31	0.16	0.20	0.20	0.03	0.03	0.33	0.33	0.14	0.22	0.22
Crit Moves:	***			***			***			***		
Green Time:	24.4	24.4	35.8	15.7	15.7	15.7	9.8	26.5	50.9	11.4	28.2	28.2
Volume/Cap:	1.13	1.13	0.39	1.13	1.13	0.15	0.24	1.13	0.59	1.13	0.72	0.72
Delay/Veh:	113.1	113	19.7	126.7	127	31.8	37.4	101	13.1	138.0	29.6	29.6
User DelAdj:	1.00	1.00	1.00	1.00	1.00	1.00	1.00	1.00	1.00	1.00	1.00	1.00
AdjDel/Veh:	113.1	113	19.7	126.7	127	31.8	37.4	101	13.1	138.0	29.6	29.6
LOS by Move:	F	F	B-	F	F	C	D+	F	B	F	C	C
HCM2kAvgQ:	28	28	6	19	19	1	1	27	11	12	10	10

Note: Queue reported is the number of cars per lane.

Hamptons Apartment Complex TIA
 SJ15-1612
 Background PM

Level Of Service Computation Report
 2000 HCM Operations (Future Volume Alternative)
 Background PP PM

Intersection #13: Tantau Avenue / Homestead Road

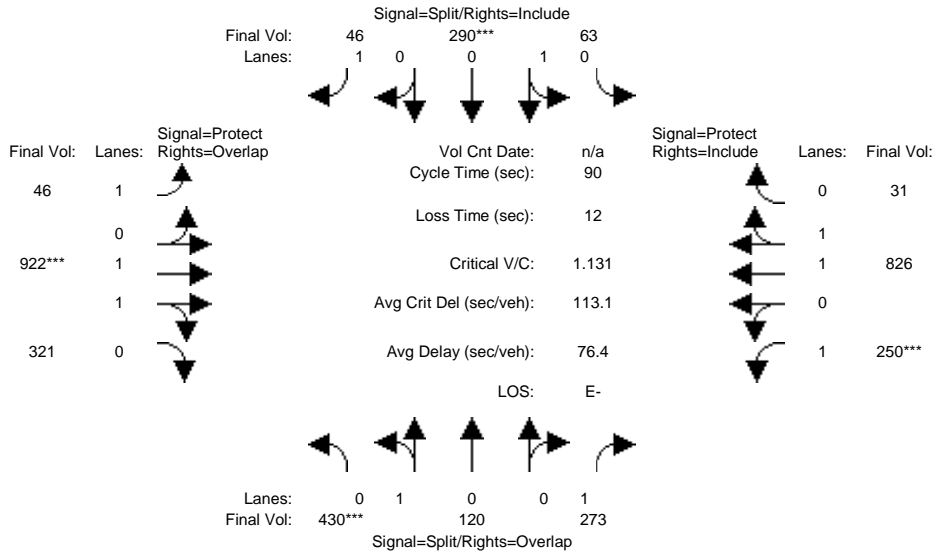

Street Name:	Tantau Avenue						Homestead Road					
	North Bound			South Bound			East Bound			West Bound		
Approach:												
Movement:	L	T	R	L	T	R	L	T	R	L	T	R
Min. Green:	7	10	10	7	10	10	7	10	10	7	10	10
Y+R:	4.0	4.0	4.0	4.0	4.0	4.0	4.0	4.0	4.0	4.0	4.0	4.0

Volume Module:												
Base Vol:	200	86	145	60	268	40	36	779	214	232	731	29
Growth Adj:	1.00	1.00	1.00	1.00	1.00	1.00	1.00	1.00	1.00	1.00	1.00	1.00
Initial Bse:	200	86	145	60	268	40	36	779	214	232	731	29
Added Vol:	0	0	0	0	0	0	0	15	0	0	27	0
PasserByVol:	230	34	128	3	22	6	10	128	107	18	68	2
Initial Fut:	430	120	273	63	290	46	46	922	321	250	826	31
User Adj:	1.00	1.00	1.00	1.00	1.00	1.00	1.00	1.00	1.00	1.00	1.00	1.00
PHF Adj:	1.00	1.00	1.00	1.00	1.00	1.00	1.00	1.00	1.00	1.00	1.00	1.00
PHF Volume:	430	120	273	63	290	46	46	922	321	250	826	31
Reduct Vol:	0	0	0	0	0	0	0	0	0	0	0	0
Reduced Vol:	430	120	273	63	290	46	46	922	321	250	826	31
PCE Adj:	1.00	1.00	1.00	1.00	1.00	1.00	1.00	1.00	1.00	1.00	1.00	1.00
MLF Adj:	1.00	1.00	1.00	1.00	1.00	1.00	1.00	1.00	1.00	1.00	1.00	1.00
Final Volume:	430	120	273	63	290	46	46	922	321	250	826	31

Saturation Flow Module:												
Sat/Lane:	1900	1900	1900	1900	1900	1900	1900	1900	1900	1900	1900	1900
Adjustment:	0.95	0.95	0.92	0.95	0.95	0.92	0.92	0.98	0.95	0.92	0.97	0.95
Lanes:	0.78	0.22	1.00	0.18	0.82	1.00	1.00	1.47	0.53	1.00	1.93	0.07
Final Sat.:	1407	393	1750	321	1479	1750	1750	2744	955	1750	3566	134

Capacity Analysis Module:												
Vol/Sat:	0.31	0.31	0.16	0.20	0.20	0.03	0.03	0.34	0.34	0.14	0.23	0.23
Crit Moves:	***				***			***			***	
Green Time:	24.3	24.3	35.7	15.6	15.6	15.6	9.6	26.7	51.0	11.4	28.5	28.5
Volume/Cap:	1.13	1.13	0.39	1.13	1.13	0.15	0.25	1.13	0.59	1.13	0.73	0.73
Delay/Veh:	114.9	115	19.8	128.5	129	31.8	37.6	103	13.2	139.8	29.7	29.7
User DelAdj:	1.00	1.00	1.00	1.00	1.00	1.00	1.00	1.00	1.00	1.00	1.00	1.00
AdjDel/Veh:	114.9	115	19.8	128.5	129	31.8	37.6	103	13.2	139.8	29.7	29.7
LOS by Move:	F	F	B-	F	F	C	D+	F	B	F	C	C
HCM2kAvgQ:	28	28	6	19	19	1	1	28	11	12	11	11

Note: Queue reported is the number of cars per lane.

Hamptons Apartment Complex TIA
 SJ15-1612
 Background PM

Level Of Service Computation Report
 2000 HCM Operations (Future Volume Alternative)
 Background PM

Intersection #14: Tantau Avenue / Vallco Parkway

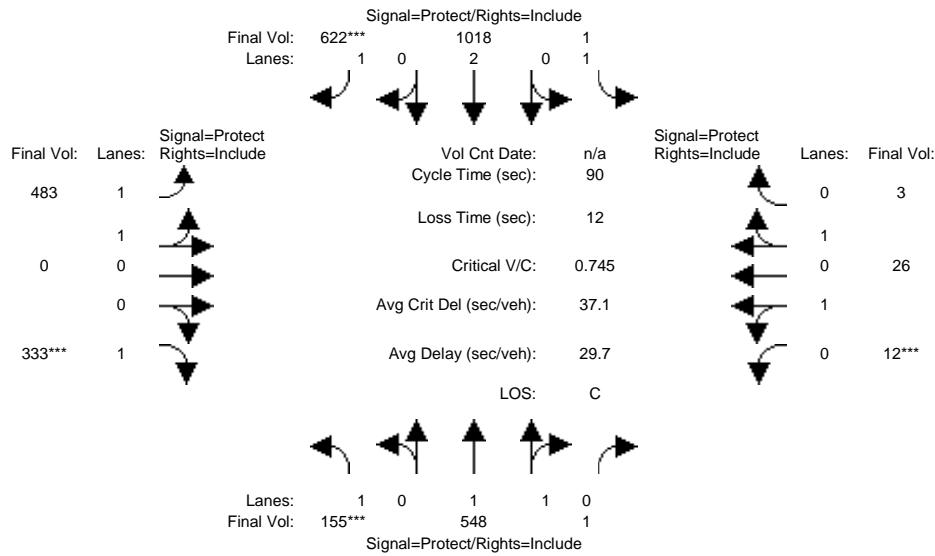

Street Name:	Tantau Avenue						Vallco Parkway					
	North Bound			South Bound			East Bound			West Bound		
Approach:	North Bound			South Bound			East Bound			West Bound		
Movement:	L	T	R	L	T	R	L	T	R	L	T	R
Min. Green:	7	10	10	7	10	10	7	10	10	7	10	10
Y+R:	4.0	4.0	4.0	4.0	4.0	4.0	4.0	4.0	4.0	4.0	4.0	4.0

Volume Module:												
Base Vol:	49	260	1	1	494	197	261	0	152	12	26	3
Growth Adj:	1.00	1.00	1.00	1.00	1.00	1.00	1.00	1.00	1.00	1.00	1.00	1.00
Initial Bse:	49	260	1	1	494	197	261	0	152	12	26	3
Added Vol:	0	0	0	0	0	0	0	0	0	0	0	0
PasserByVol:	106	288	0	0	524	425	222	0	181	0	0	0
Initial Fut:	155	548	1	1	1018	622	483	0	333	12	26	3
User Adj:	1.00	1.00	1.00	1.00	1.00	1.00	1.00	1.00	1.00	1.00	1.00	1.00
PHF Adj:	1.00	1.00	1.00	1.00	1.00	1.00	1.00	1.00	1.00	1.00	1.00	1.00
PHF Volume:	155	548	1	1	1018	622	483	0	333	12	26	3
Reduct Vol:	0	0	0	0	0	0	0	0	0	0	0	0
Reduced Vol:	155	548	1	1	1018	622	483	0	333	12	26	3
PCE Adj:	1.00	1.00	1.00	1.00	1.00	1.00	1.00	1.00	1.00	1.00	1.00	1.00
MLF Adj:	1.00	1.00	1.00	1.00	1.00	1.00	1.00	1.00	1.00	1.00	1.00	1.00
Final Volume:	155	548	1	1	1018	622	483	0	333	12	26	3

Saturation Flow Module:												
Sat/Lane:	1900	1900	1900	1900	1900	1900	1900	1900	1900	1900	1900	1900
Adjustment:	0.92	0.97	0.95	0.92	1.00	0.92	0.93	1.00	0.92	0.95	0.95	0.95
Lanes:	1.00	1.99	0.01	1.00	2.00	1.00	2.00	0.00	1.00	0.58	1.27	0.15
Final Sat.:	1750	3693	7	1750	3800	1750	3550	0	1750	1054	2283	263

Capacity Analysis Module:												
Vol/Sat:	0.09	0.15	0.15	0.00	0.27	0.36	0.14	0.00	0.19	0.01	0.01	0.01
Crit Moves:	***					****			****	****	****	
Green Time:	9.9	32.6	32.6	17.1	39.8	39.8	15.6	0.0	21.3	7.0	12.7	12.7
Volume/Cap:	0.80	0.41	0.41	0.00	0.61	0.80	0.79	0.00	0.80	0.15	0.08	0.08
Delay/Veh:	60.3	21.7	21.7	29.6	19.8	27.9	42.3	0.0	43.3	39.0	33.6	33.6
User DelAdj:	1.00	1.00	1.00	1.00	1.00	1.00	1.00	1.00	1.00	1.00	1.00	1.00
AdjDel/Veh:	60.3	21.7	21.7	29.6	19.8	27.9	42.3	0.0	43.3	39.0	33.6	33.6
LOS by Move:	E	C+	C+	C	B-	C	D	A	D	D+	C-	C-
HCM2kAvgQ:	4	5	5	0	11	18	7	0	10	1	1	1

Note: Queue reported is the number of cars per lane.

Hamptons Apartment Complex TIA
 SJ15-1612
 Background PM

Level Of Service Computation Report
 2000 HCM Operations (Future Volume Alternative)
 Background PP PM

Intersection #14: Tantau Avenue / Vallco Parkway

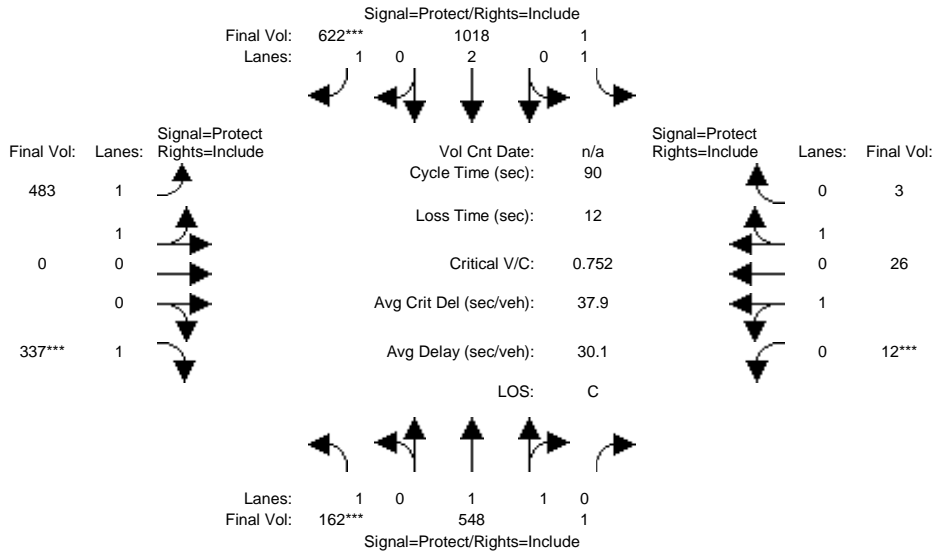

Street Name:	Tantau Avenue						Vallco Parkway					
	North Bound			South Bound			East Bound			West Bound		
Approach:												
Movement:	L	T	R	L	T	R	L	T	R	L	T	R
Min. Green:	7	10	10	7	10	10	7	10	10	7	10	10
Y+R:	4.0	4.0	4.0	4.0	4.0	4.0	4.0	4.0	4.0	4.0	4.0	4.0

Volume Module:												
Base Vol:	49	260	1	1	494	197	261	0	152	12	26	3
Growth Adj:	1.00	1.00	1.00	1.00	1.00	1.00	1.00	1.00	1.00	1.00	1.00	1.00
Initial Bse:	49	260	1	1	494	197	261	0	152	12	26	3
Added Vol:	7	0	0	0	0	0	0	0	4	0	0	0
PasserByVol:	106	288	0	0	524	425	222	0	181	0	0	0
Initial Fut:	162	548	1	1	1018	622	483	0	337	12	26	3
User Adj:	1.00	1.00	1.00	1.00	1.00	1.00	1.00	1.00	1.00	1.00	1.00	1.00
PHF Adj:	1.00	1.00	1.00	1.00	1.00	1.00	1.00	1.00	1.00	1.00	1.00	1.00
PHF Volume:	162	548	1	1	1018	622	483	0	337	12	26	3
Reduct Vol:	0	0	0	0	0	0	0	0	0	0	0	0
Reduced Vol:	162	548	1	1	1018	622	483	0	337	12	26	3
PCE Adj:	1.00	1.00	1.00	1.00	1.00	1.00	1.00	1.00	1.00	1.00	1.00	1.00
MLF Adj:	1.00	1.00	1.00	1.00	1.00	1.00	1.00	1.00	1.00	1.00	1.00	1.00
Final Volume:	162	548	1	1	1018	622	483	0	337	12	26	3

Saturation Flow Module:												
Sat/Lane:	1900	1900	1900	1900	1900	1900	1900	1900	1900	1900	1900	1900
Adjustment:	0.92	0.97	0.95	0.92	1.00	0.92	0.93	1.00	0.92	0.95	0.95	0.95
Lanes:	1.00	1.99	0.01	1.00	2.00	1.00	2.00	0.00	1.00	0.58	1.27	0.15
Final Sat.:	1750	3693	7	1750	3800	1750	3550	0	1750	1054	2283	263

Capacity Analysis Module:												
Vol/Sat:	0.09	0.15	0.15	0.00	0.27	0.36	0.14	0.00	0.19	0.01	0.01	0.01
Crit Moves:	***					****			****	****		
Green Time:	10.3	32.6	32.6	17.1	39.4	39.4	15.6	0.0	21.3	7.0	12.7	12.7
Volume/Cap:	0.81	0.41	0.41	0.00	0.61	0.81	0.78	0.00	0.81	0.15	0.08	0.08
Delay/Veh:	60.6	21.7	21.7	29.6	20.1	28.7	42.2	0.0	44.0	39.0	33.6	33.6
User DelAdj:	1.00	1.00	1.00	1.00	1.00	1.00	1.00	1.00	1.00	1.00	1.00	1.00
AdjDel/Veh:	60.6	21.7	21.7	29.6	20.1	28.7	42.2	0.0	44.0	39.0	33.6	33.6
LOS by Move:	E	C+	C+	C	C+	C	D	A	D	D+	C-	C-
HCM2kAvgQ:	4	5	5	0	11	18	7	0	10	1	1	1

Note: Queue reported is the number of cars per lane.

Hamptons Apartment Complex TIA
SJ15-1612
Background PM

Level Of Service Computation Report
2000 HCM Operations (Future Volume Alternative)
Background PM

Intersection #15: Tantau Avenue / Stevens Creek Boulevard

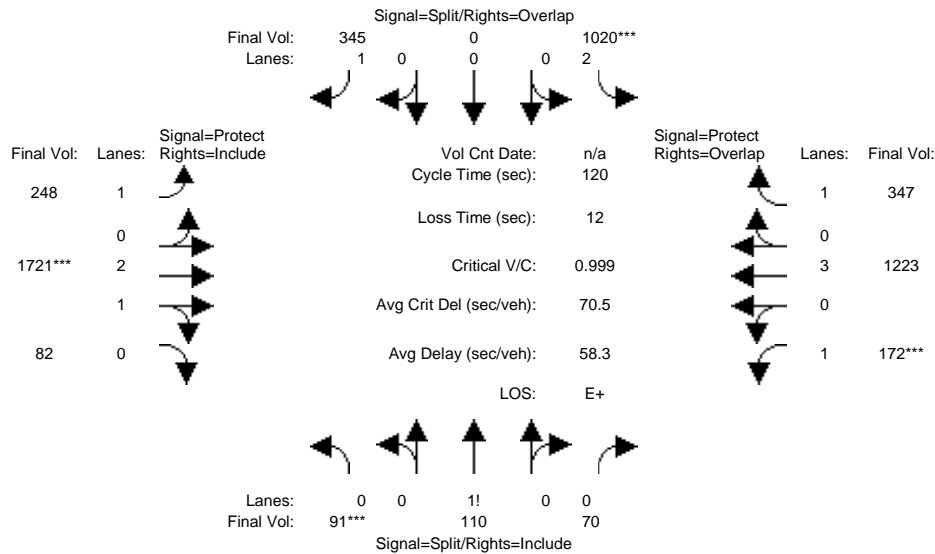

Street Name:	Tantau Avenue						Stevens Creek Boulevard					
	North Bound			South Bound			East Bound			West Bound		
Approach:												
Movement:	L	T	R	L	T	R	L	T	R	L	T	R
Min. Green:	7	10	10	7	10	10	7	10	10	7	10	10
Y+R:	4.0	4.0	4.0	4.0	4.0	4.0	4.0	4.0	4.0	4.0	4.0	4.0

Volume Module:												
Base Vol:	82	91	69	435	0	223	126	1343	63	165	731	93
Growth Adj:	1.00	1.00	1.00	1.00	1.00	1.00	1.00	1.00	1.00	1.00	1.00	1.00
Initial Bse:	82	91	69	435	0	223	126	1343	63	165	731	93
Added Vol:	0	0	0	0	0	0	0	0	0	0	0	0
PasserByVol:	9	19	1	585	0	122	122	378	19	7	492	254
Initial Fut:	91	110	70	1020	0	345	248	1721	82	172	1223	347
User Adj:	1.00	1.00	1.00	1.00	1.00	1.00	1.00	1.00	1.00	1.00	1.00	1.00
PHF Adj:	1.00	1.00	1.00	1.00	1.00	1.00	1.00	1.00	1.00	1.00	1.00	1.00
PHF Volume:	91	110	70	1020	0	345	248	1721	82	172	1223	347
Reduct Vol:	0	0	0	0	0	0	0	0	0	0	0	0
Reduced Vol:	91	110	70	1020	0	345	248	1721	82	172	1223	347
PCE Adj:	1.00	1.00	1.00	1.00	1.00	1.00	1.00	1.00	1.00	1.00	1.00	1.00
MLF Adj:	1.00	1.00	1.00	1.00	1.00	1.00	1.00	1.00	1.00	1.00	1.00	1.00
Final Volume:	91	110	70	1020	0	345	248	1721	82	172	1223	347

Saturation Flow Module:												
Sat/Lane:	1900	1900	1900	1900	1900	1900	1900	1900	1900	1900	1900	1900
Adjustment:	0.92	0.92	0.92	0.83	1.00	0.92	0.92	0.98	0.95	0.92	1.00	0.92
Lanes:	0.33	0.41	0.26	2.00	0.00	1.00	1.00	2.86	0.14	1.00	3.00	1.00
Final Sat.:	588	710	452	3150	0	1750	1750	5345	255	1750	5700	1750

Capacity Analysis Module:												
Vol/Sat:	0.15	0.15	0.15	0.32	0.00	0.20	0.14	0.32	0.32	0.10	0.21	0.20
Crit Moves:	***			****			****			****		
Green Time:	18.6	18.6	18.6	38.9	0.0	59.0	20.1	38.7	38.7	11.8	30.4	69.3
Volume/Cap:	1.00	1.00	1.00	1.00	0.00	0.40	0.85	1.00	1.00	1.00	0.85	0.34
Delay/Veh:	105.0	105	105.0	68.4	0.0	19.6	68.4	61.5	61.5	122.3	47.4	13.6
User DelAdj:	1.00	1.00	1.00	1.00	1.00	1.00	1.00	1.00	1.00	1.00	1.00	1.00
AdjDel/Veh:	105.0	105	105.0	68.4	0.0	19.6	68.4	61.5	61.5	122.3	47.4	13.6
LOS by Move:	F	F	F	E	A	B-	E	E	E	F	D	B
HCM2kAvgQ:	16	16	16	26	0	8	10	25	25	11	17	7

Note: Queue reported is the number of cars per lane.

Hamptons Apartment Complex TIA
 SJ15-1612
 Background PM

Level Of Service Computation Report
 2000 HCM Operations (Future Volume Alternative)
 Background PP PM

Intersection #15: Tantau Avenue / Stevens Creek Boulevard

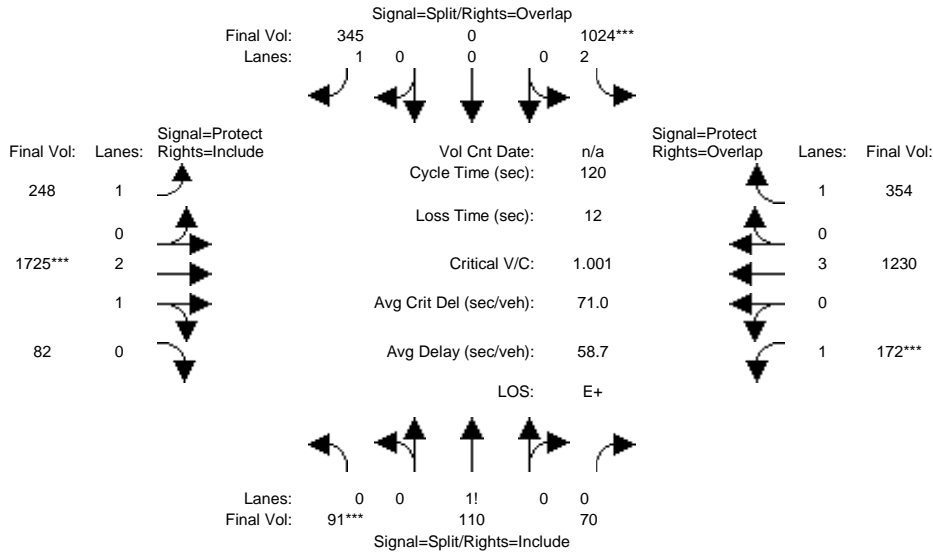

Street Name:	Tantau Avenue						Stevens Creek Boulevard					
	North Bound			South Bound			East Bound			West Bound		
Approach:												
Movement:	L	T	R	L	T	R	L	T	R	L	T	R
Min. Green:	7	10	10	7	10	10	7	10	10	7	10	10
Y+R:	4.0	4.0	4.0	4.0	4.0	4.0	4.0	4.0	4.0	4.0	4.0	4.0

Volume Module:												
Base Vol:	82	91	69	435	0	223	126	1343	63	165	731	93
Growth Adj:	1.00	1.00	1.00	1.00	1.00	1.00	1.00	1.00	1.00	1.00	1.00	1.00
Initial Bse:	82	91	69	435	0	223	126	1343	63	165	731	93
Added Vol:	0	0	0	4	0	0	0	4	0	0	7	7
PasserByVol:	9	19	1	585	0	122	122	378	19	7	492	254
Initial Fut:	91	110	70	1024	0	345	248	1725	82	172	1230	354
User Adj:	1.00	1.00	1.00	1.00	1.00	1.00	1.00	1.00	1.00	1.00	1.00	1.00
PHF Adj:	1.00	1.00	1.00	1.00	1.00	1.00	1.00	1.00	1.00	1.00	1.00	1.00
PHF Volume:	91	110	70	1024	0	345	248	1725	82	172	1230	354
Reduct Vol:	0	0	0	0	0	0	0	0	0	0	0	0
Reduced Vol:	91	110	70	1024	0	345	248	1725	82	172	1230	354
PCE Adj:	1.00	1.00	1.00	1.00	1.00	1.00	1.00	1.00	1.00	1.00	1.00	1.00
MLF Adj:	1.00	1.00	1.00	1.00	1.00	1.00	1.00	1.00	1.00	1.00	1.00	1.00
Final Volume:	91	110	70	1024	0	345	248	1725	82	172	1230	354

Saturation Flow Module:												
Sat/Lane:	1900	1900	1900	1900	1900	1900	1900	1900	1900	1900	1900	1900
Adjustment:	0.92	0.92	0.92	0.83	1.00	0.92	0.92	0.98	0.95	0.92	1.00	0.92
Lanes:	0.33	0.41	0.26	2.00	0.00	1.00	1.00	2.86	0.14	1.00	3.00	1.00
Final Sat.:	588	710	452	3150	0	1750	1750	5346	254	1750	5700	1750

Capacity Analysis Module:												
Vol/Sat:	0.15	0.15	0.15	0.33	0.00	0.20	0.14	0.32	0.32	0.10	0.22	0.20
Crit Moves:	***			***			***			***		
Green Time:	18.6	18.6	18.6	39.0	0.0	59.0	20.0	38.7	38.7	11.8	30.5	69.4
Volume/Cap:	1.00	1.00	1.00	1.00	0.00	0.40	0.85	1.00	1.00	1.00	0.85	0.35
Delay/Veh:	105.7	106	105.7	68.9	0.0	19.6	69.0	62.1	62.1	123.0	47.6	13.6
User DelAdj:	1.00	1.00	1.00	1.00	1.00	1.00	1.00	1.00	1.00	1.00	1.00	1.00
AdjDel/Veh:	105.7	106	105.7	68.9	0.0	19.6	69.0	62.1	62.1	123.0	47.6	13.6
LOS by Move:	F	F	F	E	A	B-	E	E	E	F	D	B
HCM2kAvgQ:	16	16	16	27	0	8	10	25	25	11	17	7

Note: Queue reported is the number of cars per lane.

Hamptons Apartment Complex TIA
SJ15-1612
Background PM

Level Of Service Computation Report
2000 HCM Operations (Future Volume Alternative)
Background PM

Intersection #16: Lawrence Expressway / Homestead Road

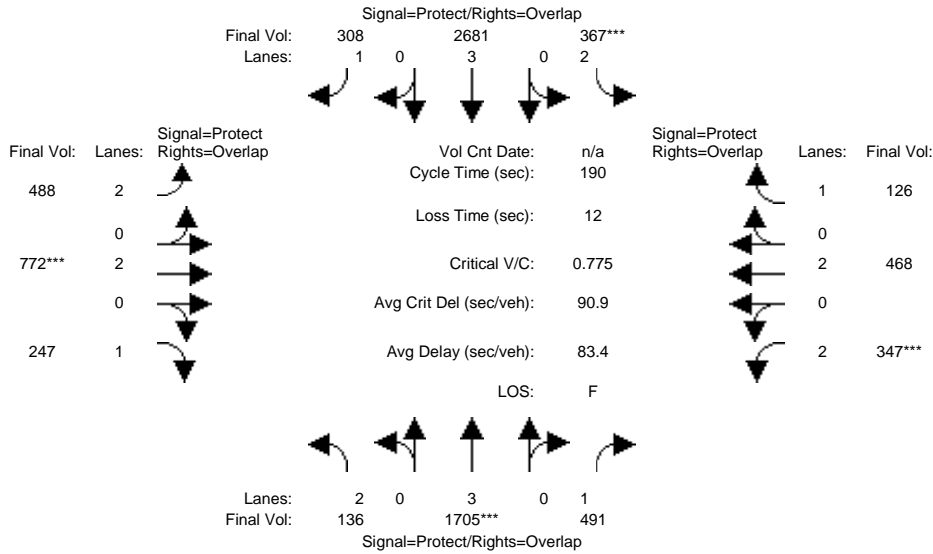

Street Name:	Lawrence Expressway						Homestead Road					
	North Bound			South Bound			East Bound			West Bound		
Approach:												
Movement:	L	T	R	L	T	R	L	T	R	L	T	R
Min. Green:	17	95	95	27	105	105	27	38	38	30	41	41
Y+R:	4.0	4.0	4.0	4.0	4.0	4.0	4.0	4.0	4.0	4.0	4.0	4.0

Volume Module:												
Base Vol:	133	1842	425	307	2980	277	398	648	198	323	405	86
Growth Adj:	1.00	1.00	1.00	1.00	1.00	1.00	1.00	1.00	1.00	1.00	1.00	1.00
Initial Bse:	133	1842	425	307	2980	277	398	648	198	323	405	86
Added Vol:	0	0	0	0	0	0	0	0	0	0	0	0
PasserByVol:	3	316	66	60	414	31	90	124	49	24	63	40
Initial Fut:	136	2158	491	367	3394	308	488	772	247	347	468	126
User Adj:	1.00	0.79	1.00	1.00	0.79	1.00	1.00	1.00	1.00	1.00	1.00	1.00
PHF Adj:	1.00	1.00	1.00	1.00	1.00	1.00	1.00	1.00	1.00	1.00	1.00	1.00
PHF Volume:	136	1705	491	367	2681	308	488	772	247	347	468	126
Reduct Vol:	0	0	0	0	0	0	0	0	0	0	0	0
Reduced Vol:	136	1705	491	367	2681	308	488	772	247	347	468	126
PCE Adj:	1.00	1.00	1.00	1.00	1.00	1.00	1.00	1.00	1.00	1.00	1.00	1.00
MLF Adj:	1.00	1.00	1.00	1.00	1.00	1.00	1.00	1.00	1.00	1.00	1.00	1.00
Final Volume:	136	1705	491	367	2681	308	488	772	247	347	468	126

Saturation Flow Module:												
Sat/Lane:	1900	1900	1900	1900	1900	1900	1900	1900	1900	1900	1900	1900
Adjustment:	0.83	1.00	0.92	0.83	1.00	0.92	0.83	1.00	0.92	0.83	1.00	0.92
Lanes:	2.00	3.00	1.00	2.00	3.00	1.00	2.00	2.00	1.00	2.00	2.00	1.00
Final Sat.:	3150	5700	1750	3150	5700	1750	3150	3800	1750	3150	3800	1750

Capacity Analysis Module:												
Vol/Sat:	0.04	0.30	0.28	0.12	0.47	0.18	0.15	0.20	0.14	0.11	0.12	0.07
Crit Moves:	****			****			****			****		
Green Time:	16.0	89.4	117.6	25.4	98.8	126.4	27.7	35.7	51.7	28.2	36.3	61.7
Volume/Cap:	0.51	0.64	0.45	0.87	0.90	0.26	1.06	1.08	0.52	0.74	0.65	0.22
Delay/Veh:	95.7	64.9	42.8	112.3	80.2	32.0	146.1	139	63.3	88.6	77.4	49.8
User DelAdj:	1.00	1.00	1.00	1.00	1.00	1.00	1.00	1.00	1.00	1.00	1.00	1.00
AdjDel/Veh:	95.7	64.9	42.8	112.3	80.2	32.0	146.1	139	63.3	88.6	77.4	49.8
LOS by Move:	F	E	D	F	F	C-	F	F	E	F	E-	D
HCM2kAvgQ:	5	32	27	16	55	16	19	26	13	14	14	6

Note: Queue reported is the number of cars per lane.

Hamptons Apartment Complex TIA
SJ15-1612
Background PM

Level Of Service Computation Report
2000 HCM Operations (Future Volume Alternative)
Background PP PM

Intersection #16: Lawrence Expressway / Homestead Road

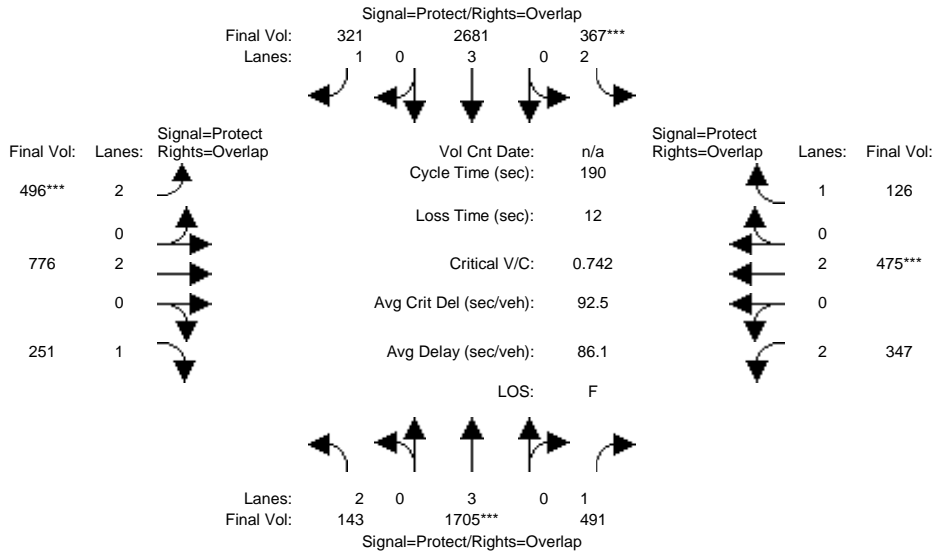

Street Name:	Lawrence Expressway						Homestead Road					
	North Bound			South Bound			East Bound			West Bound		
Approach:	North Bound			South Bound			East Bound			West Bound		
Movement:	L	T	R	L	T	R	L	T	R	L	T	R
Min. Green:	17	95	95	27	105	105	27	38	38	30	41	41
Y+R:	4.0	4.0	4.0	4.0	4.0	4.0	4.0	4.0	4.0	4.0	4.0	4.0

Volume Module:												
Base Vol:	133	1842	425	307	2980	277	398	648	198	323	405	86
Growth Adj:	1.00	1.00	1.00	1.00	1.00	1.00	1.00	1.00	1.00	1.00	1.00	1.00
Initial Bse:	133	1842	425	307	2980	277	398	648	198	323	405	86
Added Vol:	7	0	0	0	0	13	8	4	4	0	7	0
PasserByVol:	3	316	66	60	414	31	90	124	49	24	63	40
Initial Fut:	143	2158	491	367	3394	321	496	776	251	347	475	126
User Adj:	1.00	0.79	1.00	1.00	0.79	1.00	1.00	1.00	1.00	1.00	1.00	1.00
PHF Adj:	1.00	1.00	1.00	1.00	1.00	1.00	1.00	1.00	1.00	1.00	1.00	1.00
PHF Volume:	143	1705	491	367	2681	321	496	776	251	347	475	126
Reduct Vol:	0	0	0	0	0	0	0	0	0	0	0	0
Reduced Vol:	143	1705	491	367	2681	321	496	776	251	347	475	126
PCE Adj:	1.00	1.00	1.00	1.00	1.00	1.00	1.00	1.00	1.00	1.00	1.00	1.00
MLF Adj:	1.00	1.00	1.00	1.00	1.00	1.00	1.00	1.00	1.00	1.00	1.00	1.00
Final Volume:	143	1705	491	367	2681	321	496	776	251	347	475	126

Saturation Flow Module:												
Sat/Lane:	1900	1900	1900	1900	1900	1900	1900	1900	1900	1900	1900	1900
Adjustment:	0.83	1.00	0.92	0.83	1.00	0.92	0.83	1.00	0.92	0.83	1.00	0.92
Lanes:	2.00	3.00	1.00	2.00	3.00	1.00	2.00	2.00	1.00	2.00	2.00	1.00
Final Sat.:	3150	5700	1750	3150	5700	1750	3150	3800	1750	3150	3800	1750

Capacity Analysis Module:												
Vol/Sat:	0.05	0.30	0.28	0.12	0.47	0.18	0.16	0.20	0.14	0.11	0.13	0.07
Crit Moves:	****			****			****			****		
Green Time:	16.0	89.4	117.6	25.4	98.8	124.2	25.4	35.7	51.7	28.2	38.6	64.0
Volume/Cap:	0.54	0.64	0.45	0.87	0.90	0.28	1.18	1.09	0.53	0.74	0.62	0.21
Delay/Veh:	96.4	64.9	42.8	112.3	80.2	33.7	189.8	141	63.5	88.6	74.8	48.1
User DelAdj:	1.00	1.00	1.00	1.00	1.00	1.00	1.00	1.00	1.00	1.00	1.00	1.00
AdjDel/Veh:	96.4	64.9	42.8	112.3	80.2	33.7	189.8	141	63.5	88.6	74.8	48.1
LOS by Move:	F	E	D	F	F	C-	F	F	E	F	E	D
HCM2kAvgQ:	6	32	27	16	55	17	23	26	13	14	14	6

Note: Queue reported is the number of cars per lane.

APPENDIX C: APPROVED, NOT OCCUPIED, AND PENDING PROJECTS



TIA Land Use Data 03/31/2015

TIA Information based on Major Development Update

Project Type	Planning Permit File No.	Address	Cross Street	Description	Existing SF/Units	Existing Land Use	Proposed SF/Units	Proposed Use(s)	Planning Permit Status	Project Status/Planning Notes
Commercial	2014-7733	1010 Sunnysvale Saratoga Rd.	1010 Sunnysvale-Saratoga Rd.	Special Development Permit for a new 14,578 sq. ft. pharmacy with a drive thru (Rite Aide).	N/A	Vacant	14,578 s.f.	Retail (Rite-Aide pharmacy with a drive-thru)	Pending Review	Also see expired SDP 2007-0306
Commercial	2014-7990	1500 Partridge Ave	Dunford Wy	Use Permit to allow the reuse of buildings for a primary school at a former Raynor activity Center.		Vacant		School 520 students (K-5)	Pending Review	Deemed incomplete at PRC 11/24/14, EIR scoping in process
Commercial	2014-7618	250 E Java	Geneva Dr.	Preliminary Review for a new 6-story hotel with 168 rooms and 3,000 sf of ground floor retail.	19,874 s.f.	Shopping center	168 Room 3000 s.f.	Hotel Retail	Comments Provided (PR)	Preliminary Review comments provided 7/28/14. Formal application to follow.
Commercial	2014-7659	590 W. El Camino Real	S. Mathilda	Special Development Permit for an 83-Room Hotel	2,000 s.f.	Auto Repair	83 Room	Hotel	Pending Review	PRC Comments Provided, application not complete
Commercial	2013-7608	696 N Mathilda Ave	San Aleso	Combine two parcels, demolish existing structures and construct a 4,387 sq. ft. restaurant with drive thru.	1,650 s.f. 9,800 s.f.	Auto Repair Vacant blg.	4,387 s.f.	Restaurant with drive-thru	Pending Review	Project application pending
Commercial	2015-7107	725 S. Fair Oaks	E. El Camino Real	187 room, 5-story hotel	7782	Restuarant	187 5-story	Hotel rooms	Pending Review	Preliminary Review comments provided 2/25/15
Commercial	2014-8019	750 Lakeway Drive	Lakeside Drive	Redevelopment of a 232 room hotel with a partial demolition of 32 rooms and construction of a new 7-story hotel with 111 guest rooms (79 net new rooms) including 32 structured parking spaces and associated site modifications.	232 Room	Hotel	311 Room	Hotel	Pending Review	PRC completed. Awaiting formal submittal.
Commercial	2014-7633	861 E. El Camino Real	Wolfe	To allow a 166-room hotel (Hampton Inn)	31,784 s.f. (demo)	Retail	166 Room	Hotel	Pending Review	Project deemed incomplete 8/11/14. TIA is complete.
Industrial	2015-7157	1184 Mathilda Ave	Hwy 237	Preliminary Review of a new 230,535 sq. ft. office building on a surface parking lot within an existing campus.			230,535 s.f.	Office	Comments Provided (PR)	
Industrial	2011-7759	1240 Crossman	E. Java	Expansion of the NetApp campus (site 2) utilizing the green building bonus to enable 75.8% FAR for a total of 525,057 s.f. two 4-story buildings (12 and 14) and a 4-level parking garage would be built. Two buildings (10 & 11) to remain.	309,906 sq. ft.	Office	525,057 s.ft.	Office	Pending Review	On hold.
Industrial	2014-7584	215 Moffett Park Drive	Borregas	Major Moffett Park Design Review to allow a new 86,400 square foot R&D building, 5,000 sq. ft. restaurant, and 3-level parking garage resulting in resulting in total of 248,460 square feet of building area on the site and 59.9% FAR with LEED Gold Incentive.	157,060 sq. ft.	Office R&D	248,460 s.f. 5,000 s.f.	Office R&D Restaurant	Pending Review	Rev 1 Comments provided; Rev 2 Comments on 8/25/14. TIA in progress.
Industrial	2015-7027	221 N. Mathilda Ave.	W. California Ave.	Preliminary Review for a new 3-story office building (128,224 sf) and a 4-story parking structure at the Mellow's Nursery site.	Mellow's Nursery	Agricultural	128,224 s.f.	Office 4-story parking	Comments Provided (PR)	Preliminary Review comments provided 1/26/15
Industrial	2015-7101	520 Alamanor Ave.	N. Mathilda Ave.	New 4-story, 192,000 s.f. office building, 4,000 s.f. retail, and parking structure resulting in 100% FAR.	80,000	Industrial	192,000 s.f. 4,000 s.f.	Office building Retail	Comments Provided (PR)	PRC Comments provided 2/25/15
Industrial	2013-7609	615 N Mathilda Ave	Del Rey	Redevelop 8 parcels by combining the site into one site and construct two new 4-story R&D buildings for a total of 264,000 s.f. (80% FAR), and serviced by a new 5-level parking garage.	109,305 s.f.(eight lot total)	Light-industrial Restaurant w/drive-thru R&D	264,000 s.f.	Office R&D	Pending Review	Application Pending
Industrial	2013-7610	767 N Mathilda Ave	San Aleso	Revelop two existing parcels into one and construct one new 6-story 233,400 sf R&D office building resulting in a 110% FAR and serviced by a 4-level parking structure.	19,159 s.f. 6,250 s.f. 1177 s.f.	Night Club Restaurant Auto Repair	233,400 s.f.	Office R&D	Pending Review	Application Pending
Mixed Use	2015-7109	833 W El Camino Real	Hollenbeck Ave.	50 multi-family residential units, 5,000 s.f. of commercial, and a 53 room expansion of the Grand Hotel	24,858 s.f.	Commercial	50 5,000 s.f. 53	Multi-family res units Commercial Hotel rooms (expansion of Grand Hotel)	Pending Review	
Mixed Use	2014-7373 (Previous 2013-7528 & 2014-7093)	871 E Fremont Ave	E El Camino Real	Rezone to R-4/ECR, Special Development Permit and Vesting Tentative Map allow the redevelopment of Butcher's Corner site with 153 residential units (39 townhomes ad 114 flats) plus 6,936 square feet of retail/office use with surface and underground parking. Project includes preparation of an Environmental Impact Report (EIR) and annexation.	2	Single-family homes	39 townhomes 114 flats/apartments 6,936 retail/office	Townhomes Flats/Apartments Retail/Office	Comments Provided (PR)	Deemed incomplete.
Residential	2015-7108	1130 Prunelle Ct.	Hollenbeck Ave.	4-lot subdivision and development of 4 single-family homes including rezoning and environmental review. Special Development Permit and Vesting Tentative Map for the construction of 20 three-story townhome-style condominiums.	1	Single-family home	4	Single-family homes	Pending Review	
Residential	2014-7900	625 E Taylor	N. Fair Oaks		5400 s.f.	Commercial/Industrial	20	Townhomes	Comments Provided (PR)	PRC Comments provided 10/27/14 Comments provided on 2nd submittal 2/18/15 Outreach meeting held 2/19/15

Residential	2014-7602	688 Morse Ave	E. Ferndale Ave.	Special Development Permit application to create a 3-unit townhouse development; includes proposal to rezone to Planned Development (PD) and Vesting Tentative Map to subdivide 1 existing lot into 3 ownership lots and 1 common lot.	1	Single-family home	3	Townhomes	Pending Review	Incomplete
Residential	2015-7104	755 E. Evelyn Ave	Wolfe Rd.	42 unit (3-story) townhouse development	22155 s.f.	Industrial	42	Townhomes	Pending Review	PRC 3/02/15
Residential	2014-7417	915 De Guigne	Duane	Special Development Permit, Tentative Map and Environmental Review for a townhouse development with 450 units and demolition of the existing manufacturing site. Also see GPA and RZ under 2014-7416	261,726 s.f.	Industrial	450	Condos/Townhomes	Pending Review	Project and EIR under review. No public hearings scheduled at this time

Cupertino Approved and Pending Project Trip Generation													
Development	Occupied	Land Use	Size	Weekday		A.M. Peak Hour			P.M. Peak Hour				
				Rate	Trips	Rate	In	Out	Total	Rate	In	Out	Total
APPROVED													
1. Nineteen800 (formerly Rosebowl) (19800 Vallco Parkway) (1)	No	Residential	204 d.u.	-	-	-	11	54	65	-	55	27	82
	No	Retail	47,208 s.f.										
		Total											
3. Main Street Cupertino (West of Tantau, b/w Stevens Creek Blvd and Vallco Pkwy)(3)	No	Hotel	180 rooms										
	No	Housing	120 d.u.										
	No	Retail	77,900 s.f.										
	No	Office	260,000 s.f.										
	No	Restaurant	52,600 s.f.										
		Total			11,972		492	190	682		564	692	1,256
4. Tantau Retail (10100 N. Tantau Avenue)	No	Retail	10,582 s.f.				35	38	73		30	23	53
5. Homestead Square Shopping Center (20572-20688 Homestead Road)	Yes	Pharmacy	18,203 s.f.										
	No	Shopping Cntr	125,435 s.f.										
	Yes	Supermarket	54,984 s.f.										
		Total	198,622 s.f.	-	2,484	-	37	26	63	-	130	131	261
6. Cupertino Village (Homestead/Wolfe, SW corner) (4)	No	Retail	24,455 s.f.		2,344		34	22	55		74	80	154
7. Biltmore Apts (SW Corner Stevens Creek & Blaney) (5)	Yes	Mixed Use/Apt	80 units										
	No	Restaurant	7,000 s.f.										
		Total			634		-1	31	30		29	5	34
8. Saich Way Station (20803 Stevens Creek Blvd) (7)	No	Retail	11,092 s.f.										
	No	Restaurant	4,558 s.f.										
		Total	15,650 s.f.		650		34	21	55		23	23	46
9. Apple Campus 2 (19111 Pruneridge Ave) (6)	No	Office	14,200 employees		35,106		2,890	384	3,274		796	2,303	3,099
10. Foothill Live/Work (10121 N. Foothill) (8)	No	Residential	6 d.u.										
	No	Workspaces	2,610 s.f.										
		Total			-522		-11	-14	-25		-22	-22	-44
11. Imperial Ave Mixed-Use (10049 Imperial Ave)	No	Medical Ofc	525 s.f.										
	No	Retail	1,000 s.f.										
12. Hyatt House Hotel (SE Corner I-280 & Wolfe Rd) (10)	No	Hotel	148 rooms										
	No	Restaurant	3,073 s.f.										
		Total		8.17	1,209	0.53	46	32	78	0.60	45	33	89
13. 7-Eleven Convenience Market Expansion/Remodel (21530 Stevens Creek Blvd)	No	Convenience Store	2,279 s.f.										
14. McClellan Rd Subdivision (20840 McClellan Rd)	No	Residential	2 units										

PENDING													
Parkside Trails (E/S Stevens Canyon Rd, 150 ft. south of Ricardo Rd) (9)	No	Residential	18 units	11.93	215	1.24	6	17	22	1.25	14	8	22
Foothill Apartments (10310 N. Foothill Blvd) (11)	No	Residential	15 units	6.65	100	0.51	2	6	8	0.62	6	3	9

Notes:

Trip generation average rates from ITE's *Trip Generation*, 7th Edition.

- (1) Peak hour trip generation provided by City of Cupertino.
- (3) Trip generation rates from Fehr & Peers, Memo (November 2011)
- (4) Trip generation rates Hexagon, TIA (October 2007)
- (5) Trip generation rates Hexagon, TIA (November 2011)
- (6) Trip generation rates Fehr & Peers Apple Campus 2 EIR (August 2012)

Trip generation average rates from ITE's *Trip Generation*, 8th Edition.

- (7) Trip generation rates Fehr & Peers Memo (November 2012)
- (8) Trip generation rates Fehr & Peers Memo (July 2013)
- (9) Trip generation rates Fehr & Peers Memo (June 2012)

Trip generation average rates from ITE's *Trip Generation*, 9th Edition.

- (10) Trip generation rates from Hexagon TIA (October 2014)
- (11) Trip generation rates from Hexagon Memo (April 2014)

Updated January 13, 2015

City of Santa Clara Approved and Pending Projects List for Traffic Impact Analysis

PLN File No.	Project Planner	Approval Date	Project	Location and APN	Description	Anticipated year built (for TIA purposes)	Existing Square footage	Current Zoning	Current GP	Proposed Entitlements (i.e. Rezoning/Variance/CUP/DA/Map etc.)	Environmental Review (i.e. EIR, MND)	Proposed Maximum Building Height	Proposed Maximum Building Coverage	Status of Project (i.e. ADEIR under review, PC scheduled for _____ etc.)
Approved Projects- Last updated 3-2-15														
Z.1576	Debby Fernandez (408) 615-2457		Intel SC-13	2250 Mission College Boulevard 104-39-021	100,000 sf of office land use	2-5 years	Existing industrial use 568,055	PD		Amend PD Zoning, Mt Neg Dec	MND	625'	42%	Approved
PLN2003-03744 (Rezone from "A" Agriculture to PD Planned Development for 110 units of SF) PLN2003-03745 (General Plan Amendment) PLN2003-03558 (Rezoning of Senior parcel to PD(R3-18D)) PLN2007-06295 (Tentative Subdivision Map creating 110+ parcels) PLN2007-06327 (Rezoning application from "A" Agriculture to "B" Public park)	Gloria Sciara (408) 615-2453 408-615-2453	Apr-09	Former BAREC site/ Summerhill and Charlies Housing	90 Winchester Boulevard 303-17-047	165 apartment units REMAINING TO BE BUILT-- 110 small lot single family homes ALL OCCUPIED; Street improvements DONE/Winchester between Stevens Creek and Forest Ave	SFD 100% constructed and occupied. All public improvements accepted by PV -- Senior project upcoming		PD		PD rezoning, GP amendment, DA, EIR	FEIR, RAW, MMRP	3-4 stories for Senior housing 2 1/2 stories for SF and TH		80% of single family Constructed /Senior housing yet to be constructed
PLN2004-04317	Yen Chen (408) 615-2455	7/12/2005	Hewlett-Packard/Agilent Technologies	5301 Stevens Creek at Lawrence 316-17-018	PD rezone, Development Agreement for redevelopment of existing industrial use to become 727,500 sf of office and research & development	10 years	30,633	PD		DA extension- payment of 300K for terms of DA--future campus redevelopment still pending				
PLN2007-06310	Jeff Schwik (408) 615-2456	5/22/2007 (time extension approval date)	3 Com/Cognac Great America	5402 Great American Parkway at Yorba Buena APN 216-31-075	Existing office use redeveloped to 278,000 sf of office/research & development	2-5 years	144,000	PD	Light Industrial	Extension of DA (2007); Previous approvals-GPA #40, Rezone from B to PD, DA	EIR	165'	47% approx	Approved
PLN2007-06433/PLN2010-08487/PLN2013-09743 (renewal of PD)	Debby Fernandez (408) 615-2457	4/21/2009; 9/24/13 Approved 2 year extension	2550 Mission College Boulevard Office Retail	2350 Mission College Boulevard 104-13-097, 098 & 099	300,000 sf of office in two buildings and a 6 story parking garage; 6,000 square feet of retail	1-3 years	Existing industrial use 235,523	PD	High Intensity Office/R&D	Approved Rezone from PD to PD, Tentative Parcel Map & Architectural Review	Certified EIR	6-stories	52% 1.5 FAR	Time Extension filed for 2 year extension PC 2/9/11 & CC 3/15/11
PLN2007-06715, CEQ2007-01051	Debby Fernandez (408) 615-2457	4/15/2008	Sobrato Office Development	4301, 4401 & 4551 Great America Parkway 104-42-009 & 020	Rezone from PD & PD[ML] to construct (2) 12-story office buildings totaling 718,000 sq.ft. & (1) four-story parking garage on a developed property w/ (2) 300,000 sq.ft. existing office buildings that are to remain	10 years	(2) 300,000 sq.ft. office buildings	PD	High Intensity Office/R&D	Rezone from PD[ML] to PD, Development Agreement, Tentative Map & Architectural Review	EIR	190'	N/A	Application on hold per applicant request
PLN2007-06802, PLN2008-06920, CEQ2008-01057	Gloria Sciara (408) 615-2453 408-615-2453	9/18/2009	Fairfield Development	900 Kiely Boulevard 290-26-022	766 housing units, 57 SFD, 68 row houses, 115 townhouses/ 52apartments-- Modification to current PD-MC approval allowing additional 27 apartment units		Demo 131,500 sq. ft medical offices			PD-MC rezoning, DA, EIR				demolition complete, on-site and internal streets and infrastructure backbone improvement nearly constructed
PLN2008-06858 thru 06860	Yen Chen (408) 615-2455	Re-approved July 2013 by CC	Augustine Bowers Industrial Campus / Equity Office	2820-2727 Augustine Drive (includes properties on Bowers Avenue & Scott Boulevard)	1,969,600 sf of office and up to 35,000 sf of retail	2-5 years	444,752 sq. ft office/5,290 sq. ft restaurant	PD	Office/ Research & Development	General Plan Amendment, Rezone ML to PD, Subdivision Map, Development Agreement	Certified EIR	244 feet subject to FAA Reg Part 77	45%	Approved
PLN2008-07176 thru 07180	Shaun Lacey	Approved Revised Project on 7/16/2013	NVIDIA	2600, 2900 San Tomas Expressway & 2400 Condensa Street	1,200,000 sf of office and high-tech lab buildings replacing approx. 690,000 sf of office space. Revised DA	Project not likely to be constructed	Existing 690,550 sf office/ industrial use	PD	Office/ Research & Development	Amendment to PD. Prior approval included General Plan Amendment, Rezone ML to PD, Parcel Map or Lot Line Adjustment, Development Agreement	Certified EIR	133'	39%	Approved
Mission College	Yen Chen (408) 615-2455	4/21/2009	Mission College Master Plan	Mission College Boulevard & Great America Parkway	427,000 sq. ft.	2-5 years	Demo of 235,000 sq. ft.			Existing college campus				
PLN2008-07218, PLN2008-07220, PLN2008-07221, CEQ2008-01068	Debby Fernandez (408) 615-2457	5/11/2010	Yahoo!	5010 Old Ironsides Drive 104-04-064, 065, 111, 112, 113, 142, 143, 150 & 151	Phased development of a 3,060,000 sq.ft. office/R&D campus consisting of 13 six-story buildings, three commons buildings, surface parking & two levels of below grade parking	20 years	10 low-rise office/industrial buildings totaling 675,150 sq.ft.	PD	High Intensity Office/R&D	Approved Rezone from ML to PD, Development Agreement, Vesting Tentative Parcel Map, Architectural Review	Certified EIR	13-stories	27% lot coverage 1.5 FAR	Buildings south of Democracy Way demolished Jan - Feb 2011
PLN2010-08051, CEQ2010-01098	Payal Bhagat (408) 615-2458	5/10/2011	Marriot Townplace Suites	2875 Lakeside Drive 216-30-056	Rezone from Commercial Park (CP) to Planned Development (PD) to facilitate the development of a 107 room extended stay hotel with at-grade podium parking	under construction	demolition of an existing 9,843 sq.ft. building	CP	Regional Commercial	Rezone from CP to PD	MND	67 (5 stories)	32%	Continued from PC March 2, 2011 to March 23, 2011 PC
PLN2011-08759	Payal Bhagat (408) 615-2458	5/22/2012	Menlo Equities Office Park	3333 Scott Boulevard	Lot Line Adjustment and Architectural Review to facilitate the development of 735,000 square foot (5 buildings) office space	under construction	n/a	ML	Low Intensity Office R&D	Lot Line Adjustment and Architectural Review	Focus EIR	69'	14%	Work in progress, environmental work has initiated.

City of Santa Clara Approved and Pending Projects List for Traffic Impact Analysis

PLN File No.	Project Planner	Approval Date	Project	Location and APN	Description	Anticipated year built (for TIA purposes)	Existing Square footage	Current Zoning	Current GP	Proposed Entitlements (i.e. Rezoning/Variance/CUPD.A./Map etc.)	Environmental Review (i.e. EIR, MND)	Proposed Maximum Building Height	Proposed Maximum Building Coverage	Status of Project (i.e. ADEIR under review, PC scheduled for _____, etc.)
PLN2011-08996	Debby Fernandez (408) 615-2457	Approved by CC on July 17, 2012	Mellon Bank /Perry Airellaga	5403 Stevens Creek	General Plan Amendment from Low Intensity Office R&D to High Intensity Office R&D. Rezone from CT to PD & Architectural Review to construct (2) 6 story office buildings totalling 375,000 sq.ft. & (1) parking structure w/1261 spaces (2 below & 4 above) & 38 surface parking spaces in conjunction w/ demo of existing one-story commercial building (IHOP Restaurant)	one building completed	under construction	CT	Regional Commercial	GPA, Rezone, AC approval	TBD			
PLN2012-09341	Debby Fernandez (408) 615-2457 w/ interns Greg Owen and Steve Le	Staff level approval signed off on 8/21/2012	Patrick Duran	4888 Patrick Henry	13,000 square foot addition to existing industrial office	2-3 years				Staff level Arch. Approval				
PLN2010-08087, CEQ2010-01109	Payal Bhagat (408) 615-2458	UP approved by PC on 9-26-12 w/AC referral for design	Calvary Southern Baptist Church	5137 Forbes Avenue 293-13-002	Use Permit Amendment to U-417 to allow Sunday School classrooms and a weekday day care in the existing church facility in conjunction with construction of a new 2-story building, 14,000+ sq.ft. and parking, landscaping improvements	1-5 years	Demolition of the existing 7,000 sq.ft. building	B	Very Low Density Residential	Use Permit Amendment to U-417 to allow Sunday School classrooms and a weekday day care in the existing church facility in conjunction with construction of a new 2-story building, 14,000+ sq.ft. and parking, landscaping improvements	MND	29'		Work in progress
PLN2011-08955	Debby Fernandez (408) 615-2457	submitted 12/1/2011. Approved by CC on Sept 25, 2012 recommended approval of revised project/ save Larder House and restore in vicinity- relocated with SC two other historic homes	Santa Clara University	1043 Alviso St. (Project Address) APN: 269-23-076, 038, 039, 040, 041, 042, 061, 044, 045, 046, 047, 034, 071, 066	Rezone properties from CT & B to PD to construct a 4-story parking garage and 3-story Art & Art History building in conjunction with removal/demo/relocation of (e) structures on the project site (CEQ2011-01129) including historically significant structures.	Garage completed Art building		CC, PD and B		Rezone to PD				PC Rec approval to modified project 8-29-12. Relocate Larder house nearby and save two CA cottages by relocating into City HLC review rec City rec alternative to relocate historic structures onsite
PLN2012-09064	Debby Fernandez (408) 615-2457	Approved by CC on 11/13/2012	Rezone and Redevelopment of site	5175 El Camino Real former Kar town site	New four-story 133 unit multi-family apartment building with associated parking, landscaping and site improvements	under construction	Existing commercial property involving the demolition of all existing on-site structures			Rezone from CT to PD & Architectural review	EIR			
PLN2012-09176	Payal Bhagat (408) 615-2458	Council approval on 11/20/12 (pending on AC issues)	8 Single family project (formerly 8 unit townhome condominium project)	3499 The Alameda 266-16-069	Rezoning to PD from ML to facilitate development of six single family homes	under construction	vacant site with a slab on it	ML	Santa Clara Station Area	ML to PD rezoning	initial Study and MND	27'	2 stories	Changes are being made to the product layout and site plan. Environmental work has not begun yet.
PLN2012-09360	Payal Bhagat (408) 615-2458	Approved by CC on 2-12-13	James Redford	4306 Filmore Street 104-11-92	Rezoning single family property to PD to allow lot split and building of second new SFD on smaller lots. (tentative parcel map application)					Rezoning to PD				following PC meeting of 8-11-12, project requires redesign to be compatible with the older homes adjacent
PLN2012-09486	Debby Fernandez	10/24/2012	SCU Steve Brodie	1079 Alviso	Rezoning of one parcel to allow Larder House relocation	2013	SFD		Low Density Residential	PD rezone	Cal Ex		2 stories	NA
PLN2012-09224	Debby Fernandez (408) 615-2457	5/23/2012 Approved by CC on 4-23-13	Sobrato	2200 Lawson Lane	Amend PD zoning (PLN2007-06379) and Development Agreement (PLN2008-06880) for approved office R&D campus to increase building sq.ft. of allowable office space from 516,000 to 613,800 sq.ft.	1-2 years for new permit- previously approved project under	Approved prior PD to 516K square feet	PD	High Intensity Office/R&D	Amendment to PD	Addendum to EIR SCH#2007042165 CEQ2012-01146	five stories		PC meeting scheduled for 11/26
PLN2011-08990	Debby Fernandez (408) 615-2457	Approved by City Council and EIR adoption on March 28, 2013	Byer Properties	2000 El Camino Real	(Old Mervyn's Plaza @ Scott and El Camino Real) Architectural review of shopping center remodel and build new Target anchor store w/ demo of previous Mervyn's retail building (CEQ2011-01128 Initial Study)	90% complete and Target now open as of 10/8/14	Gross floor area of 283,917 square feet and result in a net increase of 11,346 square feet (4.2%) over existing conditions.	CC	Regional Mixed Use	Architectural Approval and CEQA review/approval	ISMND possible TIA	35 feet		EIR still pending; Arch design upgrade for western side of property and buildings approved for facade remodel
PLN2012-09162	Debby Fernandez (408) 615-2457	4/12/2012 Approved by City Council 3-26-13	Office Building	3000 Bowers	New (2) 5-story 150,000 sq.ft. office buildings, (1) 2-story 17,400 sq.ft. amenity building, and 6 story parking structure with a total of 1,200 parking spaces in conjunction with demolition of an existing 100,042 sq.ft. 2-story office building	2 years	102,600	ML	High Intensity Office/R&D	Architectural Review	TBD	75 feet		Under review by staff
PLN2012-09203	Payal Bhagat (408) 615-2458	APPROVED BY CC ON 4-8-13	DATA CENTER	2805 and 2807 Mission College Boulevard	Rezoning (PD Amendment) to allow a free standing data center and office space	1 YEAR			MEDIUM Density R and D	Rezone				

City of Santa Clara Approved and Pending Projects List for Traffic Impact Analysis

PLN File No.	Project Planner	Approval Date	Project	Location and APN	Description	Anticipated year built (for TIA purposes)	Existing Square footage	Current Zoning	Current GP	Proposed Entitlements (i.e. Rezoning/Variance/CUP/D.A./Map etc.)	Environmental Review (i.e. EIR, MND)	Proposed Maximum Building Height	Proposed Maximum Building Coverage	Status of Project (i.e. ADEIR under review, PC scheduled for _____ etc.)
PLN2013-09805	Payal Bhagat (408) 615-2458	Submitted 4/26/2013 Approved by CC 8/27/2013	Silicon Valley Builders	2585 ECR	GPA #76 from Community Mixed Use to High Density Residential & Rezone from CT to PD to construct a four-story 222 unit multi-family residential development with wrap parking structure w/ 375 on-site parking spaces in conjunction w/ demo of (e) commercial building (CEQ2013-01157)	1-2 years	former Wheels and Deals site - parking lot and temp buildings	CT	Community Mixed Use	GPA, rezone, CEQA	TBD			
PLN2012-09148	Shaun Lacey	8/14/2012-CC pending approval with architectural changes; CC approval of revised	Silicon Valley Builders	555 Saratoga Avenue 269-39-101	3-story condominium project with 13 units	2 years	gas station turned into service station	CN	Community Mixed Use	Rezoning to PD	MND likely	4 stories	approx 70%	TBD
PLN2013-09721	Yen Chen	3/5/13 PCC 3/19/13	Brad Kroutkup	4800 GAP	New 171,000 sq. ft. office building and new site improvements and two level parking garage	2013-14	71K	ML	Industrial	Architectural Review	possible MND			
PLN2012-09352	Payal Bhagat (408) 615-2458	1/8/2013	Silicon Valley Builders	2585 ECR	Rezoning to allow development of mixed use project 57 condos and retail 3,300 SQ. FT	under construction		MND	CT	Community Mixed Use	Rezoning to PD, Subdivision Map			TBD
PLN2012-09203	Payal Bhagat (408) 615-2458	5/10/2012 CC approval 4-9-13	SVP	2905 and 2907 Mission College Boulevard APNs: 104-16-118 and 104-16-119	data center retrofit in existing office building	1-2 years	office building-72,000 sq. ft.			Rezoning to PD to allow free-standing data center				
PLN2013-09744,09752,09753,09754	Yen Chen (408) 615-2455/Greg Owan	3/26/2013; Circ of MND Sept 15 2013	Elaine Breeze/Urban Planning Group	2635, 2645, 2611, 2621, 2655 El Camino Real (project will be referred to as 2645 ECR)	Application to allow development of a multi-family residential project (183 units) on 5 parcels including former Russels Furniture property and El Real Nursery site	under construction	2611 ECR- 66k sq ft 2621 ECR- no record of building sq ft 2635 ECR- 6,480 sq ft 2645 ECR- 21,635 sq ft 2655 ECR- in phase	CT	Regional Mixed Use	Rezoning	MND	5 stories	TBD	Pre-Application
PLN2013-09665 (Extreme Networks Site)	Yen Chen (408) 615-2455	2/7/2013	Irvine Co.	3515-3585 Monroe St. Corner of Lawrence Exp. And Monroe	New project submitted by Irvine Co. 825 housing units and 40,000 square feet of retail	under construction	Existing One and Two-story Industrial Office Buildings	MP	Regional Mixed Use	PD Rezone, D.A., Map, Architectural Review, potential GPA	EIR			Turnover/Extreme Networks property in escrow to Irvine co. 9-12
PLN2014-10256 et al	Yen Chen (408) 615-2455	5/7/2014	Irvine Co.	2620 Augustine Drive	General Plan Amendment #80 from High Intensity Office/R&D to Community Commercial [Retail Center] and Light Industrial to High Intensity Office/R&D [Office Phase II & III]; Rezone from Planned Development (PD) to Planned Development (PD) [Retail Center]; and from Light Industrial (ML) to Commercial Park (CP) [Office Phase II & III] to allow the construction of up to 1,243,300 square feet of office space and up to 125,000 square feet of retail space for a total (inclusive of Office Phase I) of up to 2,000,100 square feet of development; Approval of Development Agreement Amendment No. 2	under construction				PD Rezone, D.A., Map, Architectural Review, potential GPA				
PLN2014-10201	Payal Bhagat (408) 615-2458	2/5/2014	Applied Materials	3303 Scott Blvd.	New three-story office building at approximately 78,000 square feet. Design review and initial study required.									
PLN2012-09113	Payal Bhagat (408) 615-2458	3/11/2012- Revisions needed, Arch design and site planning deficiencies	Silicon Sage Builders	1460 Monroe Avenue 269-03-007, 008, 142 & 143	Rezone from CT to PD to construct a 4-story mixed use development with 1,800 sq.ft. of ground floor retail and 18 residential units above; 43 surface parking spaces	2013	2,500	CT	Community Mixed Use	Rezoning to PD	MND	35	TBD	submitted/CEQA review TBD
PLN2013-09799	Debby Fernandez (408) 615-2457	5/2/2013- continued from CC meeting of Dec. 2013 due to potential litigation	Prometheus	45 Buckingham and 66 Saratoga	GPA #76 from Community Mixed Use to High Density Residential & Rezone from CT to PD to construct a four-story 222 unit multi-family residential development with wrap parking structure w/ 375 on-site parking spaces in conjunction w/ demo of (e) commercial building (CEQ2013-01157)	site work commenced		CT	neighborhood mixed use	GPA, rezone, EIR	TBD	4 stories	PER GPA	ADEIR UNDER PREP

City of Santa Clara Approved and Pending Projects List for Traffic Impact Analysis

PLN File No.	Project Planner	Approval Date	Project	Location and APN	Description	Anticipated year built (for TIA purposes)	Existing Square footage	Current Zoning	Current GP	Proposed Entitlements (i.e. Rezoning/Variance/CUP/DA/Map etc.)	Environmental Review (i.e. EIR, MND)	Proposed Maximum Building Height	Proposed Maximum Building Coverage	Status of Project (i.e. ADER under review, PC scheduled for _____ etc.)
PLN2012-09096; (CEQ2012-01136 MND)	Debby Fernandez (408) 615-2457	6/1/2013 PC rec approval on Jan 15, 2014	U-Haul and Self Storage	2121 Laurelwood APN 104-14-153	Reincub PD and Rezone from ML to allow U-Haul facility and self storage business	under construction	remodel and expansion of an existing 100,000 sq.ft. furniture retail/warehouse building	PD	Low Intensity Office RSD	Rezone	EIR and TIA	8 stories	TBD	Second admin draft of EIR w/comments due on Oct. 12 by staff
PLN2010-08137	Jeff Schwik	Filed June 2013	David Tymn (at Mozart Dev)	3051 Homestead Road APN: 290-245-001	Application for Rezone from A to PD for the demolition of an existing 5.5 residence, and replacement with 8 detached homes	under construction	na	A	Low Density Residential	PD Rezoning, Map, Arch. Review for 8 detached homes	td (Cat Ex7)	2 Stories		Pre-Application
PLN2007-06715, CEQ2007-01051	Debby Fernandez	refiled in 2013 and revised and continued in 2014- approved 9-14	SOBRATO	4301 GAP	Rezone from PD & PD[ML] to PD to construct two high rise office buildings and one parking structure (CEQ2007-01051) construct up to 718,000 square feet of new office space in up to 1,018,000 square feet of office development; up to two, five-level parking structures with up to 3,360 total parking spaces.	1-3 years								
PLN2012-09027	Gloria Sciara (408) 615-2453	Application submitted 6-5-13	Dennis Chargin	865 Pomeroy Ave	Rezoning application to allow an additional 20-1 bedroom apartment units within an existing apartment complex with 51 current units	under construction		R3-2SD	Medium Density Residential (19-36 UPGA)	PD rezone	TBD			Meeting with owner and developer on Sept 20th to review final design for submittal of PD application
PLN2013-10107	Payal Bhagat (408) 615-2458	11/7/2013	Timo Mehner/co-site	3001 Coronado	Architectural Review to amend the previously approved CoreSite Campus master plan with two three story 92147 square foot buildings and other improvements such as bio-					AC approval				
PLN2012-09049	Payal Bhagat (408) 615-2458	8/9/2012	Timo Mehner	2920 Coronado 216-46-020	New Data Center	built				Rezoning from ML to PD/ rezoning application is being processed on behalf of Silicon Valley Power				
PLN2014-10381	Yen Chen	May-14	Irvine Co.	2620 Augustine Drive	125,000 square foot retail center (adjustment to PD with office campus)	Approved		PD		Rezoning to PD - readjustment of Office campus	addendum to EIR			
PLN2013-10184	Debby Fernandez (408) 615-2457	Filed 12/29/2013 Approved May 2014	BNP Leasing Corp	5450 Great America Parkway	Architectural review for Phase 2 of approved 6-story office building on an existing office/R&D site with 3 office buildings subgrade and surface parking (certified EIR).	2015				AC approval				
PLN2013-09965	Shaun Lacey	Filed 2013 Approved by CC Dec 2014	Charles McKeag	166 Saratoga Ave	Submit for GPA, Rezone and AC to allow 33 unit residential project (phase I) on 1.74 acre site. Total building area 24K sq. ft.	TBD	Single family residence & accessory buildings	CT??	Medium Density Residential (19-36 UPGA)	PD rezone	MND	3 stories	TBD	preapplication
PLN2014-10577 (GP) PLN2014-10579(REZONE) PLN2014-10579(VTM) PLN2014-10580 (3rd AM to DA) CEQ2014-01181 (Addendum to EIR)	Yen Chen (408) 615-2455	8/14/2014	Irvine Co. Carlene Matchniff	2520 Augustine Drive, 3393 and 3333 Octavius Drive APNs 216-45-036, 37, 38, 024, 025	Submit for GPA, Rezone and AC to allow 33 unit residential project (Phase II and III- see a. Two additional parcels are proposed to be added to the recently approved SCSQ Project. Addendum to the EIR and Amendment to Development Agreement is part of this proposal. The Office Sites proposed will not exceed the 2009 Project. Office Phase II and III are proposed to consist of 6-8 story office buildings with associated surface and structured parking at a ratio of 3.3/1000. Vesting Tentative Parcel Map proposal combines 6 parcels to create 3 parcels (See Drawings). Street bub at Augustine Drive and Octavius Drive is proposed to be replaced with standard curb.	1-3 years				PD Rezone, D.A. Amendment, Map, Architectural Review, GPA, VTM	Addendum to previously adopted EIR			
PLN2012-09391	Payal Bhagat (408) 615-2458	PC rec for approval 10/22/14 CC scheduled for January 2015	Silicon Valley Builders	1313 Franklin Street	Multifamily Residential project with 46 units and 16K or retail space and 4 stories	1-2 years		TBD		Rezone or AC, depending upon development design and access	TBD			Multiple revision needed to Arch design and utility accommodation 8-22-12/ CC Presentation for concept on 9-25-12. Outreach meeting held on 9-20-12.
PLN2013-09881	Payal Bhagat (408) 615-2458	6/18/2013 Approved by AC on 10-1-2014	Timo Mehner	3001 and 3032 Coronado 216-26-040	AC and DA for two new data centers along vacations of a portion of Coronado Drive	2013-14	50,400	ML	Light Industrial	Architectural Approval				
PLN2014-10754	Shaun Lacey	14-Oct	DH family Partnership	750 Walsh	New 57K industrial warehouse building and surface parking and site improvements	1-2 years	td- demolition of							
PLN2013-10046	Jeff Schwik	Submitted 9/25/2013 Approved 11/19/2014	TI and ARC	2930 Corvin Drive	Architectural Review to convert an existing industrial building into a data center (2.5MW energy use)	2014	20,000	ML	Light Industrial	ARC and TI approval. Proposed 2.5 or less MW of power requested- Cat Ex				

City of Santa Clara Approved and Pending Projects List for Traffic Impact Analysis

PLN File No.	Project Planner	Approval Date	Project	Location and APN	Description	Anticipated year built (for TIA purposes)	Existing Square footage	Current Zoning	Current GP	Proposed Entitlements (i.e. Rezoning/Variance/CUP/D.A./Map etc.)	Environmental Review (i.e. EIR, MND)	Proposed Maximum Building Height	Proposed Maximum Building Coverage	Status of Project (i.e. ADEIR under review, PC scheduled for _____ etc.)
PLN2014-10628	Yen Chen	Approved 9-24-14	Orade	4090 Network Circle and 4100 Network Circle	Commission of one new 3-story building and one new single story building with associated site improvements to an existing office campus.	1-2 year	100/300	FD	R and 17/193	Architectural approval				
PLN2014-10770	Yen Chen	Submitted on 11/1/2014. Approved by PC 2/10/15	Cogswell College	5302 Betsy Ross Drive	Cogswell Polytechnical College - private educational institution	2015	44K (existing)			Use Permit				
PLN2013-09854	Debby Fernandez (408) 615-2457	submitted 6/3/2013 Approved 11/13	James Salata	2680 Scott Blvd./224-10-110	New 20,000 square foot office building new landscape and parking improvements	2014		MH	Low Intensity Office R&D	Architctural approval				
Pending Projects- Last updated 3-2-15														
PLN File No.	Project Planner	submit date and status	Applicant	Location and APN	Description	Anticipated year built (for TIA purposes)	Existing Square footage	Current Zoning	Current GP	Proposed Entitlements (i.e. Rezoning/Variance/CUP/D.A./Map etc.)	Environmental Review (i.e. EIR, MND)	Proposed Maximum Building Height	Proposed Maximum Building Coverage	Status of Project (i.e. ADEIR under review, PC scheduled for _____ etc.)
PLN2015-10980	Yen Chen	Submitted 2-27-15	Irvine Company	575 Benton Street multiple parcels	Mission Towne Center Mission Town Center- 5-story mixed use project consisting ground floor 25,942 sf commercial space and 417 apartments on approximately 6.42 acres	2016-2020	varies- SFD, commercial etc	varies	Station Area Plan	General Plan Amendment, Rezoning, parcel map	EIR			
PLN2015-10968	Shaun Lacey	Submitted 2-24-15	Pinn Bros	1890 El Camino Real APN 269-01-081, 82 Corner of Pierce and ECR	Pre-application for 28 townhome project	2017-18	Small office area with open used car lot	CT	Community Mixed Use	Rezone, ARC review, TSM	EIR			
PLN2015-10937	Payal Bhagat (408) 615-2458	Feb-15	Johnathon Fearn/Summerhill Homes	3505 Kiefer Road APN 216-34-070	Development of 996 residential units with 37,000 square foot retail and associated open space, landscaping, parking and other improvements as part of the Lawrence Station Area Plan.	2-5 years	TBD site is 3.89 acres	ML	Light Industrial	Rezone, Possible DA, Specific plan approval, ARC review	EIR			
PLN2015-10888	Shaun Lacey	Jan-15	Westfield Valley Fair	2655 Stevens Creek Blvd portion of the existing Westfield Valley Fair	New Movie Theater complex and new retail tenant space and free standing bank bldg.	2016	77K		Regional Commercial	Use Permit for a new movie theater, and Variance to allowable building height, Shopping Mall, and the new construction of 102,210 square foot of commercial building area	Addendum to EIR?			
PLN2014-10487	Payal Bhagat (408) 615-2458	Jun-14	SCU Steve Brodie	455 El Camino Real	Re-use of existing office building for SCU for graduate studies off-campus instruction/occupation	2015-16	75,000			UP	Cat Exemp- Reuse of existing building			
PLN2015-10890, 10900, 10901, 10902, 10903, 10904	Yen Chen	Jan-15	Irvine	3265 Scott Blv (2600 Augustine) APN APNs: 216-45-011 - 022-024-025-028; 216-29-053 -112 and 216-46-003	Santa Clara Square Mixed Use Project - phased project 100+ acres 2,000 housing units 40,000 sf retail added 30 acres parks/open		3283 Scott Blvd (216-45-011); 2600-2610 Augustine Dr, 3300-3380 Montgomery Dr & 3265 Scott Blvd (216-45-023); 3255 Scott Blvd & 2500		2025-36 Phase III General Plan High Density Residential (37-50 du/ac) Service, Parks, Public.	GPA, rezone, subdivision map				
PLN2014-10720	Jeff Schwik	10/14/2014- PCC done, and CMO office review, redesign project to allow open space and better site	Ivanovich	1525 Alivso Street	Pre-application for 42 unit townhouse project- 3 stories (next to Mission Inn motel)	2-3 yrs	n/a	ML	Community Mixed Use	Rezone	MND/TBD	3 Stories		
PLN2014-10828	Shaun Lacey	14-Dec	Summerhill	2230 El Camino Real	Pre-Application for the proposed demolition of existing commercial buildings, and the development of 164 apartment units	2 years	tbd- demolition of	CC	Regional Mixed Use	Rezone and GPA possible for no commercial	MND			
PLN2014-10765	Jeff Schwik	10/14/2014- CC study session Jan 15- application will proceed	Mehdi Shemza	1480 Main Street	Rezone to PD to allow a mixed use project with 12 residential apartments and 1,000 sq ft of retail on a approx. 15,000 square foot lot	3-Feb	vacant site	CC	Community Mixed Use	Rezone	Cat exempt/TFM project			
PLN2014-10744	Yen Chen	11/14/2014 CC Study Session complete Jan 2015	Rubicon Investments/	100 N. Winchester	pre-application for 60 unit senior apartment community - demolition of existing 3-story building	1-2 years	3 story building over podium approx. 84,000	OA	Regional Mixed Use	rezone and GPA	MND OR EIR			
PLN2014-10664	Yen Chen	revis	Jon Shank	1220 Memorex	Parcel Map and Arch review for self storage facility	2016	lot split for this development - proposed/vacant	ML	High Industrial	Parcel Map and Architectural approval				
PLN2014-10683	Payal Bhagat (408) 615-2458	Sep-14	Sobrato	2250 El Camino Real	Pre-application for 48 apartments- 3 floors over podium parking (Western Motel site)	2017	.98 acre	PD/Multi family	High Density Residential	Rezone/ARC approval				

City of Santa Clara Approved and Pending Projects List for Traffic Impact Analysis

PLN File No.	Project Planner	Approval Date	Project	Location and APN	Description	Anticipated year built (for TIA purposes)	Existing Square Footage	Current Zoning	Current GP	Proposed Entitlements (i.e. Rezoning/Variance/CUP/D.A./Map etc.)	Environmental Review (i.e. EIR, MND)	Proposed Maximum Building Height	Proposed Maximum Building Coverage	Status of Project (i.e. ADEIR under review, PC scheduled for _____ etc.)
PLN2014-1054	Debby Fernandez	Sep-14	Related	5155 Stars and Stripes Drive 104-03-036 & 103-104-01-102, 107-01-039 & 097-01-073	City Plan - Related to project for redevelopment of five parcels that include Santa Clara Golf & Tennis Club, BMX track, Fire Station #10, and former City landfill for varied intensities of up to 5,000,000 square feet of office, commercial and residential development along with construction of parking facilities, provision of open space, and public and transit infrastructure improvements and/or relocations. See attached Master Community Plan for detailed description and concept plan. Actions to be considered include:	Start 2017 phased over 20 years	lot area approx 13,000 square feet	P	Public Open Space	EIR, General Plan Amendment, Rezone, Tentative Map and/or Vesting Tentative Map, Development Agreement and/or Disposition Development Agreement, Ground Lease, and Architectural Review.				
PLN2014-10614	Jeff Scheib	Nov-13	Kent Anderson	2891 Hiconescal Rd APN 296-39-080	Pre-Application review of the proposed implementation of a single family residential detached garage with a three-car garage and a detached two-car garage.	2015/16								
PLN2014-10407	Yen Chen	Jun-14	Montana Love Enterprises (Central Grocery LLC)	3120 Stars and Stripes Drive APNs: 99-403-036, 038, portion of 039	Pre-Application for construction of up to 700,000 sq. ft. of office, retail, restaurant, and hotel/pedestrian amenity areas, attached/podium parking (possibly connected to existing City parking structure) site, landscape improvements, and expansion of proposed parcels into the existing right of way.	2016				EIR				
PLN File No 2014-10183	Shaun Lacey	8/1/2014 - Rec'd denied to CC on 9-10-15	Eli Engelman	990 Wren	Rezone from R1-SL to PD to construct 6 new detached 2-story single family residences w/attached garage in conjunction with demo of existing sfr (PLN2014-10386 Map & CEG02014-01177)									
PLN2014-10320	Debby Fernandez (408) 615-2457	Jul-14	JOMA Studio architects	1701 Lawrence Road	Rezone from PD (R3-18D) to PD to redevelopment of an existing developed parcel with 8 attached sfr (CEQA to be determined)	1 year	two sfrs							
PLN2015-10041	Shaun Lacey	submitted on 9/25/14 denied by CC Feb. 2015	Maria Polanco/Dori Marhamat	1073 Pomeroy 290-09 070	application for 5 unit townhome project.	2014/15	2200 single family home	R3-18D	Low Density Residential	TBD/PO				
PLN2013-09887	Shaun Lacey	6/20/2013	Jerry Mangione	2255 The Alameda	pre-application for rezoning of small parcel to include one living unit and office			CT	Community Mixed Use	Rezoning to PD	MND	no change	no change	pre-Application/more detail needed
PLN2013-09888	Shaun Lacey	submitted 2/22/2013	Applied Materials	3303 Scott	Pre-application for new 80,000 square foot building with underground parking/Replaced with proposal for service commercial use in existing	2014-2016	36,340	ML	Light Industrial	Architctural approval or PD rezone				
PLN2013-09730	Payal Bhagat (408) 615-2458	3/12/2013	Jane Vaughn	3333 Scott Blvd	Expansion of previous approval from to allow 581,000 additional sq ft of office buildings for a total of 1.2m sq. ft.	2013-14			PD	supplemental CUP to allow the development of 1,316,000 square foot office/retail space. The project was approved to develop 735,000 sq. ft. office/retail space spread over five buildings (PLN2011-08759 and 08760).				
PLN2013-09817	TBD	5/6/2013	Mike Sullivan for Claiton Homes	2490 and 2500 El Camino Real	Preliminary application: Development of 8 contiguous parcels (2490 and 2500 ECR) totalling 8.4 acres with a 100% residential project consisting of up to 352 multifamily units and 19 townhomes (at approx. 60 du/ac) & will require GPA's, application of discretionary policies to increase max. density, rezoning, map(s), architectural & environmental review	2-5 years	Mariani's hotel and restaurant property	CT	Community Mixed Use	PD REZONE, D.A., Map, Architectural Review, GPA, and EIR	EIR			
PLN2012-09642	Gloria Sciarra (408) 615-2453	PC meeting for 12/10/14 (Rec'd approval) CC in February	Rezone and Redevelopment of site	3700 El Camino Real	Gateway Santa Clara (formerly Kohls Site) Mixed use development - Redevelopment of entire site 87K retail/commercial and 476 housing units (apartments)	2014	100,000 -Kohls store			Rezone/Subdivision Map/AC approval 475 retail dwelling units and 86,000 square feet of retail space	EIR			EIR not started yet/final design to be submitted with development applications. One community meeting held to date.
PLN2014-10437	Jeff Schwik	Jun-14	Michael Fischer	820 Civic Center Drive APN 224-29-022	application for a 3 unit Townhome development (retention of one historic home)	TBD	15,100 sq. ft lot	ML						
PLN2015-10035	Parks and Recreation Dept	Feb-15	Swim Center at Central Park	909 Kieley Boulevard	International Swim Center (ISC) PRELIMINARY proposal at Central Park CIP project #3172; project includes the following components: ISC Community Recreation Center	4-10 years	TBD			Existing swim center with bleachers and accessory				

The Hamptons Striping Proposal

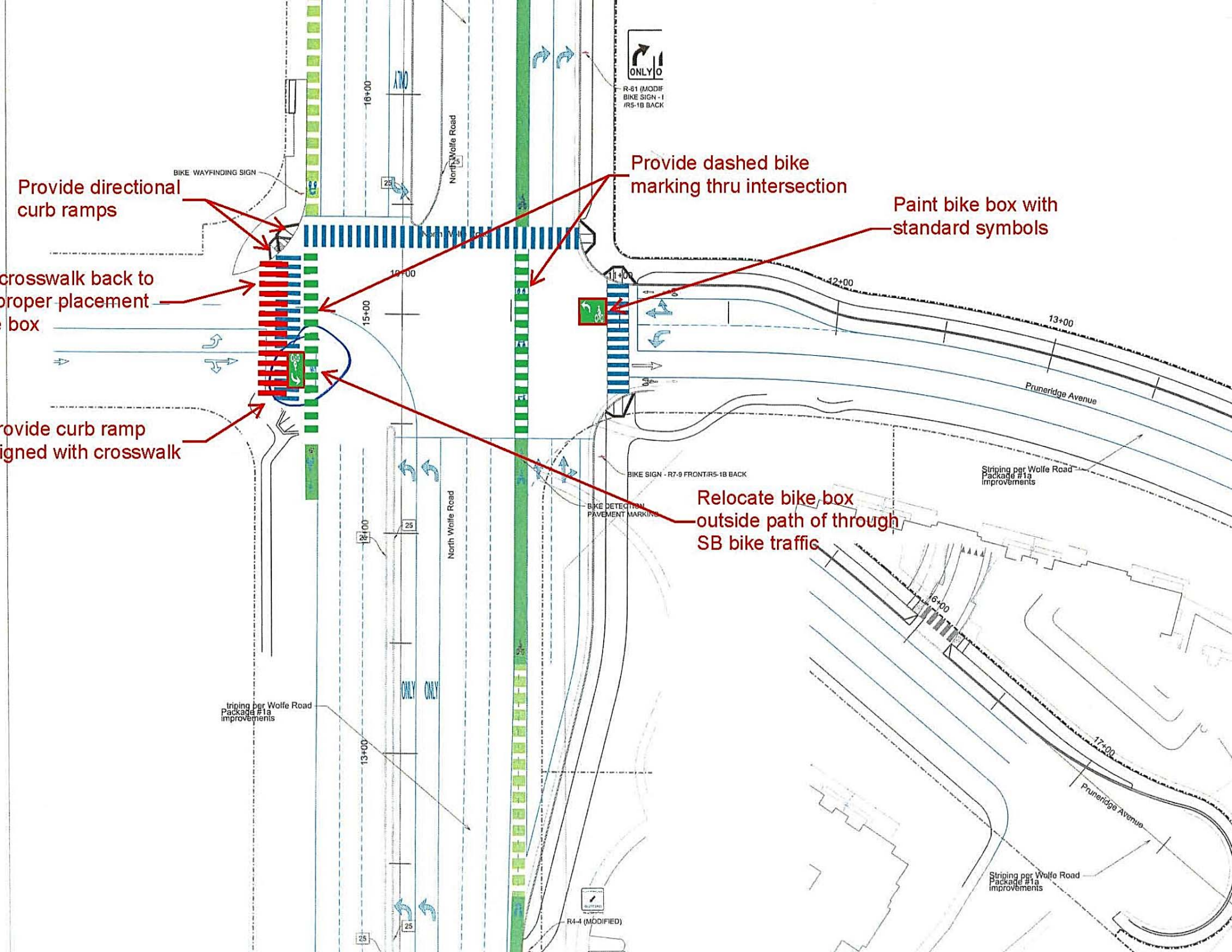

Provide directional curb ramps

BIKE WAYFINDING SIGN

crosswalk back to proper placement of box

provide curb ramp aligned with crosswalk



R-81 (MODIF BIKE SIGN - 1) / R5-1B BACK

Provide dashed bike marking thru intersection

Paint bike box with standard symbols

BIKE SIGN - R7-9 FRONT/R5-1B BACK

Relocate bike box outside path of through SB bike traffic

BIKE DETECTION PAVEMENT MARKING

Striping per Wolfe Road Package #1a improvements

Striping per Wolfe Road Package #1a improvements

R4-4 (MODIFIED)

Striping per Wolfe Road Package #1a improvements

18+00

17+00

16+00

15+00

14+00

13+00

12+00

11+00

12+00

13+00

16+00

17+00

North Wolfe Road

North Wolfe Road

Pruneridge Avenue

Pruneridge Avenue

